

HD2205.2

HD2206.2

HD2256.2



Our instruments' quality level is the results of the product continuous development. This can bring about differences between the information written in this manual and the instrument that you have purchased. We cannot entirely exclude errors in the manual, for which we apologize.

The data, figures and descriptions contained in this manual cannot be legally asserted. We reserve the right to make changes and corrections without prior notice.

HD2205.2 Dual pH - Temperature
HD2206.2 Conductivity - Temperature
HD2256.2 pH - Conductivity - Temperature

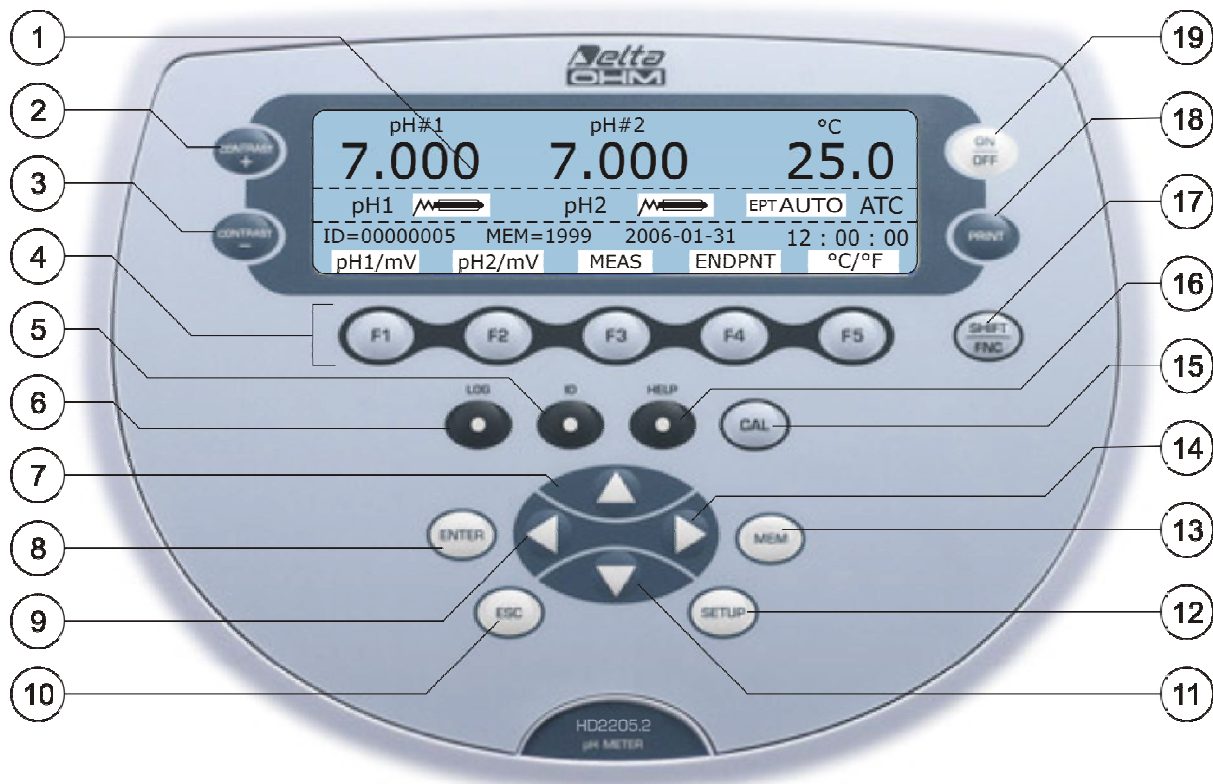

1. LCD Display
2. **CONTRAST+** key, allows to increase the display contrast.
3. **CONTRAST-** key, allows to decrease the display contrast.
4. Function keys **F1**, ..., **F5**.
5. **ID** key, allows to set the sample identifier number.
6. **LOG** key: starts and ends the saving of the data in the internal memory.
7. **▲** key: in the menu, increases the current value.
8. **ENTER** key: in the menu, confirms the current selection.
9. **◀** key: in the menu, moves the cursor leftwards.
10. **ESC** key: in the menu, cancels the operation in progress without making changes.
11. **▼** key: in the menu, decreases the current value.
12. **SETUP** key: allows access to the menu.
13. **MEM** key: stores the currently displayed screen.
14. **▶** key: in the menu, moves the cursor rightwards.
15. **CAL** key starts the pH electrode, conductivity probe calibration procedure.
16. **HELP** key: shows a description of the instrument main functions on the display.
17. **SHIFT/FNC** key: enables the secondary functions linked to the F1, ..., F5 keys.
18. **PRINT** key: prints the data on the current screen. It uses the serial communication port RS232C or the USB port.
19. **ON-OFF** key: turns the instrument on and off.

HD2205.2 connectors: Dual pH - Temperature

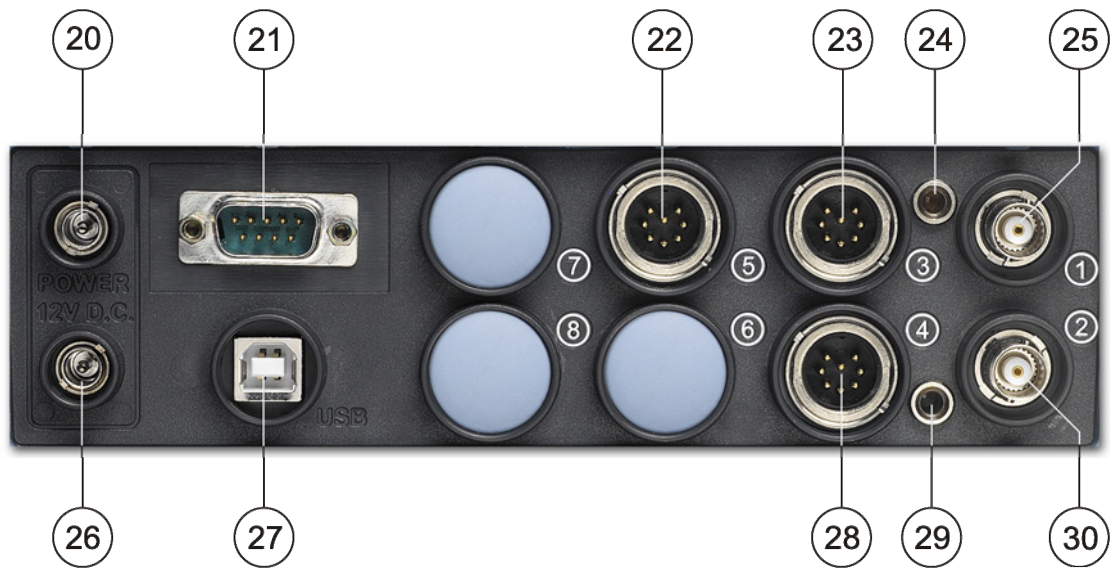

20. Power supply input 12Vdc for the Ø 5.5mm - 2.1mm connector. Positive at centre.
21. RS232C serial port, sub D 9-pole male connector.
22. 8-pole DIN45326 connector, input for Pt100 temperature probes with SICRAM module, 4 wire direct Pt100 probes, 2 wire direct Pt1000 probes ⑤.
23. 8-pole DIN45326 connector, for the combined pH/mV/temperature electrode with SICRAM module - channel 1 ③.
24. Socket for Ø 4mm standard plug for the reference electrode pH/ISE - channel 1.
25. BNC connector for the pH/mV electrode - channel 1 ①.
26. Auxiliary power supply output 12Vdc/200mA max. for the stirrer - Ø 5.5mm - 2.1mm connector.
27. USB 2.0 connector - type B.
28. 8-pole DIN45326 connector, for the combined pH/mV/temperature electrode with SICRAM module - channel 2 ④.
29. Socket for Ø 4mm standard plug for the reference electrode pH/ISE - channel 2.
30. BNC connector for the pH/mV electrode - channel 2 ②.

HD2206.2 connectors: Conductivity - Temperature

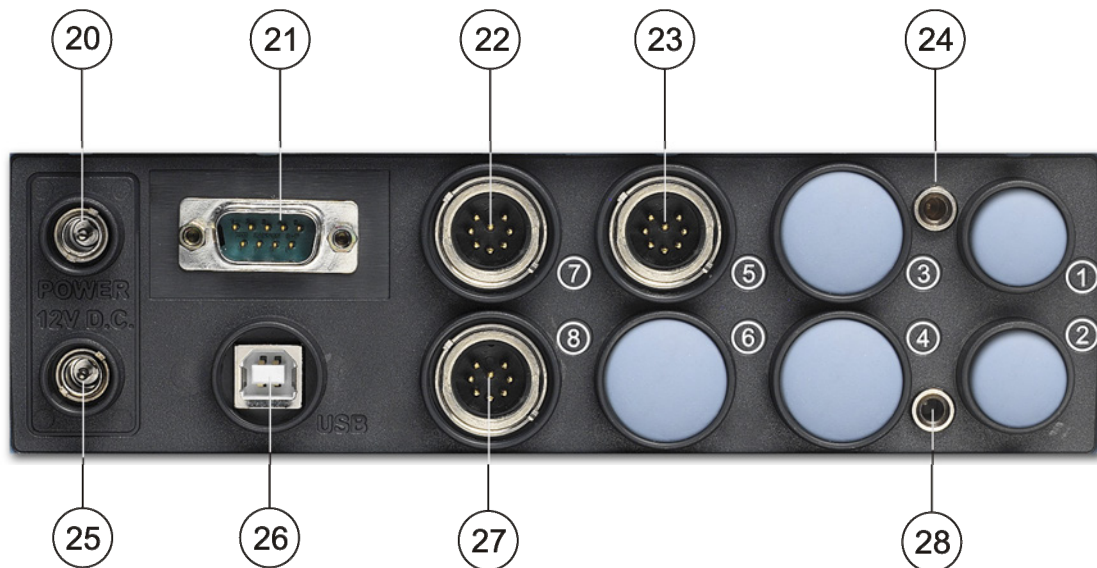

20. Power supply input 12Vdc for the \varnothing 5.5mm - 2.1mm connector. Positive at centre.
21. RS232C serial port, sub D 9-pole male connector.
22. 8-pole DIN45326 connector, input for combined 4-ring or 2-ring conductivity/temperature probes **complete** with SICRAM module ⑦.
23. 8-pole DIN45326 connector, input for Pt100 temperature probes with SICRAM module, 4 wire direct Pt100 probes, 2 wire direct Pt1000 probes ⑤.
24. Not used.
25. Auxiliary power supply output 12Vdc/200mA max. for the stirrer - \varnothing 5.5mm - 2.1mm connector.
26. USB 2.0 connector - type B.
27. 8-pole DIN45326 connector, input for combined 4-ring or 2-ring conductivity/temperature probes **without** SICRAM module ⑧.
28. Not used.

HD2256.2 connectors: pH - Conductivity - Temperature

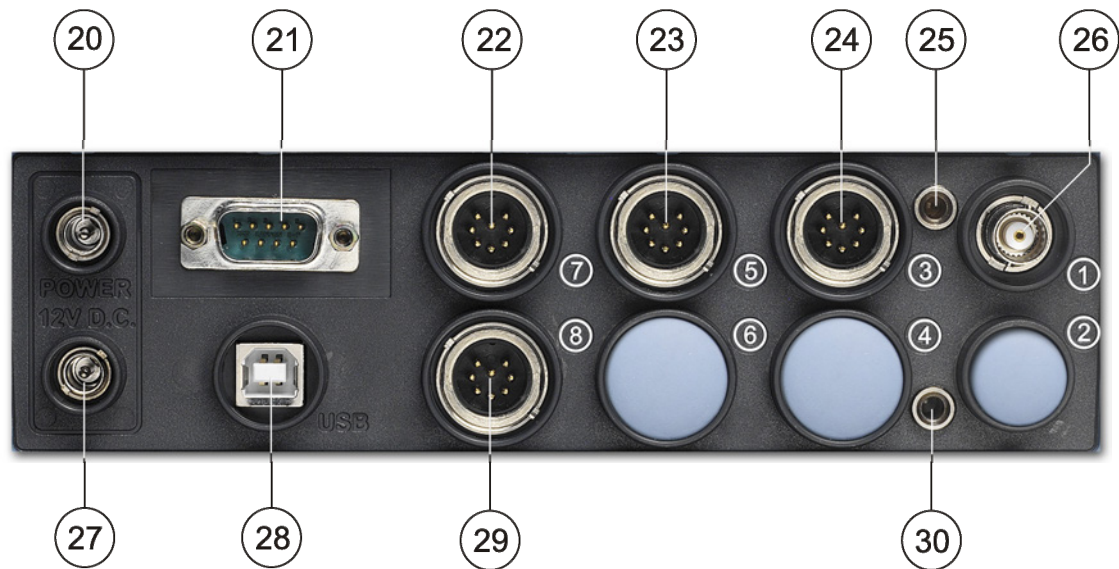

20. Power supply input 12Vdc for the \varnothing 5.5mm - 2.1mm connector. Positive at centre.
21. RS232C serial port, sub D 9-pole male connector.
22. 8-pole DIN45326 connector, input for combined 4-ring or 2-ring conductivity/temperature probes **complete** with SICRAM module ⑦.
23. 8-pole DIN45326 connector, input for Pt100 temperature probes with SICRAM module, 4 wire direct Pt100 probes, 2 wire direct Pt1000 probes ⑤.
24. 8-pole DIN45326 connector, for the combined pH/mV/temperature electrode with SICRAM module - channel 1 ③.
25. Socket for \varnothing 4mm standard plug for the reference electrode pH/ISE.
26. BNC connector for the pH/mV electrode ①.
27. Auxiliary power supply output 12Vdc/200mA for the stirrer - \varnothing 5.5mm - 2.1mm connector.
28. USB 2.0 connector - type B.
29. 8-pole DIN45326 connector, input for combined 4-ring or 2-ring conductivity/temperature probes **without** SICRAM module ⑧.
30. Not used.

INTRODUCTION

The **HD2205.2**, **HD2206.2** and **HD2256.2** are laboratory instruments for electrochemical measurements: **pH**, **conductivity** and **temperature**. They are fitted with a large backlit LCD display.

The **HD2205.2** is fitted with two BNC inputs for **pH**, **mV**, **redox potential** (ORP) measurement using pH, redox electrodes or separate reference electrodes, and two inputs for pH/temperature probes complete with SICRAM module.

The **HD2206.2** measures **conductivity**, liquid **resistivity**, **total dissolved solids** (TDS) and **salinity** using combined 4-ring and 2-ring conductivity/temperature probes. The conductivity probes can have a direct input or a SICRAM module; the inputs are separate.

The **HD2256.2** measures **pH**, **mV**, **redox potential** (ORP) using pH, redox electrodes or separate reference electrodes; **conductivity**, liquid **resistivity**, **total dissolved solids** (TDS) and **salinity** using combined 4-ring and 2-ring conductivity/temperature probes. The inputs are separate. One for the 4-ring and 2-ring direct probes, the other for the probes fitted with SICRAM module.

The instruments have an input for the immersion, penetration or contact **temperature** probes. The sensor can be a Pt100 or Pt1000.

- The pH electrode calibration can be carried out on one or five points, and the calibration sequence can be chosen from a list of 13 buffers. The temperature compensation can be automatic or manual.
- The calibration of the conductivity probe can be automatic, by recognition of standard solutions: 147 μ S/cm, 1413 μ S/cm, 12880 μ S/cm, 111800 μ S/cm or manual with different solutions.
- The pH, conductivity and temperature probes are fitted with a SICRAM module, with the factory calibration settings already being memorized inside.

The devices of the HD22... series are **dataloggers**. They memorize up to 2,000 samples of:

- pH or mV and temperature the HD2205.2,
- conductivity or resistivity or total dissolved solids or salinity and temperature the HD2206.2,
- pH or mV, conductivity or resistivity or total dissolved solids or salinity and temperature the HD2256.2.

The data can be transferred from the instrument connected to a PC via the RS232C serial port or the USB 2.0 port. The recording parameters can be configured using the menu.

The RS232C serial port can be used for direct printing of the data using a 24 column printer (*S'print-BT*).

The instruments equipped with the Bluetooth **HD22BT** option, can send the data to a PC fitted with the USB/Bluetooth HD USB.KL1 converter, to a printer with a Bluetooth *S'print-BT* interface, or to a PC fitted with a Bluetooth input, without the need of any connection.

The **DeltaLog11** dedicated software allows management and configuration of the instrument, and data processing on the PC.

The instruments have IP66 protection degree.

If not otherwise specified, this manual's descriptions are intended to be applicable to all models.

DISPLAY DESCRIPTION

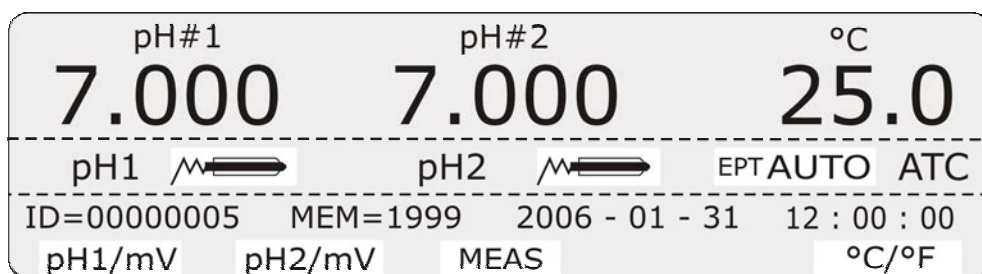

HD2205.2

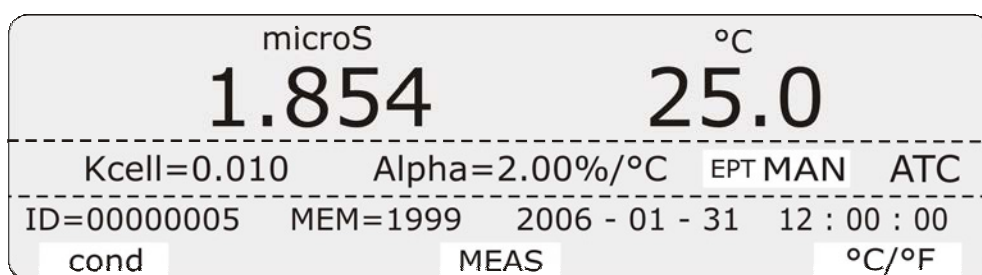

HD2206.2

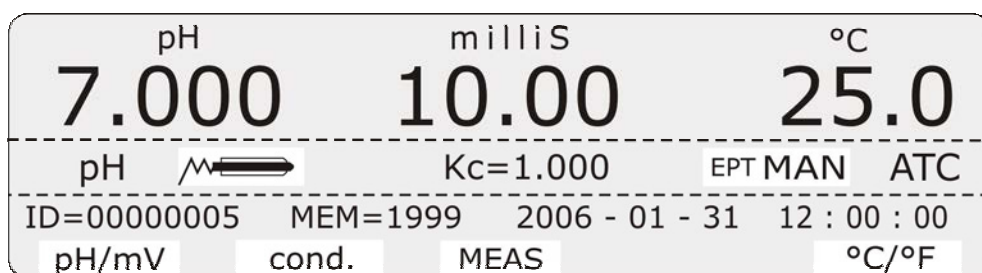

HD2256.2

The above appears when you turn the instrument on.

The display is backlit. The contrast level is adjusted using CONTRAST+ and CONTRAST-.

The display has three lines described below:

First line

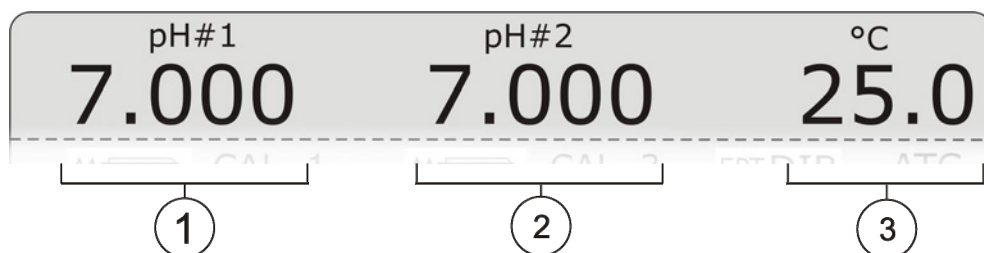

HD2205.2

It indicates, from left to right:

1. The pH or mV value measured by the electrode connected to the BNC input ①, or by the SICRAM pH probe connected to the input ③, (pH#1 o mV#1),
2. The pH or mV value measured by the electrode connected to the BNC input ②, or by the SICRAM pH probe connected to the input ④, (pH#2 o mV#2),

- The temperature value used to compensate the pH measurements (for a detailed description, see the chapter dedicated to temperature on page 36).

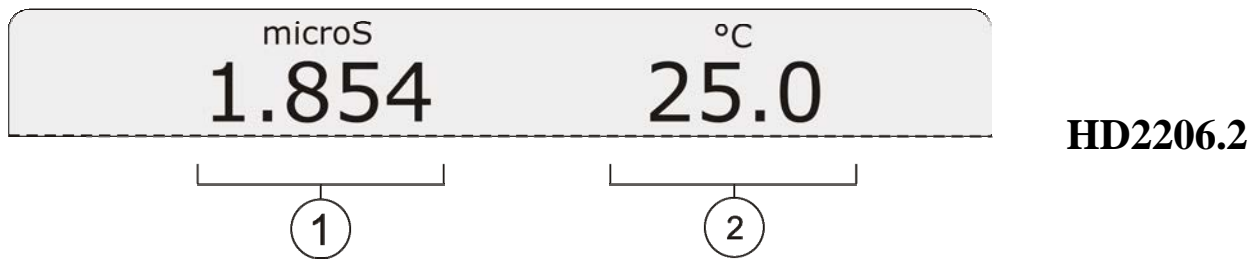

It indicates, from left to right:

- The conductivity, resistivity, TDS, NaCl concentration measured by the conductivity probe, **with SICRAM module**, connected to the input ⑦, or by the direct probe, **without SICRAM module**, connected to the input ⑧,
- The temperature value used to compensate the conductivity measurements (for a detailed description, see the chapter dedicated to temperature on page 36).

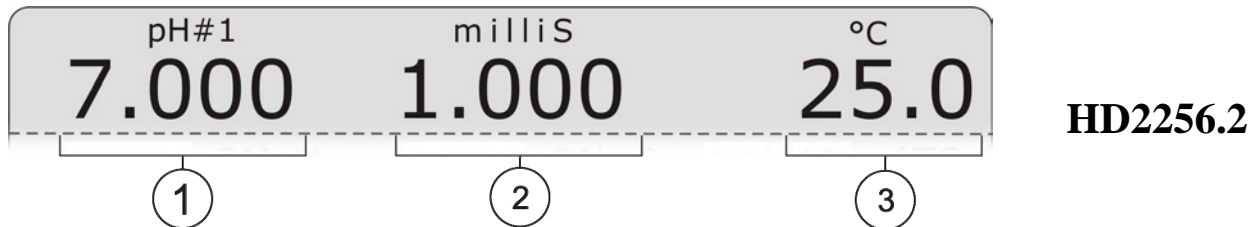

It indicates, from left to right:

- The pH or mV value measured by the electrode connected to the BNC input ①, or by the SICRAM pH/temperature probe connected to the input ③,
- The conductivity, resistivity, TDS, NaCl concentration measured by the conductivity probe, **with SICRAM module**, connected to the input ⑦, or by the direct probe, **without SICRAM module**, connected to the input ⑧,
- The temperature value used to compensate the pH and/or conductivity measurements (for a detailed description, see the chapter dedicated to temperature on page 36).

Central line

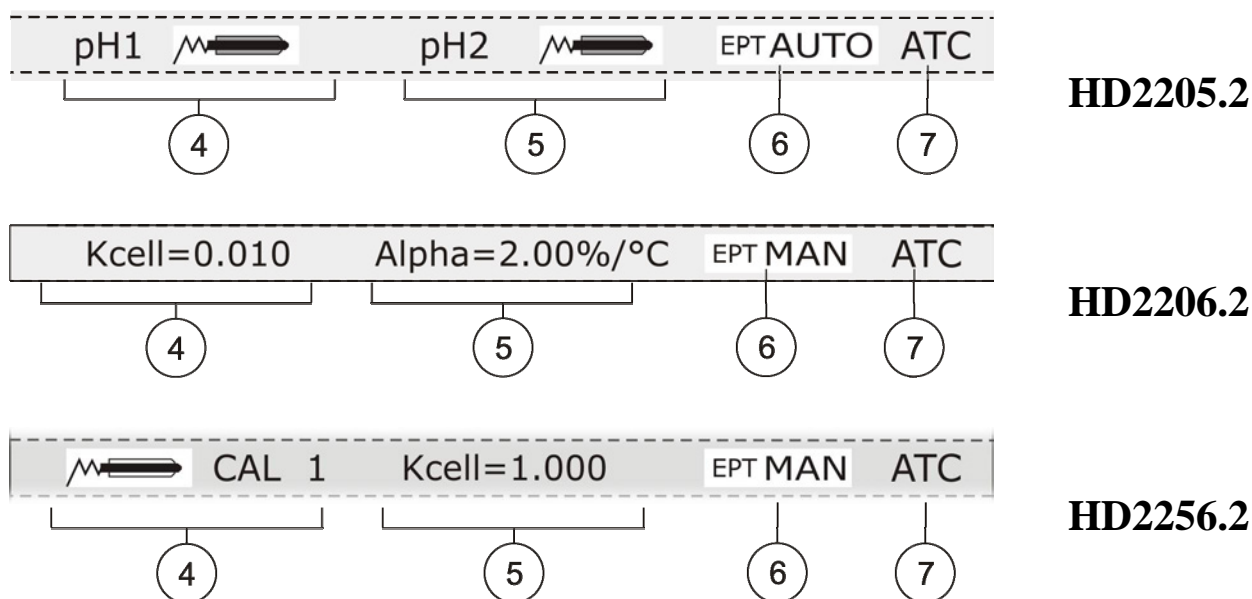

It indicates, from left to right:

4. In models HD2205.2 and HD2256.2: The symbol indicates the quality of the pH electrode connected to the inputs ① or ③, or the CAL blinking message if the probe connected to the pH input is not calibrated. The symbol shows an electrode that gets “empty” as its efficiency decreases.

In the HD2206.2 instrument, the cell constant value of the conductivity probe connected to inputs ⑦ or ⑧. It has up to 4 different calibration points and nominal cell constant corrections. **The displayed value is referred to the calibration point at 1413µS/cm.**

5. In the HD2205.2 instrument, the symbol indicates the quality of the pH electrode connected to the inputs ② or ④, or the CAL blinking message if the probe connected to the pH input is not calibrated.

In the HD2206.2 instrument, the temperature coefficient α_T

In the HD2256.2 instrument, the cell constant value of the conductivity probe connected to inputs ⑦ or ⑧. It has up to 4 different calibration points and nominal cell constant corrections. **The displayed value is referred to the calibration point at 1413µS/cm.**

6. The EPT (End Point) symbol indicates the display mode. The mode selection is done using the ENDPNT function key (SHIFT/FNC key >> F4 key). When EPT is blinking, the measurement is updated on the display; when it is fixed, the measurement is “frozen”. For a new measurement, press F3 = MEAS.

EPT = **DIR**: The instrument operates in **continuous view mode**. In this mode the displayed measurement is updated every second (standard mode).

EPT = **MAN**: The displayed measurement is continuously updated until F3 = MEAS is pressed. During the measurement update, the EPT-MAN symbol is blinking. For a new measurement, press MEAS.

EPT = **TIME**: The measurement is frozen after a set time of 8 seconds. For a new measurement, press MEAS.

EPT = **AUTO**: The instrument performs the measurement, and when it stabilizes the EPT-AUTO symbol stops blinking. For a new measurement, press MEAS.

In the following figure you can see an example of the measurement process with the **EPT AUTO** function enabled. After setting the EPT = AUTO function using the F4 key, the electrode is immersed into a liquid. To perform the measurement, press MEAS. the EPT symbol blinks to indicate that the measurement is in the stabilization phase. In the stretch indicated by 1, the measurement remains within a stability range for 8 seconds: at the end of this interval (point 2), the instrument freezes the measurement, presenting the final stable value. The EPT AUTO symbol stops blinking.

For a new measurement, press MEAS.

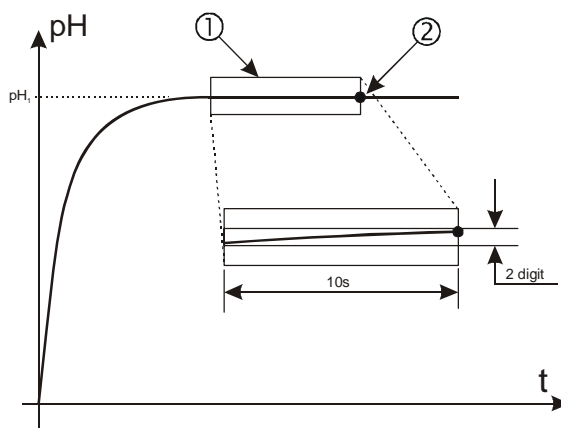

The reference stability range has a span of 2 digits.

When recording is started (Logging), the ENDPNT function switches automatically to DIR.

7. ATC or MTC indicate the temperature compensation type being used.

ATC means automatic compensation: If the temperature probe is present, compensation is carried out according to this probe, or according to the temperature detected by a combined probe, if present. In this case, you cannot modify the manually input temperature value.

MTC means manual compensation: there are no temperature sensors; the temperature used for compensation is typed using the keyboard. Press the “F5 - °C/°F” key once to modify its value: the message ③ blinks. Use the ▼ and ▲ arrows to set the desired value and confirm with ENTER. The display stops blinking, and the temperature displayed is used for compensation.

If the temperature probe is not present, in order to change the unit of measurement between °C and °F, it is necessary to press the F5 = °C/°F key **twice**.

Bottom line

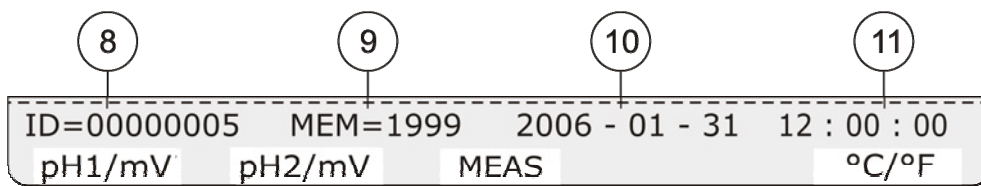

The following is reported in the bottom line:

8. **Identifier of the sample being measured:** The automatically increased progressive number associated with the PRINT and MEM functions. The identifier is indicated in the printout and in the recorded samples together with the date, time and measured values.
To set the number associated to the first sample, press **ID**, then use the ▼ and ▲ arrows to select the desired number: Confirm by pressing ENTER. This parameter can be modified only by the administrator (see page 21).
If the *EPT* option is set to *DIR* (see point 6 in this chapter), each time the PRINT or MEM key is pressed, the identification **ID** is increased by 1.
If the *EPT* option is set to *Auto, Man or Time*, pressing PRINT only causes the print to occur when the measurement has stabilized (*EPT* symbol still); until the measurement is frozen, it is possible to repeat the print at will, but the sample identifier number is not increased. This is useful when more labels concerning a single measurement must be printed with the same identification code, without increasing the code each time.
9. **MEM** reports the number of samples contained in the instrument's memory.
10. Current date expressed as year/month/day.
11. Current time expressed as hours/minutes/seconds.

Function keys

The bottom line is associated to the **F1**, ..., **F5** function keys. When you turn the instrument on, the following messages appear.

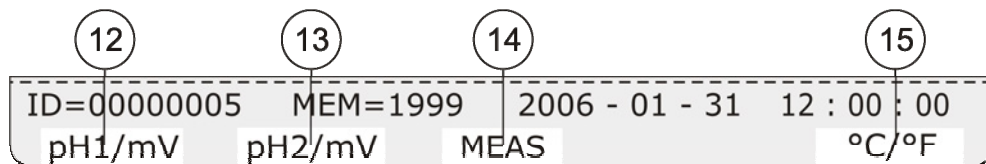

HD2205.2

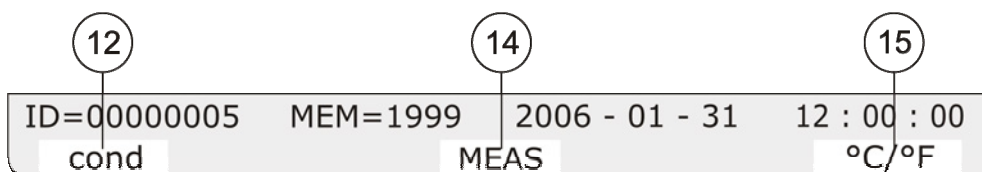

HD2206.2

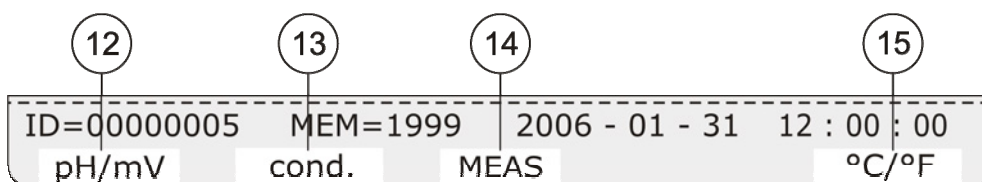

HD2256.2



12. **F1** - Models *HD2205.2* and *HD2256.2* - If you press it repeatedly, it changes the unit of measurement of the electrode connected to the BNC input ① or of the SICRAM pH probe connected to the input ③ between pH, mV, or no indication.
F1 - Model *HD2206.2* - If you press it repeatedly, it changes the measurement performed on the probe connected to the input ⑦ (SICRAM probe) or input ⑧ (direct probe without SICRAM), between conductivity, resistivity, TDS, NaCl concentration, or no indication.
13. **F2** - Model *HD2205.2* - If you press it repeatedly, it changes the unit of measurement of the electrode connected to the BNC input ② or of the SICRAM pH probe connected to the input ④ between pH, mV, or no indication.
F2 - Model *HD2206.2* – Function not enabled.
F2 - Model *HD2256.2* - If you press it repeatedly, it changes the measurement performed on the probe connected to the input ⑦ (SICRAM probe) or input ⑧ (direct probe without SICRAM), between conductivity, resistivity, TDS, NaCl concentration, or no indication.
14. **F3** Allows to carry out a new measurement, when the EPT = AUTO, MAN or TIME modes are selected.

15. **F5** = °C/°F: If the temperature sensor is present, the key changes the unit of measurement between °C or °F. If no temperature or combined temperature probes are present, the key allows manual input of the temperature value used for compensation and of the unit of measurement (°C or °F). See also point 7.

By pressing the **SHIFT/FNC** key, you can access the secondary functions linked to the F1, ..., F5 function keys.

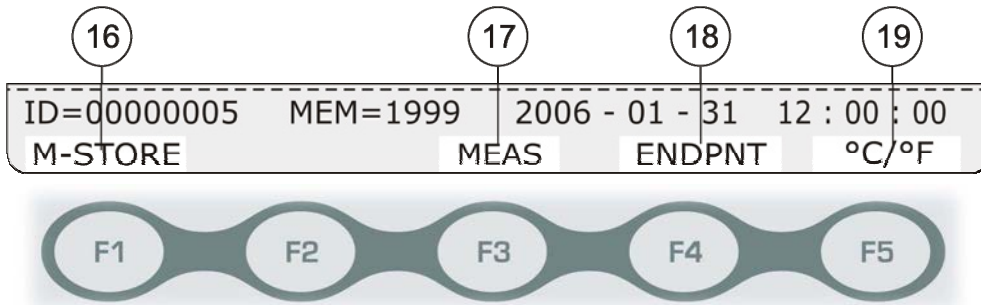

16. **F1** = **M-STOR** - Stores the current information. It performs the same function as the MEM key.
When EPT is different from DIR (see point 6), the logging is disabled until the measurement is stable: M-STOR is displayed only when the measurement is stable.
17. **F3** = **MEAS** - Allows to perform or repeat a new measurement, when the EPT = AUTO, MAN or TIME modes are selected (see point 6).
18. **F4** = **ENDPNT** - Selects the displayed measurement update mode (see point 6)
19. **F5** = **M-VIEW** - Allows to display the stored data or to clear the memory. See the details on page 49.

KEYBOARD DESCRIPTION

Each key specific function is described in detail below.



ON-OFF key

The instrument is turned on and off using the ON/OFF key. **Press this key for at least two seconds.** The turning on starts a self test including the detection of the probes connected to the inputs. **As the probes' identification and calibration data are captured upon turning the instrument on, it is necessary to connect them when the instrument is off. If a probe is connected and the instrument is on, it is necessary to turn it off and on.**

Finally, the instrument is set for normal measurement.

Once turned off, wait few seconds before turning it on to allow completion of the shut down routine.



PRINT key

It sends the displayed data to the serial RS232C or USB output.

If EPT = DIR, the identification **ID** is increased by 1 (see page 11).

Before starting the communication via the RS232C serial port, set the baud rate. To do so, select “*System Parameters >> RS232 Speed (Baud Rate)*” and select the maximum value equal to 115200 baud by using the arrows ▲ and ▼. Confirm by pressing ENTER.

The DeltaLog11 software for PC will automatically set the baud rate value during connection by reading it on the instrument. **If you are using a different program than DeltaLog11, be sure the baud rate is the same for both the instrument and the PC: the communication will only work in this way.**

If the instrument is connected directly to a serial printer, set the recommended baud rate for the printer. See the details on page 50.



CONTRAST+ key:

This key allows to increase the display contrast.



CONTRAST- key:

This key allows to decrease the display contrast.



...



Function keys F1, ..., F5

The function of the F1, ..., F5 keys is described by the message near each key in the bottom line of the display. A complete description of these keys is reported on page 12.



SHIFT/FNC key

The F1...F5 keys have two functions: the main and the secondary functions. By pressing the **SHIFT/FNC** key, you can toggle between the two functions.

LOG



LOG key

It starts and stops the logging of a data block to be saved in the instrument's internal memory. The data logging frequency is set in the “*System Parameters >> Logging Options >> Select Log Interval*” menu. The data logged between a start and subsequent stop represent a data block.

When the logging function is on, the “*NOW LOGGING!*” indication is displayed. Upon each recording, the identification ID and the MEM counter are increased by 1 (see page 11).

To end the logging, press LOG.

For the details see the chapter dedicated to recording on page 49.

ID



ID key

This key allows to input the value of the first sample ID associated with the PRINT function. Use the ◀ and ▶ arrows to select the value to be modified, and set the desired value using the ▲ and ▼ arrows. Modify the other values in the same way. At the end, confirm with ENTER. For the details, see the description on page 11.

This parameter can be modified only by the administrator (see page 21).

HELP



HELP key

It displays a short help on the instrument's main functions. Press ESC to go back to standard measurement. Use ENTER to browse the HELP items.



CAL key

Starts the pH electrodes, conductivity probe calibration procedure (see the chapter dedicated to calibration on page 25).



ENTER key

In the menu, the ENTER key confirms the current parameter.



ESC key

In the menu, the key clears or cancels the active function.



MEM key

It stores the displayed data.

The data refer to the following measurements:

- pH, mV and temperature for the HD2205.2;
- conductivity, resistivity, total dissolved solids, NaCl and temperature for the HD2206.2,
- pH, mV, conductivity, resistivity, total dissolved solids, NaCl and temperature for the HD2256.2,

The units of measurements are those selected on logging using the F1 and F2 function keys. For the details see the chapter dedicated to recording on page 49.



SETUP key

Using this button the instrument's menu can be accessed. See a detailed description on page 17.

MENU DESCRIPTION

The SETUP key is used to access the menu main screen. To select one item, use the arrow keys (▲ and ▼).

Press ENTER to access the selected item. Use the ▲ and ▼ arrows to browse the submenus and modify the single parameters. Press ENTER to confirm the value of the selected parameter, press ESC to cancel the operation: In both cases, you return to the initial menu.

Press ESC to return to the main menu from a submenu, and to exit the main menu and return to measurement mode.

Note: Some parameters can be changed only by an user registered as “Administrator” (see the details on page 21).

Language selection

The menu items are in 4 languages: Italian, English, French and Spanish. To select the language, press SETUP, use the ▲ and ▼ arrows to select “Languages / Users / Passwords” >> “User Registration” and select the language using the SETUP key. Press ESC to confirm and return to measurement mode.

The menu items are listed in this order:

1. “INFORMATION / STATUS / HELP”

- 1.1. “*Instrument Info*” shows some information for the instrument: model, types of measurement, firmware version, serial number and calibration date.
- 1.2. “*Instrument Status*” reports the last enabled user, the current type and status of communication interface, the temperature compensation mode and the temperature sensor used for compensation.
- 1.3. “*Short Reference Manual*”. It is a short help showing the instrument main functions.

2. “LANGUAGE / USERS / PASSWORDS”

- 2.1. “*User Registration, current...*” selects the language among Italian, English, French or Spanish and/or the current user type. See the details on page 21.
- 2.2. “*Create / Edit User Password*” allows to create and/or edit the password associated to each registered user: Administrator, User_1, User_2 and User_3. See the details on page 21.
- 2.3. “*User Exit Mode*”: When you turn the instrument on you can get:
 - A) The user of the previous session without requiring a password (“Recall User”),
 - B) Require a user (“Forget User”): in this case, you have to select the user and, if not “Anonymous”, enter the password. This parameter can be modified only by the administrator (see page 21).
- 2.4. “*Instrument Identifier*” allows input of a code to identify the instrument. This will be included in the printouts and in the stored data. Use the *F1= Back* and *F4= Forward* to move the character insertion point, select the single character on the right using the ▲ ▼ ◀ ▶ arrows, confirm using ENTER. Press *F3=Finish* to save and exit. Press ESC to exit without making changes. The instrument identification parameter can be modified only by the administrator (see page 21).

3. “SYSTEM PARAMETERS”

- 3.1. “*Date and Time*” This function manages the instrument date and time setting. Use the ◀ and ▶ arrows to move the cursor, and the ▲ and ▼ arrows to edit the selected value. The SETUP key clears the seconds to synchronize them to the minute: Use the ▲ and ▼ arrows to set the current minute plus one, and as soon as that minute is reached press SETUP. This synchronizes the time to the second. Press ENTER to confirm, ESC to exit without making changes.
- 3.2. “*Memory and Logging Options*” is composed of three sub-functions:
- 3.2.1. “*Sampling Interval*”: Sets the interval in seconds between two loggings. The interval can be set from 0 to 999 seconds. **If the value 0 is set, the logging is disabled.** Press LOG to start the logging, press LOG again to end.
- 3.2.2. “*Storage Mode*”: Selects the instrument memory management mode.
- By setting it to “0” you select the standard mode (normal): When the memory is full, the logging stops; to carry out further recordings, you should download the data, if necessary, and clear them.
 - By setting it to “1” you select the cyclic mode (“endless loop”): When the memory is full, it starts to overwrite the oldest data. Recording is not interrupted.
- The logging mode can be selected or modified only by the administrator (see page 21).
- 3.2.3. “*Print and Storage Mode*”:
- If you select “0”, when using PRINT the current data is sent to the printer but is not saved in the memory.
 - If you select “1”, when using PRINT the current data is sent to the printer and also saved in the memory.
- This parameter can be selected only by the administrator (see page 21).
- 3.3. “*Select the Baud Rate of the serial communication*”. This function allows selection of the frequency used for the serial RS232 communication with the PC. Values from 1200 to 115200 baud. Use the ▲ and ▼ arrows to select the parameter and confirm with ENTER. **The communication between instrument and PC (or serial port printer) only works if the instrument and PC or printer baud rates are the same.** If the USB connection is used this parameter value is automatically set (please see the details on page 49).
- 3.4. “*Electrode Serial Numbers*”. It gives the serial numbers of the SICRAM probes connected to the inputs, and allows to type in the serial numbers of the pH electrodes and probes without SICRAM automatic detection module. These serial numbers are reported in the printouts and stored data.
- The SICRAM pH and conductivity probes report the “service hours”, that is, the number of hours that the probe has been connected to the functioning instrument. This parameter is saved in the SICRAM memory and cannot be modified.
- 3.5. “*System Reset*” It is formed by two sub-functions:
- 3.5.1. “*Partial System Reset*”: The partial reset restores the instrument functioning without modifying the functioning parameter settings such as, Baud Rate, log interval, date and time,... The data in the memory are not cleared. This operation can be carried out only by the administrator (see page 21).
- 3.5.2. “*Complete System Reset*”: The complete system reset restores the instrument to the original factory conditions, restoring all menu parameters. After a complete

reset, the date, time, baud rate, log interval,... must be set again. The data in the memory are not cleared. This operation can be carried out only by the administrator (see page 21).

3.6. “*Bluetooth Parameters*” is displayed by the instruments fitted with the Bluetooth HD22BT module. It is formed by three sub-functions:

3.6.1. “*Disable Bluetooth module*”: Select this item using the ▲ and ▼ arrows and confirm with ENTER to disable the Bluetooth device. This function allows using the COM serial port or the USB port.

3.6.2. “*Bluetooth Connection to a PC*” sets the instrument for connection to a PC fitted with a Bluetooth interface or Bluetooth “HD USB.KL1” module. When exiting the menu, the “BT” symbol blinks up on the left side of display to indicate that the instrument is ready for connection using the DeltaLog11 software. The instrument waits a connection for 10 minutes, then shows an error alternating “BT” and “ERR”. For the details, see the chapter dedicated to PC connection on page 46.

3.6.3. “*Bluetooth Connection to a Printer*” sets the instrument for connection to the S’Print-BT printer fitted with a Bluetooth module. Turn on the printer, select “*Bluetooth Connection to a Printer*” using the ▲ and ▼ arrows, and confirm with ENTER. The instrument searches for all functioning Bluetooth devices and lists them on the display. Use the ▲ and ▼ arrows to select the S’Print-BT printer and confirm with ENTER. When pressing PRINT the data are sent to the Bluetooth printer.

4. “**MEASUREMENT AND pH CALIBRATION OPTIONS**” (for HD2205.2 and HD2256.2)

4.1. “*pH Resolution*”: Selects the number of leading digits for the pH measurement: using the ▲ and ▼ arrows select 7.12 to obtain the pH hundredths or 7.123 to obtain the thousandths. The chosen resolution is applied to the new logged measurements, while the previous choice still applies for the already memorized ones.

4.2. “*pH Buffer Solutions*”: The instruments allows selecting up to 5 buffers for the pH electrode calibration. Press F1, ..., F5 to select BUFFER1, ..., BUFFER5, respectively: Use the ▲ and ▼ arrows to select the value to be assigned to the chosen buffer. You can select one of the 13 buffers in the memory, enter a user defined CUSTOM buffer, or exclude one from the list by selecting NIL. The 13 buffers in the memory are compensated for temperature, but the buffer defined by the user is not compensated for temperature: So the buffer value must be set at the actual solution temperature. As an alternative, the correct value according to temperature can be set in the calibration phase. Please see the chapter dedicated to calibration on page 25.

4.3. “*pH Electrode Calibration History*”: The last eight calibrations on each input channel (BNC or SICRAM) can be stored in the memory. The data are associated to the electrode serial number: for a SICRAM probe, the serial number is read from its memory, otherwise it must be entered in “System Parameters” >> “Electrode Serial Numbers”. The “*Show pH Electrode Calibration History*” submenu displays the following: date, time, operator that carried out the calibration, calibration points (pH, mV and temperature detected). The last 8 calibration information are shown: offset, slope and the symbol indicating the pH electrode efficiency after calibration. Use the ▲ and ▼ arrows to browse the last 8 calibrations. Use the “*Print pH Electrode Calibration History*” function to print the information.

Note for the model HD2205.2: as the pH electrode **non SICRAM** calibration data are saved in the instrument's memory, **it is important to connect the electrode in the same input used during calibration.** The SICRAM pH probe calibration data are read directly in the probe's memory, so these probes do not need to be connected to the same input used for calibration.

- 4.4. “*Electrode Calibration Expiration*”: It is possible to set the pH electrode calibration validity number of days. When the validity period has expired, the “CAL” blinking message appears; the calibration data are still used. The “Expired calibration” message is indicated in the printout. Enter “Number of days” = 0 to disable this feature.

Note: the day is counted at midnight: by entering 1, at midnight of the same day, the calibration is considered expired.

This operation can be carried out only by the administrator (see page 21).

- 4.5. “*Clear Calibration History*”: This function clears the pH electrode calibration information (see “*pH Electrode Calibration History*” above). Press ENTER to erase, ESC to exit without erasing.

This operation can be carried out only by the administrator (see page 21).

5. “CONDUCTIVITY MEASUREMENT OPTIONS” (for HD2206.2 and HD2256.2)

- 5.1. “*ALFA Coefficient*” (α_T): The temperature coefficient α_T is the percentage measurement of the conductivity variation according to temperature and is expressed in %/°C (or %/°F). The admitted values vary from 0.00 to 4.00%/°C. Use the arrows (▲ and ▼) to set the desired coefficient, and confirm with ENTER.

- 5.2. “*Conductivity Reference Temperature*”: It indicates the temperature to which the displayed conductivity value is standardized. The values vary from 0 to 50°C. **Usually the values of 20°C or 25°C are used.** Use the arrows (▲ and ▼) to set the desired value, and confirm with ENTER.

- 5.3. “*TDS Coefficient*”: It represents the χ /TDS conversion factor, that is, the ratio between the measured conductivity value and the total quantity of dissolved solids in the solution, expressed in mg/l (ppm) or g/l (ppt). This conversion factor depends on the nature of the salts present in the solution. In the field of water quality treatment and control, the main component is CaCO₃ (Calcium Carbonate). A value of 0.5 is usually used. In agriculture, for fertilizer water preparation, and in hydroponics, a factor of about 0.7 is used. Using the arrows (▲ and ▼), set the desired value, selecting it in the 0.4...0.8 range, and confirm with ENTER.

- 5.4. “*Conductivity Cell Nominal Value*” Sets the cell constant nominal value of the conductivity probe without SICRAM. In the SICRAM probe, the cell constant nominal value is detected directly by the instrument and cannot be modified. The 0.01, 0.1, 0.5, 0.7, 1.0 and 10 cm⁻¹ are prompted, or a value between 0.01 and 20. **The cell constant must be inserted before starting the probe calibration.** The cell constant change entails resetting the calibration date: The new calibration updates the calibration date.

USER MANAGEMENT

The user must identify himself or herself by entering a user name and password: The registered user name is shown in all performed operations: printing, logging, calibration...

The available users are: *administrator*, *user_1*, *user_2*, *user_3* and *anonymous user*. The different users have different usage levels: The *Administrator* is enabled to use all of the instrument functions and assigns the password to the other users. The three users and the anonymous can access only part of the functions.

Settings

The user management options are stored in the “**LANGUAGE / USERS / PASSWORDS**” menu item.

When the instrument comes out of the factory, the only user stored is the administrator. The password is “00000000”: The “*Create / Edit User Password*” function allows modification of the administrator password.

To enable *user_1*, *user_2* and *user_3*, you must assign a different password (not “00000000”), using the “*Create / Edit User Password*” function.

In order to do that:

1. Select the menu item “*Create / Edit User Password*”.
2. Select the user (e.g. *User_1*) using the ▲ ▼ ◀ ▶ arrows.
3. Type the old password (“00000000” in the new instrument), and confirm with ENTER.
4. Type the new password (not “00000000”), and confirm with ENTER.
5. Select “LANGUAGE / USERS / PASSWORDS” >> “*User Registration, current = Administrator*” using the ▲ ▼ ◀ ▶ arrows, and select the new user to which you have just assigned a password.
6. Type the password, and confirm with ENTER.

Now *User_1* is enabled and can use the instrument: The printed and stored information will show “Operator = *User_1*”.

Note: the passwords beginning with 27 (27000000 to 27999999) are reserved and you cannot use them.

Access modes

If you wish the instrument to request the user selection and relevant password upon turning on, set “*User Exit Mode*” = *Forget User*. When you turn the instrument on you get all the users: Select the user using the ▲ ▼ ◀ ▶ arrows, and type its password. Confirm by pressing ENTER. The anonymous user does not need a password.

If you select “*Recall User*”, the instrument uses the previous user without requiring a password. In this case, use the “*User Registration, current...*” menu item to change the user (see points 5 and 6 above).

Note: the access mode can be modified only by the administrator.

Functions reserved to the administrator

Some functions are reserved to the user registered as "Administrator" (see the details on page 17).

Only the Administrator can:

- Modify the instrument identifier,
- Perform the instrument partial and total reset,
- Set the user exit mode ("*User Exit Mode*"),
- Select the instrument memory management mode ("*Storage Mode*"),
- Set the storage mode when using the PRINT key ("*Print and Storage Mode*"),
- Clear the calibration history ("*Clear Calibration History*"),
- Set the pH calibration interval ("*Electrode Calibration Expiration*"),
- Modify the ID sample value (ID key),
- Clear the memory (see the paragraph on page 50).

pH measurement

The HD2205.2 and HD2256.2 instruments work with pH/temperature probes complete with SICRAM module, pH measurement electrodes, redox potential measurement electrodes (ORP), and specific ion electrodes. The pH measurement is generally accompanied by the temperature measurement. The SICRAM combined pH/temperature probes are fitted with Pt100 temperature sensor: The instruments measure also the temperature using probes fitted with 4 wire Pt100, or 2 wire Pt1000 sensors, or using probes complete with SICRAM module. The temperature is used for the automatic compensation of the Nernst coefficient with the pH electrode.

If a temperature only probe is connected (connector ⑤), it has priority on the temperature supplied by any combined probe: Please see the chapter dedicated to temperature measurement on page 36.

Probes with SICRAM and without SICRAM

The SICRAM pH probe is formed by a pH electrode, a Pt100 temperature sensor and an electronic module. The module has a memory circuit that enables the instrument to recognize the type of probe connected. It stores also the serial number, the factory calibration of the Pt100 sensor, the manufacturing date and the parameters of the last two pH calibration performed by the user.

The instrument stores the last eight pH calibrations performed by the user: The last two calibration are stored also in the probe's SICRAM memory. Upon power on, the instrument reads the two calibrations in the probe and, if the probe was calibrated on the same instrument, they are added to the ones already stored in the instrument in order to make up the history calibration of the SICRAM pH probe. If the SICRAM pH probe is connected to a different instrument, only the parameters in the probe memory will make up the calibration history.

If a SICRAM pH probe is connected to the instrument, the relevant BNC direct input is disabled: The SICRAM pH probe has priority on the electrode connected directly to the BNC input.

Module pH SICRAM KP47

The KP47 module is a SICRAM type interface for pH electrodes with BNC connector. By using this module you can add all of the advantages of a SICRAM probe to a pH electrode: For example, you can move the module linked to the electrode from an input to another (for the HD2205.2) or from an instrument pH SICRAM input to a second instrument, without performing a new calibration.

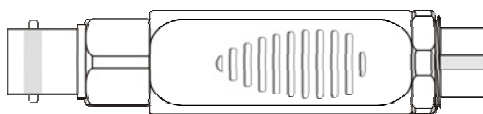

The module is automatically recognized by the instrument when you turn it on, and the serial number and parameters described above are read.

You just need to connect the electrode to the module female BNC connector, connect the module to the pH SICRAM inputs (③ and ④), and turn on the instrument. Perform a first calibration on two or more points. One must be in the neutral band (e.g. 6.86pH). The module is now ready for use.

Of course, once the calibration is performed, the electrode linked to the module should not be changed: As the electrode calibration information are saved in the module, this will generate measurement errors. When you replace the electrode you should do a new calibration.

The electrode for pH measurement

The electrode for pH measurement, generally in glass, generates an electrical signal proportional to the pH according to Nernst law. Of this signal the following aspects are considered:

Zero point: The pH where the electrode generates a potential of 0 mV. In most electrodes, this value is found at about 7 pH.

Offset or Asymmetry Potential: mV generated by an electrode when immersed in a buffer solution at 7pH. Generally oscillates between ± 20 mV.

Slope: Response of the electrode expressed in mV per pH units. The theoretical electrode slope at 25°C is 59.16 mV/pH. When the electrode is new the slope is close to the theoretical value.

Sensitivity: It is the electrode's slope expression in relative terms. It is obtained by dividing the actual value of the slope by the theoretical value, and is expressed as a %. The asymmetry potential and the slope vary in time with the use of the electrode, which necessitates regular calibration.

The pH electrodes must be calibrated using the standard solutions (see the calibration chapter below). The ORP and specific ion electrodes do not need calibration. **The standard redox solutions are only used to check the quality of a redox electrode.**

User calibration of the temperature sensor is not required: The sensor is calibrated in the factory and the Callendar Van Dusen parameters are recorded in the SICRAM module.

The probes are detected during turn on, and this cannot be performed when the instrument is already on, therefore if a probe is connected and the instrument is on, it is necessary to turn it off and on.

Automatic or manual pH compensation

The pH measurement is influenced by the measured solution temperature.

The electrode slope varies according to the temperature in a known mode according to Nernst law: e.g., a 1pH variation, that at 25°C means 59.16mV, at 100°C means 74.04mV.

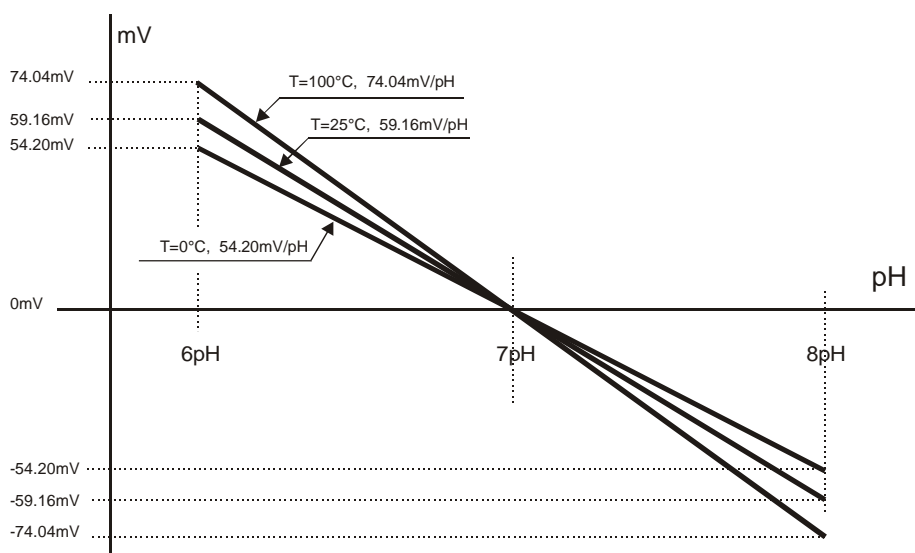

When a temperature probe is present (temperature only probe, combined pH/temperature probe or conductivity/temperature probe), the instrument automatically applies the ATC (Automatic Temperature Compensation) function.

In absence of the temperature probe or sensor, the lower display shows the **MTC** (Manual Compensation Temperature). If the correct value is not entered manually, the extent of the error committed in pH measurement is proportional to temperature and measured liquid pH value itself.

In **MTC** mode, in order to manually change the compensation temperature press F5=°C/°F once: The indicated temperature value starts blinking. Select the desired temperature value by using the ▲ and ▼ arrows, and confirm with ENTER. The display stops blinking, and the temperature displayed is used for compensation.

During manual compensation, in order to change the unit of measurement between °C and °F, it is necessary to press the °C/°F key twice.

pH electrode calibration

The electrode calibration is used to compensate the asymmetry potential and slope departures to which the electrode is subject with time.

The calibration frequency depends on the accuracy desired by the user and on the effects that the measured sample has on the electrode. Generally, we recommend daily calibration, but it is the user's responsibility from personal experience, to establish the most appropriate frequency.

The calibration may be carried out using one or more points (up to 5): when using 1 point, the electrode offset is corrected, with 2 points the offset and the gain is corrected.

The instrument has a memory of 13 buffers with relevant temperature compensation tables (ATC) plus a "CUSTOM" buffer, not compensated for temperature. The five buffers can be selected by using the **BUFFER_1, ..., BUFFER_5** menu items. Usually two for the acid, one for the neutral, and two for the alkaline band will be selected:

@25°C

BUFR_1 (NEUTRAL)	6,860	6,865	7,000	7,413	7,648
BUFR_2 (ACID)	1,679	2,000	4,000	4,008	4,010
BUFR_3 (ALKALINE)	9,180	9,210	10,010		

If electrode calibration was not carried out on the instrument, or the last calibration failed, the display blinks the **CAL** message.

Calibration procedure

1. Select the buffers in the "Measurement and pH Calibration Options" >> "pH Standard Solutions" menu item (please see the menu description on page 17). This operation must be performed only the first time or when the normal calibration buffers are changed.
2. Insert the SICRAM pH/temperature probe or the electrode and temperature probe in the solution of the selected calibration buffer. If no temperature probe is available, use a thermometer and enter the value manually as indicated in the paragraph "Automatic or Manual pH Compensation".
3. The electrode calibration mode is started by pressing **CAL**.
4. Select the pH input connected to the electrode being calibrated.
5. Among the three prepared buffers, the instrument automatically detects the closest to the pH value being read, and shows the nominal value at 25°C on the right with a blinking arrow.

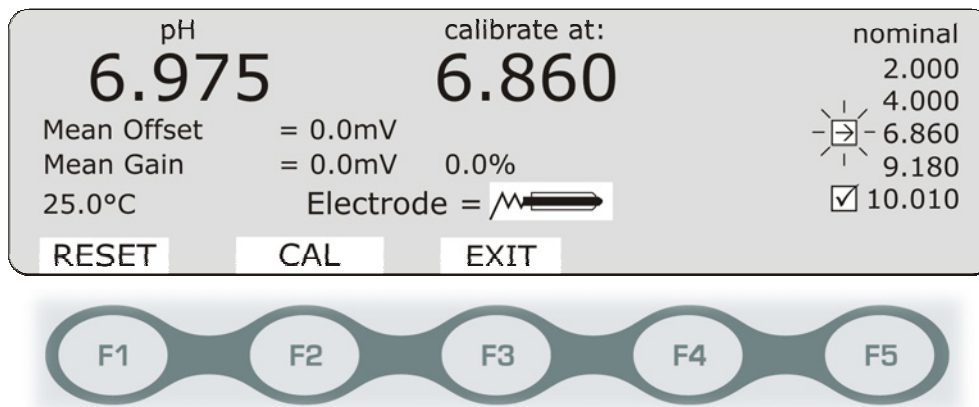

The display shows on the left the current pH measurement value according to current calibration. The buffer value compensated for temperature is displayed in the center.

The detected and temperature compensated buffer value, shown in the center, can be modified using the arrows \blacktriangledown and \blacktriangle .

6. To proceed with the calibration press **F2 = CAL**. The offset and gain calibration and the electrode efficiency are displayed.
The blinking arrow changes to to indicate that the current value has been accepted. The blinking means the instrument is still in calibration mode. By pressing F2 = CAL again, it is possible to repeat the calibration from the last point to obtain a finer calibration.
7. Extract the electrode from the buffer, wash it, clean it carefully, and insert it in the following buffer.
8. The instrument shows the new buffer value with the blinking arrow. **The previous calibration point is captured permanently:** The blinking , becomes still.
9. Continue with other calibration points, by repeating the steps from point 6.
10. To end the electrode calibration, press **F3 = EXIT**.

NOTES:

- **By accessing the pH calibration, the previous calibration information are transferred in the “pH Electrode Calibration History”. The current offset and slope values are set to nominal values: The offset = 0mV, the gain varies according to the measured temperature (59.16mV/pH at 25°C).**
You should perform a new calibration.
- If an error is made during calibration, you can press F1 = RESET to restart with a new calibration.
- The instrument is provided with a measurement stability control system: Until the reading is not sufficiently stable, the F2 = CAL key is disabled. Instead, the WAIT message is displayed.
- When choosing the standard buffer (see the MENU), you can disable one by selecting **NIL**. In this case, the buffer is excluded from the sequence, and won't be proposed during calibration.
- If the buffer value is rejected because it is considered to be excessively corrupted, the “*Buffer value out of limits!*” message will appear. The instrument waits for a valid buffer. If it is not available, press F1=RESET to restore the initial calibration and exit using F3=EXIT. Repeat the calibration as soon as possible.
- During calibration, the instrument evaluates the electrode efficiency: If the correction is excessive, the electrode symbol is replaced by “ERROR”. If you confirm the calibration anyway, the electrode symbol blinks during measurement to remind you that you should replace it as soon as possible.

Temperature characteristics of Delta OHM standard solutions

The 13 standard buffers reported in the table on page 25 are memorized in the instruments with relevant variations according to temperature: The characteristics of the three Delta Ohm standard buffers at 6.86pH, 4.01pH and 9.18pH (@25°C) are reported below.

6.86 pH @ 25°C

°C	pH	°C	pH
0	6.98	50	6.83
5	6.95	55	6.83
10	6.92	60	6.84
15	6.90	65	6.85
20	6.88	70	6.85
25	6.86	75	6.86
30	6.85	80	6.86
35	6.84	85	6.87
40	6.84	90	6.88
45	6.83	95	6.89

4.01 pH @ 25°C

°C	pH	°C	pH
0	4.01	50	4.06
5	4.00	55	4.07
10	4.00	60	4.09
15	4.00	65	4.10
20	4.00	70	4.13
25	4.01	75	4.14
30	4.01	80	4.16
35	4.02	85	4.18
40	4.03	90	4.20
45	4.05	95	4.23

9.18 pH @ 25°C

°C	pH	°C	pH
0	9.46	50	9.01
5	9.39	55	8.99
10	9.33	60	8.97
15	9.28	65	8.94
20	9.22	70	8.92
25	9.18	75	8.90
30	9.14	80	8.88
35	9.10	85	8.86
40	9.07	90	8.85
45	9.04	95	8.83

Conductivity measurement

The HD2206.2 and HD2256.2 work with direct conductivity/temperature probes (input ⑧), direct 4-electrode and 2-electrode only conductivity probes (input ⑧), or combined conductivity/temperature probes with SICRAM (input ⑦). The 4 wire Pt100, 2 wire Pt1000 sensors may be used for measuring temperature, which is used for the automatic compensation of the conductivity.

If a temperature only probe is connected (connector ⑤), the measured temperature becomes the reference value for the measurement system, and has priority on the one supplied by the combined conductivity probe.

Probes with SICRAM and without SICRAM

The combined conductivity probe with SICRAM is fitted with a Pt100 temperature sensor and an electronic module. The module has a memory circuit that enables the instrument to recognize the type of probe connected. It stores also the serial number, the factory calibration of the Pt100 sensor, the manufacturing date and the last calibration performed by the user.

The combined conductivity probe with SICRAM is connected to input ⑦, the direct probe without SICRAM is connected to input ⑧: if the inputs are exchanged, the instrument does not measure and displays 0.0 $\mu\text{S}/\text{cm}$. If you connect simultaneously two conductivity probes (one with SICRAM and one without SICRAM) to the respective inputs, the displayed measurement is not correct.

The conductivity probes with SICRAM use the cell constant stored in their memory, the probes without SICRAM use the cell constant stored in the instrument during calibration.

A new calibration updates the cell constant. If the probe is fitted with a SICRAM module, the new cell constant is saved in the probe's memory. If the probe is not fitted with a SICRAM module, the cell constant is saved in the instrument's memory.

The instrument stores the nominal cell constant entered manually in the menu. If you perform a calibration using a probe without SICRAM, the instrument updates the constant in the memory with the new one resulting from the calibration of the new probe without SICRAM.

If you connect and disconnect a probe with SICRAM, and later you connect a probe without SICRAM, the instrument reloads the cell constant of the last calibration performed using the probe without SICRAM. If the conductivity probe is the one used for the last calibration without SICRAM, the cell constant proposed is correct. If the conductivity probe is different, to obtain a correct measurement you have to manually set the cell constant and perform a new calibration.

For the direct probes (non SICRAM), the cell constant nominal value must be entered in the “Conductivity Measurement Options” >> “Conductivity Cell Nominal Value” menu item. You cannot modify the cell constant value of a probe with SICRAM directly from the menu.

The instrument obtains the following from the measurement of conductivity:

- the liquid resistivity measurement (Ω , $\text{k}\Omega$, $\text{M}\Omega$),
- the concentration of total dissolved solids (TDS) according to the χ/TDS conversion factor, which can be modified using the menu,
- the salinity (NaCl quantity in the solution, expressed in g/l).

By repeatedly pressing “F2 = cond.” you can select the quantity.

The conductivity probes must be periodically calibrated. To facilitate this operation, four standard calibration solutions are automatically recognized by the instrument:

- 0.001 Molar KCl solution (147 μ S/cm @25°C),
- 0.01 Molar KCl solution (1413 μ S/cm @25°C),
- 0.1 Molar KCl solution (12880 μ S/cm @25°C),
- 1 Molar KCl solution (111800 μ S/cm @25°C),

User calibration of the temperature sensors is not required. The 4 wire and 2 wire probes with direct input **are checked for conformity with class A tolerance** according to norm IEC751 - BS1904 - DIN43760.

The probes are detected during turn on, and this cannot be performed when the instrument is already on, therefore if a probe is connected and the instrument is on, it is necessary to turn it off and on.

Standard SP06T probe

The 4-electrode conductivity/temperature combined probe, code SP06T, is delimited by a bell in Pocan.

A positioning key, present in the probe's end part, orients the bell correctly when the probe is introduced. For cleaning, simply pull the bell along the probe's axis **without rotating it. It is not possible to perform measurements without this bell.**

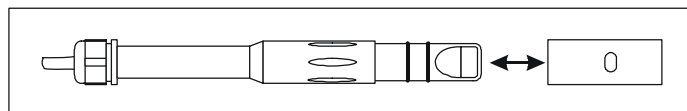

The probe is recommended for non-heavy general use. The temperature measuring range is 0°C...+90°C.

4-electrode or 2-electrode probes

The HD2206.2 and l'HD2256.2 use 4-electrode or 2-electrode probes for conductivity measurement. The selection of the type of probe is automatic.

The 4-electrode probes are preferred to measure high conductivity solutions, either over an extended range or in presence of pollutants. The 2-electrode probes operate in a shorter measurement range but with an accuracy comparable with the 4-electrode probes.

The probes can be in glass or plastic: The first can work in presence of aggressive pollutants, the latter are more resistant to collisions, and so more suitable for industrial use.

Probes with temperature sensor

The conductivity probes fitted with built-in Pt100 temperature sensor, measure conductivity and temperature at the same time: This allows automatic correction of the conductivity (**ATC**) according to the measured temperature. Alternatively, you can measure the temperature using a Pt100 or Pt1000 probe connected to the input ⑤ reserved to temperature probes: If this probe is present, the temperature of the combined probes is not used.

In absence of temperature sensors, the lower display shows the **MTC** (Manual Compensation Temperature) symbol. If the correct value is not entered manually, the extent of the error committed in conductivity measurement is proportional to temperature and α_T coefficient.

Choosing the cell constant

The cell constant K is a piece of information which characterizes the cell. It depends on its geometry and is expressed in cm^{-1} . There is no cell capable of measuring the entire conductivity scale accurately enough. Consequently, cells with different constants are used allowing good accuracy on different scales. The cell with constant $K = 1\text{cm}^{-1}$ allows measurements from low conductivity up to relatively high conductivity.

The theoretical measurement cell is made of two 1cm^2 metallic plates separated one from the other by 1cm . This type of cell has a cell constant K_{cell} of 1cm^{-1} . In essence, the number, form, material and dimensions of the plates in the cell are different from model to model, from manufacturer to manufacturer.

The low constant K probes are preferably used for low conductivity values, the high constant ones for high values.

The indicative measurement range is reported in the following diagram:

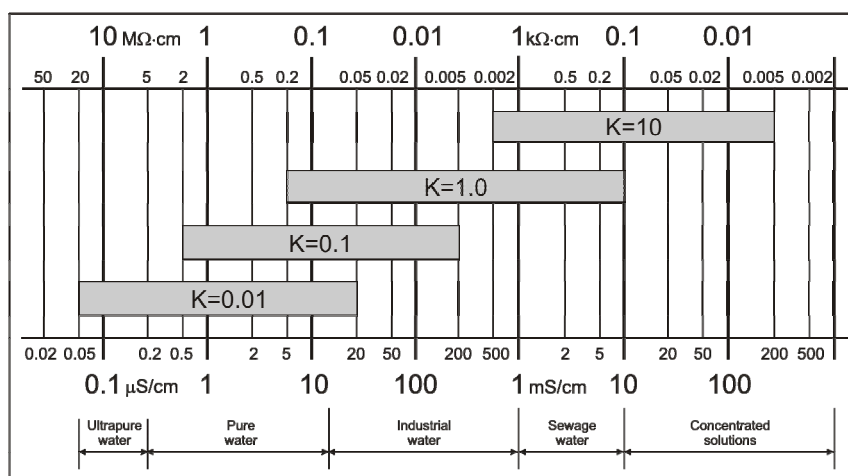

Automatic or manual temperature compensation for conductivity measurement

The conductivity measurement generally refers to a standard temperature, called **reference temperature**, that is, the instrument proposes the conductivity you would get at the reference temperature. This temperature can be chosen within the range $0\text{...}50^\circ\text{C}$ in the “*Conductivity Reference Temperature*” menu item (**usually the values of 20°C or 25°C are used**).

The conductivity variation per each grade of temperature variation is a characteristic of the solution and is indicated by the term “**temperature coefficient α_T** ”: admissible values from 0.00 to $4.00\%/^\circ\text{C}$, **default value $2.00\%/^\circ\text{C}$** .

When a temperature sensor is present, the instrument automatically applies the temperature compensation function, and proposes the measurement using the reference temperature according to the coefficient α_T on the display.

In absence of a temperature probe or sensor, the display shows the **MTC** symbol under the measured temperature, to indicate the compensation temperature has been set manually.

The **MTC** (Manual Compensation Temperature) symbol is included in the printouts; if the temperature probe is present, the **ATC** (Automatic Temperature Compensation) symbol is reported.

In MTC mode, in order to manually change the compensation temperature press $F5=^\circ\text{C}/^\circ\text{F}$ once: The indicated temperature value starts blinking. Select the desired temperature value by using the \blacktriangle and \blacktriangledown arrows, and confirm with ENTER. The display stops blinking, and the temperature displayed is used for compensation.

During manual compensation, to change the unit of measurement between $^\circ\text{C}$ and $^\circ\text{F}$, it is necessary to press the “ $F5=^\circ\text{C}/^\circ\text{F}$ ” key **twice**.

Resistivity, TDS and salinity measurements

The HD2206.2 and HD2256.2 measure electric conductivity and temperature of a solution, and calculates resistivity, salinity and TDS. By repeatedly pressing “F1 = cond.” (HD2206.2) and “F2 = cond.” (HD2256.2) you can select the measurement.

The *resistivity* is defined as the reciprocal of conductivity. The measurement is expressed in $\Omega\cdot\text{cm}$ or one of the derived units ($\text{k}\Omega\cdot\text{cm}$, $\text{M}\Omega\cdot\text{cm}$ or $\text{G}\Omega\cdot\text{cm}$). It is generally used to measure pure and ultra pure water.

The *salinity* is calculated using a more complex calculation: It is based on the assumption that the measured conductivity is entirely and only due to the sodium chloride (NaCl) dissolved in the water. It is expressed in g/l or mg/l.

The *TDS* (Total Dissolved Solids) is the measurement of the total concentration of ion species in the solution. It is calculated from by multiplying the conductivity measurement by a factor called “*TDS Coefficient*”, set in the menu from 0.4 to 0.8 (MENU >> “CONDUCTIVITY MEASUREMENT OPTIONS” >> “*TDS Coefficient*”). The measurement of total dissolved solids is expressed in g/l or mg/l.

Calibration of conductivity

The probe calibration can be carried out on one to four points, using the standard solutions automatically detected by the instrument (automatic calibration) or other solutions with known temperature characteristics (manual calibration).

Technical note on the instrument functioning

The instrument uses four different automatically selected measurement scales: When the cell constant is equal to 1, the four standard calibration solutions are associated to a different measurement scale. The calibration solution at $147\mu\text{S}/\text{cm}$ refers to the measurement scale 0, the solution at $1413\mu\text{S}/\text{cm}$ to the measurement scale 1, and so on. When the calibration point is confirmed using the CAL key (see the details in the next paragraph), the display indicates the calibrated scale (range) with the symbol.

If the calibration was performed on multiple solutions, make sure that the symbol is displayed near a non yet calibrated range: It is useless to calibrate the same range twice.

This warning is valid only if the cell constant is different from 1, and/or the solutions used are not standard.

Automatic calibration of conductivity using memorized standard solutions

The instrument can recognize four standard calibration solutions:

- 0.001 Molar KCl solution ($147\mu\text{S}/\text{cm}$ @25°C),
- 0.01 Molar KCl solution ($1413\mu\text{S}/\text{cm}$ @25°C),
- 0.1 Molar KCl solution ($12880\mu\text{S}/\text{cm}$ @25°C),
- 1 Molar KCl solution ($111800\mu\text{S}/\text{cm}$ @25°C),

By using one of these solutions, the calibration is automatic; the calibration can be carried out on multiple points to increase accuracy.

The manual calibration is possible with a different conductivity solution from that used in the automatic calibration.

The solution temperature for the calibration must be between 15°C and 35°C: If the solution is under 15°C, or over 35°C, the instrument rejects the calibration and displays “NON ADMISSIBLE CAL”.

1. Turn the instrument on with the **ON/OFF** key.
2. If the probe is direct, without SICRAM, set the cell constant nominal value in the menu for the probe being calibrated (point 5.3 on page 20).
3. Set the α_T temperature coefficient in the menu (point 5 on page 20): For Delta OHM calibration solutions, enter 2.00%/°C.
4. Set the reference temperature in the menu (20°C or 25°C) (point 5.1 on page 20):
5. Dip the conductivity meter cell in the calibration solution until the electrodes are covered with liquid.
6. Stir the probe lightly to remove any possible air inside the measurement cell.
7. If the conductivity probe is not fitted with a temperature sensor, connect a temperature probe to the connector ⑤, and immerse it together with the conductivity probe. Alternatively, press °C/°F, set the standard solution temperature value manually by using the ▼ and ▲ arrows (manual setting of temperature). Confirm by pressing ENTER.
8. Press **CAL**, followed by “**F2 = cond.**”
9. **The cell constant Kcell is set to the nominal value input in the menu if the probe is direct without SICRAM, or to the value read in the memory of the SICRAM type probe.**
10. Among the standard buffers, the instrument automatically detects the closest to the conductivity value being read, and shows the nominal value at 25°C on the right with a blinking arrow.

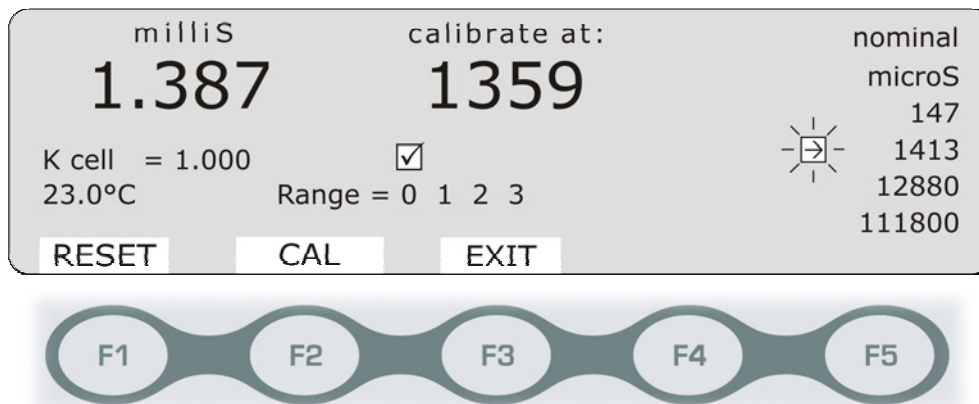

The displays shows on the left the conductivity measurement value based on the cell constant specified before. The recognized standard calibration solution value is displayed in the center. Both values refer to the solution actual temperature, that is, *not compensated*. Also the current cell constant Kcell, the solution temperature and the 4 measurement ranges (Range = 0 1 2 3) are reported.

If the measurement was TDS, resistivity or salinity, by pressing CAL the instrument goes automatically into conductivity calibration mode.

11. The detected buffer value, shown in the center, can be modified using the arrows ▲ and ▼.
12. To proceed with the calibration press **F2 = CAL**. The cell constant actual value is displayed. The ☑ symbol is displayed over the number identifying the calibrated range. The instrument is still in calibration mode: By pressing **F2 = CAL** again, it is possible to repeat the current calibration point to obtain a finer calibration.

13. To end the calibration and return to measurement, press **F3 = EXIT** (step 17), or continue the calibration for the next point.
14. Extract the probe from the calibration solution, wash it, clean it carefully, and insert it in the following solution.
15. The instrument proposes the value of the new solution with the blinking arrow. **The previous point is captured permanently.**
16. Continue the calibration by repeating the steps from point 9.
17. To end the calibration press **F3 = EXIT**.
18. Rinse the probe with water. If you are going to perform low conductivity measurements, we recommend rinsing the probe using distilled or bidistilled water.

The instrument is calibrated and ready for use.

If the probe is not fitted with a SICRAM module, the calibration updates the cell constant and saves it in the instrument's memory. If the probe is fitted with a SICRAM module, the cell constant is saved in the probe's memory.

Note: When calibrating multiple points, it is recommended to start from lower values toward higher values, not vice versa.

Manual calibration of conductivity using not-memorized standard solutions

Manual calibration is possible at any calibration solution and temperature if it is within the instrument measurement limits and provided that you know the solution's conductivity at the calibration temperature.

The solution temperature must be between 15°C and 35°C: If the solution is under 15°C, or over 35°C, the instrument rejects the calibration and displays “NON ADMISSIBLE CAL”.

Proceed as follows:

1. Turn the instrument on with the **ON/OFF** key.
2. If the probe is without SICRAM, set the cell constant nominal value in the menu for the probe (point 5.4 on page 20).
3. Set the α_T temperature coefficient to 0.0 (point 5.1 on page 20).
4. Dip the conductivity meter cell into a known conductivity solution. The electrodes must be immersed in the liquid.
5. Stir the probe lightly to remove any possible air inside the measurement cell.
6. Take note of the solution temperature: If the conductivity probe is not fitted with a temperature sensor, connect a temperature probe to the connector ⑤, and immerse it together with the conductivity probe. According to the temperature detected, determine the calibration solution conductivity using the table specifying the conductivity according to temperature.
7. Press **CAL**, followed by “**F2 = cond.**”
8. **The cell constant Kcell is set to the nominal value input in the menu if the probe is without SICRAM, or to the value read in the memory of the probe with SICRAM.**
9. The instrument measures the conductivity value based on the cell constant specified before and displays it on the left column.

If the read value is sufficiently close to the theoretical one, the central column reports the actual value, at the measured temperature, of one of the four standard solutions: an arrow blinks near the detected standard solution, displayed in the list on the right. Continue the calibration from point 10 of the previous chapter “*Automatic calibration of conductivity using memorized standard solutions*”.

The central column reports the same value in the left column, if the calibration solution value is too far from the four standard solutions (147 μ S/cm, 1413 μ S/cm,...). Continue the calibration according to the following point:

10. Using the arrows (\blacktriangle and \blacktriangledown) set the conductivity value determined in point 6, and confirm with “**F2 = CAL**”. The cell constant correction is displayed.
The symbol is displayed over the number identifying the calibrated range. The instrument is still in calibration mode: By pressing “**F2 = CAL**” again, it is possible to repeat the current calibration point to obtain a finer calibration.
11. To end the calibration and return to measurement, press **F3 = EXIT** (step 17), or continue the calibration for the next point.
12. **If the next calibration solution is one of the standard solutions automatically detected by the instrument**, open the menu and re-enter the temperature coefficient as it was before the calibration. Extract the probe from the calibration solution, wash it, clean it carefully, and insert it in the following solution. Continue the calibration from point 10 of the previous chapter “*Automatic calibration of conductivity using memorized standard solutions*”.
13. **If the next calibration solution is NOT one of the standard solutions automatically detected by the instrument**, extract the probe from the calibration solution, wash it, clean it carefully, and insert it in the following solution.
14. The instrument proposes the value of the new solution: **The previous point is captured permanently:**
15. Continue by repeating the steps from point 9.
16. To end the calibration press “**F3 = EXIT**”.
17. Open again the menu, and re-enter the temperature coefficient as it was before the calibration.
18. Rinse the probe with water. If you are going to perform low conductivity measurements, we recommend rinsing the probe using distilled or bidistilled water.

The instrument is now calibrated and ready for use.

If the probe is not fitted with a SICRAM module, the calibration updates the cell constant and saves it in the instrument’s memory. If the probe is fitted with a SICRAM module, the cell constant is saved in the probe’s memory.

NOTES:

- **By accessing the calibration, the cell constant Kcell is set to the nominal value input in the menu if the probe is without SICRAM, or to the value read in the memory of the probe with SICRAM.**
- Upon confirming the calibration by using “**F2 = CAL**”, the instrument checks that the correction to the cell constant does not exceed the $\pm 10\%$ limits. If the calibration is rejected because it exceeds the $\pm 10\%$ limit, the “**CAL ERROR**” message will appear, followed by a long beep. The instrument remains in calibration mode and maintains the nominal cell constant entered manually in the menu or read from the SICRAM memory: If you leave the calibration by pressing EXIT, the instrument will use the cell constant K nominal value.

- If you get the “**CAL ERROR**” message during calibration, check that the input cell constant is correct.
- The most frequent causes of error are due to the probe malfunctioning due to deposits, dirt or to the standard solutions deterioration (bad preservation conditions, alteration due to pollution with other solutions, ...). Please see the chapter dedicated to troubleshooting on page 40.

Table of standard solutions at 147 μ S/cm, 1413 μ S/cm, 12880 μ S/cm and 111800 μ S/cm

The table reports the standard solutions automatically detected by the instrument according to temperature.

$^{\circ}$ C	μ S/cm	μ S/cm	mS/cm	mS/cm
15.0	121	1147	10.48	92.5
16.0	124	1173	10.72	94.4
17.0	126	1199	10.95	96.3
18.0	128	1225	11.19	98.2
19.0	130	1251	11.43	100.1
20.0	133	1278	11.67	102.1
21.0	136	1305	11.91	104.0
22.0	138	1332	12.15	105.9
23.0	141	1359	12.39	107.9
24.0	144	1386	12.64	109.8
25.0	147	1413	12.88	111.8

$^{\circ}$ C	μ S/cm	μ S/cm	mS/cm	mS/cm
25.0	147	1413	12.88	111.8
26.0	150	1440	13.13	113.8
27.0	153	1467	13.37	115.7
28.0	157	1494	13.62	117.7
29.0	161	1521	13.87	119.8
30.0	164	1548	14.12	121.9
31.0	168	1581	14.37	124.0
32.0	172	1609	14.62	126.1
33.0	177	1638	14.88	128.3
34.0	181	1667	15.13	130.5
35.0	186	1696	15.39	132.8

TEMPERATURE MEASUREMENT

The instrument accepts Platinum temperature probes with resistances of 100 Ω or 1000 Ω at 0°C, with SICRAM module or direct sensor, in the dedicated input ⑤ reserved to temperature probes. The Pt100 are connected to 4 wires, the Pt1000 to 2 wires. The instrument, according to the version, can also measure the temperature using the combined pH/temperature, conductivity/temperature probes.

The temperature sensor excitation current was chosen in order to minimize the sensor self-heating effects.

All probes with SICRAM module are calibrated in the factory. The 4 wire and 2 wire probes with direct input **are checked for conformity with class A tolerance** according to norm IEC751 - BS1904 - DIN43760.

The probes are detected during turn on: if a probe is connected and the instrument is on, it is necessary to turn it off and on.

The °C or °F unit of measurement can be chosen for display, printing, and logging using the **F5 = °C/°F** key.

The displayed temperature is used for pH, conductivity (according to the models) compensation. If no temperature or combined temperature probes are present, the manual temperature is displayed: The **MTC** message is displayed. If at least one temperature probe is connected (temperature only probe or combined probe), the message becomes **ATC**. The measured temperature is used to compensate the pH, conductivity measurements.

In case of multiple temperature sensors connected to the instrument (e.g. Pt100 probe, pH/temperature probe with SICRAM, combined conductivity probe), the **reference** temperature to compensate **all** measurements, is chosen according to the following principle: **The temperature only probe ⑤ has priority on the temperature supplied by combined probes. If the temperature only probe ⑤ is not present, priority is given according to the connector sequence from left to right:** e.g. the first pH SICRAM input ③ has priority on the conductivity SICRAM input ⑦, and on the conductivity direct input ⑧.

If you disconnect the reference temperature probe (temperature only probe or combined probe), the instrument switches from ATC to MTC mode, unless other probes are connected. The temperature used for compensation is the one manually set using the “F5 = °C/°F” function (see the description on page 12).

How to measure

The temperature measurement by **immersion** is carried out by inserting the probe in the liquid for at least 60mm; the sensor is housed in the end part of the probe.

In the temperature measurement by **penetration** the probe tip must be inserted to a depth of at least 60mm, the sensor is housed in the end part of the probe. When measuring the temperature on frozen blocks it is convenient to use a tool to bore a cavity in which to insert the tip probe.

In order to perform a correct **contact** measurement, the measurement surface must be even and smooth, and the probe must be perpendicular to the measurement plane.

So as to obtain the correct measurement, the insertion of a drop of oil or heat-conductive paste is useful (do not use water or solvents). This method also improves the response time.

Instructions to connect the TP47 connector for Pt100 probes or Pt1000

All Delta Ohm probes are provided with a connector. The HD2205.2, HD2206.2 and HD2256.2 instruments also work with direct 4 wire Pt100, and 2 wire Pt1000 probes manufactured by other producers: For the instrument connection is prescribed the TP47 connector to which the probe's wires should be welded.

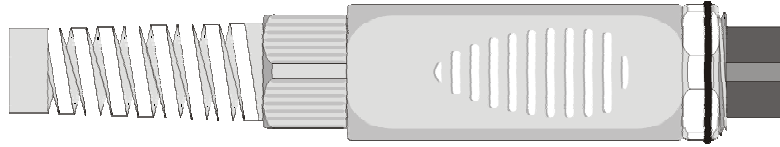

The instructions to connect the Platinum probe to the TP47 module are provided below.

The module is supplied complete with fairlead and gasket for 5mm maximum diameter cables.

Do the following to open the module and connect a probe:

Unscrew the fairlead and extract the gasket, remove the label using a cutter, unscrew the ring on the opposite side as illustrated in the figure:

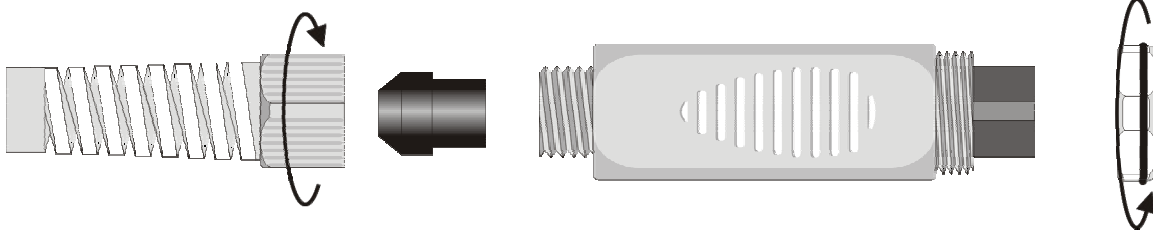

Open the two module shells: The printed circuit to which the probe must be connected is housed inside. On the left there are the 1...4 points on which the sensor wires must be welded. The JP1...JP4 jumpers are in the center of the card. These must be closed with a tin bead for some type of sensors:

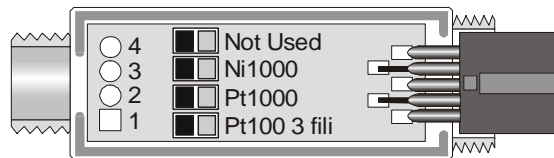

Before welding, pass the probe cable through the fairlead and gasket.

Weld the wires as shown in the table:

Sensor	Card connection	Jumper to close
Pt100 4 wires		None

Sensor	Card connection	Jumper to close
Pt1000 2 wires		JP2

Ensure the welds are clean and perfect. Once the welding operation is complete, close the two shells, insert the gasket in the module, and screw the fairlead. At the other end of the module, enter the ring with the O-ring as indicated in the picture.

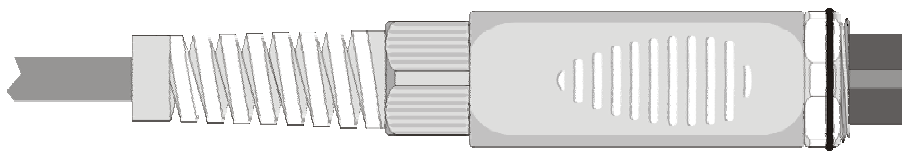

Make sure the cable is not twisted while you are screwing the fairlead. Now the probe is ready.

Direct connection of the 4 wire Pt100 sensor to a DIN45326 connector

Sensor	Direct soldering to the connector
Pt100 4 wires	<p>View of the soldering side of the flying female connector</p>

The **4 wire Pt100** sensor can be welded directly on the DIN45326 female connector's pins, without using the TP47 card. The 4 wires of the Pt100 are welded as outlined in the scheme on the side.

The Pt100 probe is detected during turn on: insert the probe when the instrument is off, and switch it on.

This connection does not guarantee the IP66 protection degree.

WARNINGS AND OPERATING INSTRUCTIONS ON THE TEMPERATURE SENSORS

1. Do not expose the probes to gases or liquids that could corrode the material of the sensor or the probe itself. Clean the probe carefully after each measurement.
2. Do not bend the probe connectors or force them upward or downward.
3. If the connector is fitted with a seal rubber ring (o-ring), make sure it is inserted all the way.
4. Do not bend, deform or drop the probes, as this could cause irreparable damage.
5. Always select the most suitable probe for your application.
6. Do not use the temperature probes in presence of corrosive gases or liquids. The sensor container is made of AISI 316 stainless steel, while the contact probe container is made from AISI 316 stainless steel plus silver. Avoid contact between the probe surface and any sticky surface or substance that could corrode or damage it.
7. Avoid blows or thermal shocks to Platinum temperature probes as this could cause irreparable damage.
8. To obtain reliable measurements, temperature variations that are too rapid must be avoided.
9. Temperature probes for surface measurements (contact probes) must be held perpendicular against the surface. Apply oil or heat-conductive paste between the surface and the probe in order to improve contact and reduce reading time. Whatever you do, do not use water or solvent for this purpose. A contact measurement is always very hard to perform. It has high levels of uncertainty and depends on the ability of the operator.
10. Temperature measurements on non-metal surfaces usually require a great deal of time due to the low heat conductivity of non-metal materials.
11. Probes are not insulated from their external casing; be very careful not to come into contact with live parts (above 48V). This could be extremely dangerous for the instrument as well as for the operator, who could be electrocuted.

12. Avoid taking measurements in presence of high frequency sources, microwave ovens or large magnetic fields; results may not be very reliable.
13. Clean the probe carefully after use.
14. The instrument is water resistant and IP66, but should not be immersed in water. Close the free connectors using caps. The probe connectors must be fitted with sealing gaskets.

INSTRUMENT STORAGE

Instrument storage conditions:

- Temperature: -25...+65°C.
- Humidity: less than 90% RH without condensation.
- During storage avoid locations where:
 - humidity is high,
 - the instrument may be exposed to direct sunlight,
 - the instrument may be exposed to a source of high temperature;
 - the instrument may be exposed to strong vibrations;
 - the instrument may be exposed to steam, salt or any corrosive gas.

The instrument case is made of ABS plastic and rubber: do not use any incompatible solvent for cleaning.

pH AND CONDUCTIVITY MEASUREMENTS - MOST FREQUENT PROBLEMS, POSSIBLE CAUSES AND HANDLING

Instrument functioning

- *When selecting some functions the “Operation reserved to the administrator” message is displayed on the screen.*

Some functions are reserved to the user registered as "Administrator". The other users cannot execute them (see the details on page 21).

- *Clicking on the LOG key the “Logging is disabled!” message is displayed on the screen.*

The logging interval was set to 0. To enable it, open the menu “*System Parameters >> Memory and Logging Options >> Select log interval*”, and select a log interval different from zero.

pH measurement

The average life of a pH electrode is about one year according to the use and maintenance performed.

The electrodes used at high temperatures or in highly alkaline environments have a shorter life.

It is recommended to condition the new electrodes for half day by immersing them, before use, into a buffer at 6.86pH or 4pH.

Calibrate the electrode with solutions closer to the values being measured. A new electrode must always be calibrated at neutral pH (6.86pH) first point, and at least a second point.

Generally, the pH electrodes have a body in glass: handle them with care to avoid breakage. In particular, the membrane (the sensitive element housed in the end part of the electrode) is made of very thin glass.

Some of the most frequent problems and their possible solutions are reported below.

Wrong pH measurement. Carry out the following checks:

- Check that the diaphragm is not obstructed and possibly clean it using the HD62PT solution.
- Check that the reference system is not contaminated. In case of a filling type electrode, replace the electrolyte with the suitable solution.
- Check that no air bubbles are present in the electrode tip and that it is sufficiently immersed.

Dirt residuals deposited on the membrane can alter the measurement: use the **HD62PP** solution for protein cleaning.

Slow response or wrong measurements. Possible causes are aging or erosion of the membrane or a connector short circuiting.

Storage. Keep the electrode immersed in the HD62SC solution.

Conductivity measurement

The service life of a cell can be unlimited, provided that the necessary maintenance is performed and that it does not break. Some of the most frequent problems and their possible solutions are reported below.

Measurement of conductivity different from the expected value.

Check that the probe is connected to the correct input: input ⑦, for a SICRAM type probe, input ⑧ for a direct type probe without SICRAM. Check that the cell used is suitable for the measurement range. Check that the cell is not dirty, that there are no air bubbles inside it. Repeat the calibration using the proper not contaminated standard.

Slow response or instability.

Check that the cell is not dirty, that there are no traces of oil or air bubbles inside it. If you work with a Platinum cell, new platinum-coating of the electrode could be necessary.

Cell constant K value not accepted.

Check that the standard solutions are in good condition, that the probe's constant cell value coincides with that selected in the instrument menu, and that the calibration solution temperature is within the range 15...35°C.

INSTRUMENT SIGNALS AND FAULTS

The following table lists all error indications and information displayed by the instrument and supplied to the user in different operating situations:

Display indication	Explanation
ERROR	This message appears if the pH measurement exceeds the -2.000pH...19.999pH limits. And if the mV measurement exceeds the $\pm 2.4V$ limits.
OVER	Measurement overflow: this appears when the probe measures a value exceeding the measurement range or the mV measurement is included in the +2.0...+2.4V range.
UNDR	Measurement overflow: this appears when the mV measurement is included in the -2.4...-2.0V range.
LOG MEM FULL	Memory full; the instrument cannot store further data, the memory space is full.
PROBE ERROR	A probe with SICRAM module has been inserted and not recognized by the instrument.
SYS ERR #	Instrument management program error. Contact the instrument's supplier and communicate the numeric code # reported by the display.
CAL LOST	Program error: it appears after turning on for a few seconds. Contact the instrument's supplier.
CAL blinking	Calibration not completed correctly.
BT blinking	In the models fitted with a Bluetooth HD22BT module, it means that the instrument is ready to send the data to the PC or Bluetooth printer. The symbol stops blinking when the connection is correctly established.
BT ERR	The two symbols blink alternately to indicate that no Bluetooth device has been found.

SERIAL INTERFACE AND USB

All instruments are fitted with an electrically isolated RS-232C serial interface, and an USB 2.0 interface. Optionally, they can be connected using a serial cable with sub D 9-pole female connectors (code **9CPRS232**) and a cable with USB 2.0 connectors (code **CP22**).

The USB connection requires the previous installation of a driver in the instrument software. **Install the driver before connecting the USB cable to the PC** (please see the details on page 46).

Standard parameters of the instrument serial transmission are:

- Baud rate 38400 baud
- Parity None
- N. bit 8
- Stop bit 1
- Protocol Xon/Xoff

It is possible to change the RS232C serial port baud rate by setting the "*Selection of the serial transmission speed (Baud Rate)*" parameter in the menu (please see page 18). The possible values are: 115200, 38400, 19200, 9600, 4800, 2400, 1200. The other transmission parameters are fixed.

The USB 2.0 connection does not require the setting of parameters.

The selection of the port is carried out directly by the instrument: if the USB port is connected to a PC, the RS232 serial port is automatically disabled.

All the commands transferred to the instrument must have the following structure:

XXCR where: **XX** is the command code and **CR** is the Carriage Return (ASCII 0D)

The XX command characters are exclusively upper case characters. Once a correct command is entered, the instrument responds with "&"; when any wrong combination of characters is entered, the instrument responds with "?".

The instrument response strings end with the sending of the CR (Carriage Return) and LF (Line Feed) command, preceded by the "]" character, that is, the combination "[CRLF".

Before sending commands to the instrument via the serial port, locking the keyboard to avoid functioning conflicts is recommended: use the P0 command. When complete, restore the keyboard with the P1 command.

COMMAND	ACTION	RESPONSE	NOTES
AA	Model request	HD2256-2 pH/chi/temperature	HD2205.2 = two pH channels HD2206.2 = conductivity HD2256.2 = pH+conductivity
AG	Firmware version	Firmware 1.00.100	
AH	Firmware date	2006_01_31	
AS	Serial number	Ser. Number=00000000	
AU	User identification	User=FACTORY User=Administrator User=User_1 User=User_2 User=User_3 User=Anonymous	

COMMAND	ACTION	RESPONSE	NOTES
AZ	Full heading	HD2256-2 Firmware 1.00.100 2006_01_31 Ser. number=00000000 Calibrated 01-FEB-06 00:01:00 User=Administrator Communication interface=USB Temp.comp. mode=AUTOMATIC Temp. sensor = Comb. Chi Pt100	
DA	Input date-time	&/?	"From 2005/12/12 12:34:56" It rejects any incorrect date
FA	Clock date request	060414092400	Current date "yy/mm/dd hh/mm/ss", HEX format
FB	Clock date request	01-JAN-06 00:33:27	Month name according to the language
FD	Instrument calibration request	060414092400	Calibration date "yy/mm/dd hh/mm/ss", HEX format
FE	Instrument calibration request	01-JAN-06 00:00:00	Month name according to the language
K1	Print current measurements	Same as manual print	It increases the ID
K2	Calibration status pH1	Same as manual print	
K3	Calibration status pH2	Same as manual print	Only HD2205.2
K4	Calibration history pH1	Same as manual print	
K5	Calibration history pH2	Same as manual print	Only HD2205.2
K6	Last conductivity calibration	Same as manual print	Only HD2206.2 and HD2256.2
KE	Exit from memory mode	&	
KL	Activate log	&	
KM	Activate memory display mode	&	Not accepted if no data present in the memory
KQ	Stop log + save operating pa- rameters	&	Use it also to only save the oper- ating parameters
KS	Single line continuous print- ing	&	
KT	Stop single line printing	&	
LDxxxx	Memory dump no. xxxx+1	Dump or ?	
LN	No. of next memory location request	Next avail. memory=0001	
LR	Setting of the displayed memory index	&/?	lr3 ---> shows memory no. 4
P0	Ping & lock keys	&	
P1	Ping & unlock keys	&	
RA	Read log interval	Print Interval= 000	
RE	Read current endpoint status	Endpoint mode = 0	
RF	Read parameter α_T	Chi alfa = 2.00	
RH	Read pH electrode calibration expiration	pH cal exp.days = 0	
RI	Read parameter ID	Sample ID= 00000001	

COMMAND	ACTION	RESPONSE	NOTES
RK	Read cell constant Kcell	Chi nominal Kcell = 0.700	
RL	Read parameter "Print and Storage Mode"	Print&mem = 0	0 = only print, 1 = print and record
RM	Read parameter "Storage Mode"	Memory mode = 0	0 = standard 1 = cyclic
RP	Read pH resolution	pH resolution = 1/1000	pH resolution: 1/100
RR	Read conductivity reference temperature	Chi ref temp= 25.00	
RS	Read conductivity TDS factor	Chi TDS factor= 0.500	
RT	Read temperature mode (ATC or MTC)	Temp_MODE = 0	0 = MTC 1 = ATC
RU	Read set units of measurement.	&0;0;1;0;	0 = pH, 1 = mV 0 = micros, 1 = ohm, 2 = TDS, 3 = NaCl 0 = °C, 1 = °F 0 = sat% 1 = mg/l
SH	Read pH calibration status	pH calibration status = valid pH calibration status = expired!	
Uxy	Setting of the displayed unit of measurement	x = 0...3 // pH, cond, temp, y = see the RU codes	
WA	Setting log interval	&/?	0...999
WE	Setting Endpoint mode	&/?	0 = endpoint "dir" 1 = endpoint "man" 2 = endpoint "time" 3 = endpoint "auto"
WF	Setting temperature coefficient α_T	&/?	0...400 = 0.00 ... 4.00 %
WH	Setting pH calibration validity number of days.	&/?	0 ... 999
WI	Setting sample identification number	&/?	00000000 ... 99999999
WL	Setting print and storage mode	&/?	0 = only print, 1 = print and record
WM	Setting storage mode	&/?	0 = linear logging mode 1 = cyclic logging mode (endless loop)
WP	Setting pH Resolution	&/?	0 = 2 decimal positions 1 = 3 decimal positions
WR	Setting conductivity reference temperature	&/?	0 ... 5000 = 0.00 50.00 °C
WS	Setting conductivity TDS factor	&/?	400 ... 800 = 0.400 ... 0.800
WT	Setting MTC temperature	&/?	-500 ... +1500 = -50 ... +150 °C

CONNECTION TO A PC

The instruments are fitted with two ports for connecting the instrument to the PC:

- RS232C serial port with null modem cable code **9CPRS232**. The cable has two sub D 9-pole female connectors.
- USB 2.0 port with the cable code **CP22**. The cable has a USB type A connector for PC connection and a USB type B connector for connection to the instrument.

The Bluetooth **HD22BT** module, directly installed by Delta Ohm, is also available. This module allows wireless connection of the instrument to a PC fitted with a Bluetooth HD USB.KL1, to a Bluetooth *S'Print-BT* printer, or to a PC with built-in Bluetooth interface.

The instrument are supplied with the **DeltaLog11 software**. The software manages the connection, data transfer, graphic presentation, and printing operations of the captured or logged measurements. **The DeltaLog11 software is complete with "On-line Help" (also in PDF format) describing its characteristics and functions.**

The instruments are also compatible with the HyperTerminal communication program supplied with the Windows operating systems (from Windows 98 to Windows XP).

CONNECTION TO THE RS232C SERIAL PORT

1. The measuring instrument has to be switched off.
2. Using the null-modem Delta Ohm 9CPRS232 cable, connect the measurement instrument to the first free serial port (COM) of the PC.
3. Turn on the instrument and set the baud rate to 115200 (SETUP >> "SYSTEM PARAMETERS" >> "*Selection of the serial transmission speed (Baud Rate)*" select 115200 using the arrows >> confirm with ENTER). The parameter remains in the memory.
4. Launch the DeltaLog11 application and press CONNECT. Wait for the connection to occur and follow the indications on the screen. For a description of the DeltaLog11 application, please refer to its On-line Help.

CONNECTION TO THE USB 2.0 PORT

The USB connection requires the installation of the drivers. They are contained in the DeltaLog11 CD-Rom.

Proceed as follows:

1. **Do not connect the instrument to the USB port until you are expressly requested to do it.**
2. Insert the DeltaLog11 CD-Rom and select the "*Install/Remove USB driver*" item.
3. The application checks the presence of the drivers on the PC: the installation starts if they are not present; if they are already installed, the drivers are removed by pressing the key.
4. The installation wizard prompts the software user license: to proceed, **the software usage terms must be accepted - click on YES.**
5. On the next page the folder where the drivers will be installed is indicated: confirm without modifying.
6. Complete the installation by clicking on *Finish*. Wait few seconds until the DeltaLog11 page appears.

7. Close DeltaLog11.
8. Connect the instrument to the PC USB port. When Windows detects the new device, the "*New software installation wizard*" is started.
9. If you are asked for the authorization to search an updated driver, answer *NO* and continue.
10. In the installation window, select "*Install from a list or specific location*".
11. In the next window select "*Search for the best driver in these locations*" and "*Include this location in the search*".
12. Using *Browse*, indicate the installation folder provided at point 5:

C:\Program Files\Texas Instruments\USB-Serial Adapter

 Confirm with *OK*.
13. If you get the message that the software did not pass the Windows Logo testing, select "*Continue*".
14. The USB driver are installed: at the end, click on "*Finish*".
15. **The installation wizard requests the files location once more:** repeat the just described steps and provide the location of the same folder (see point 12).
16. **Wait:** the operation could take a few minutes.
17. The installation procedure is now complete: the device will be detected on each new connection automatically.

In order to check if the entire operation was successful, in CONTROL PANEL double click on SYSTEM. Select "Device Manager" and connect the instrument to the USB port.

The following items should appear:

- "*UMP Devices >> UMP3410 Unitary driver*" and "*Porte (COM and LPT) >> UMP3410 Serial Port (COM#)*" for Windows 98 and Windows Me,
- "*Schede seriali Multiport >> TUSB3410 Device*" and "*Porte (COM and LPT) >> USB-Serial Port (COM#)*" for Windows 2000, NT and XP.

When the USB cable is disconnected, these two items disappear and come back when it is connected again.

Notes.

1. If the instrument is connected to the USB port **before** installing the drivers, Windows signals the presence of an unknown device: in this case, cancel the operation and repeat the procedure illustrated at the beginning of this section.
2. **In the documentation supplied with the DeltaLog11 CD-Rom, is included a detailed version of this chapter with pictures. Moreover, the necessary steps to remove the USB drivers are reported.**

BLUETOOTH CONNECTION

The instruments can be wireless connected to a PC or printer, via a Bluetooth connection that requires installation of the **HD22BT** module by Delta Ohm.

For connection to a PC, if the PC is not fitted with a Bluetooth interface, you need to connect the USB/Bluetooth interface, code **HD USB.KL1**. The interface is connected to a USB port on the PC, and is supplied with its own drivers that have to be installed on the PC.

The HD22BT module drivers are contained in the DeltaLog11 CD-Rom.

The instrument parameters for the Bluetooth module are reported in the menu at the item "SYSTEM PARAMETERS" >> "*Bluetooth Parameters*" (see the details on page 19).

In the documentation supplied with the DeltaLog11 CD-Rom, is included the detailed "*Bluetooth Connection*" guide, that illustrates the installation and use of the Bluetooth module for connection to the PC and for printing.

STORING AND TRANSFERRING DATA TO A PC

The HD2205.2, HD2206.2 and HD2256.2 instruments can be connected to a personal computer via an RS232C serial port or an USB port, and exchange data and information through the DeltaLog11 software running in a Windows operating environment (see the details on the previous chapter). All models can print the measured values on (*S'print-BT*) a 24 column printer (PRINT key) and store them in the internal memory using the logging function (MEM key). The stored data can be recalled to be viewed directly on the instrument display, printed or transferred to the PC.

They can also transfer the data wireless to a PC, if the instruments and the PC are fitted with a Bluetooth interface.

THE RECORD FUNCTION

The instrument allows the recording of up to 2000 screens in its memory. each screen is made of the measurements detected by the probes connected to the inputs. The stored parameters are those shown on the display and selected using the F1, F2 keys.

Two recording modes are available: one upon command and the other continuous.

- The *on command* mode memorizes the current screen by pressing **MEM** or “**SHIFT/FNC**” >> “**F1 = M-STOR**”.
- The *continuous* mode memorizes the screens according to an interval that can be set in the menu.

The logging starts by pressing the **LOG** key and ends by pressing the same key again: the data memorized form a continuous block of data.

The logging interval can be set from 1 to 999 seconds. To enable it, open the menu “*System Parameters >> Memory and Logging Options >> Select log interval*” (see the description of the menu items on page 17).

The data stored in the memory can be transferred to a PC using the DeltaLog11 software: please see the software help for the details.

To display the recorded data directly on the instrument display, press the “**SHIFT/FNC**” and then the “**F5 = M-VIEW**” key.

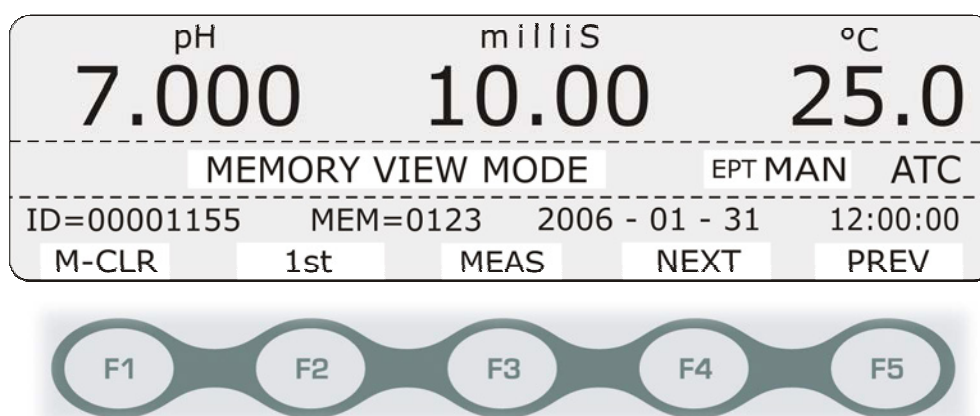

To browse the recorded data use the function keys:

“**F2 = 1st**” to display the first data on memory

“**F4 = NEXT**” to see the next sample

“**F5 = PREV**” to see the previous sample

To print the current screen, press the **PRINT** key.

To return to measurement, press “**F3 = MEAS**”.

CLEARING THE MEMORY

To clear the memory, start the stored data display mode by pressing “**SHIFT/FNC**” >> “**F5 = M-VIEW**”. Press the “**F1 = M-CLR**” function key.

The window to confirm the operation will appear: “CLEAR MEMORY???”. Press the “**F1 = NO**” function key to cancel the operation, or the “**F5 = YES**” function key to confirm.

The instrument starts clearing the internal memory; at the end of the operation, it goes back to normal display.

NOTES:

- The data transfer carried out using the DeltaLog11 software does not cause the memory to be erased; the operation can be repeated as many times as required.
- The recorded data remain in the memory even if the instrument is turned off or disconnected from the mains, if the recording was complete.
- **Memory clearing can be performed only by the administrator** (see page 21).

THE PRINT FUNCTION

Press **PRINT** to send the measured data directly to the RS232 or USB ports, in real time. Print data units of measurements are the same as those used on the display, as selected using the F1 and F2 function keys.

A printer with serial input can be connected to the RS232C port (e.g. the Delta Ohm 24 column printer code *S'print-BT*).

The RS232C and USB ports can be connected to the corresponding ports on the PC using the appropriate cables: 9CPRS232 for the RS232C serial, CP22 for the USB. The Bluetooth wireless connection requires installation of the **HD22BT** module (see the previous chapter).

The instruments detect automatically the presence of a connection to the USB port: in this case the RS232C serial port is disabled. The Bluetooth connection disables both RS232C and USB ports.

NOTES:

- The print out is formatted across 24 columns.
- In order to print the data to a parallel interface printer, you must use a parallel-serial adaptor (not supplied).
- **The direct connection between instrument and printer via a USB connector does not work.**

NOTES

```
HD2256.2
pH/chi/temperature
2006 - 01 - 31 12:00:00
LAB POSITION #1

Operator = Administrator

SAMPLE ID = 00000001

pH EL sernum = 01234567
pH = 7.010
pH out of calibration !

chi EL sernum = 76543210
microS = 199.9

Temp = 25.0°C ATC
```

Instrument model

Current date and time in the format
year-month-day hours:minutes:seconds

Instrument name

Operator (Administrator or User_1, User_2,
User_3 or Anonymous)

Number of the sample

Serial number of the pH electrode

pH measurement
The calibration validity period has expired (other-
wise the calibration date is shown)

Conductivity probe serial number

Conductivity measurement

Temperature measurement
ATC = automatic compensation
MTC = manual compensation

BACKUP BATTERY REPLACEMENT

The instruments are fitted with a backup battery that maintains the configuration data in the memory and ensures the functioning of the clock without power supply.

The battery operates only when the instrument is not powered by the mains. The low power consumption ensures a long life of the battery.

The battery charge status is constantly monitored: When the battery is low, the BACKUP BATTERY LOW!!! message is displayed: The battery must be replaced as soon as possible.

The 3.6V type ½AA Lithium battery (diameter x length = 14mm x 25mm) with axial rheophores: In the following picture is shown a battery in its correct position, the positive pole is directed downwards.

Before replacing the discharged battery, complete the logging operations in progress, and turn the instrument off.

To avoid losing the configuration data, the battery change should not take over one minute, otherwise the instrument has to be reconfigured.

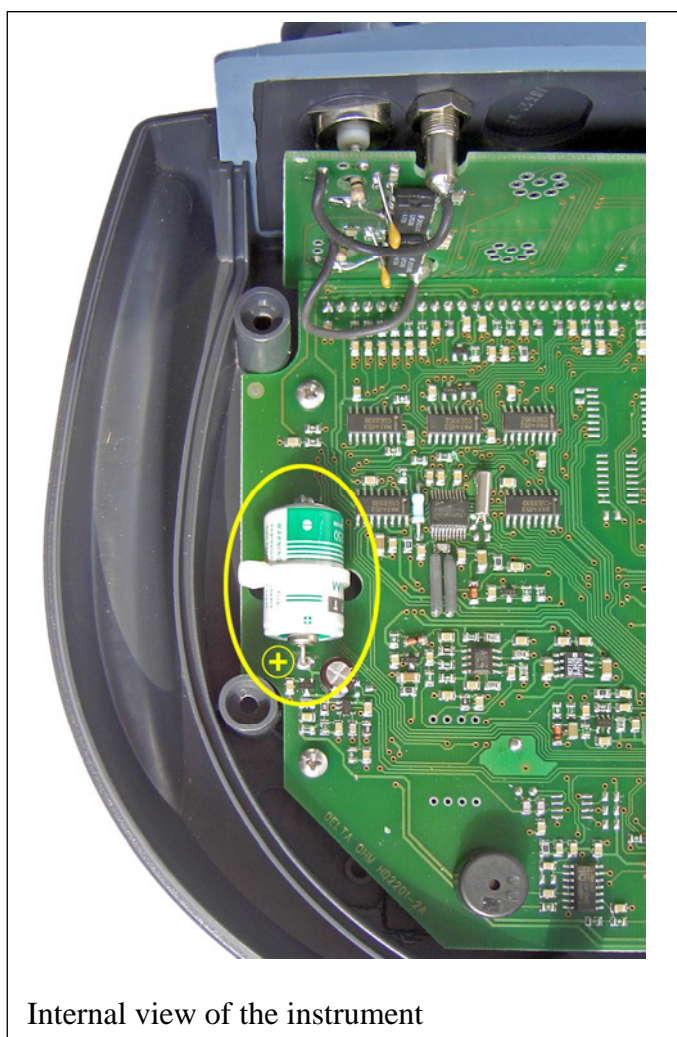

Procedure

1. Unscrew the 6 screws on the back.
2. Lift the front making sure the flat cables that connect the various instrument parts are not disconnected.
3. Cut the rheophores of the new battery to a length of about 15 mm.



4. Cut the strip blocking the discharged battery to the printed circuit.
5. Remove the discharged battery.
6. Put the new battery in **making sure the polarity is correct: the negative pole is directed toward the back.**
7. Fix the battery with a new strip.
8. Close the instrument back using the 6 screws.

Authorized use

The instrument has been designed exclusively for laboratory measurements. Comply with the technical specifications outlined in the chapter TECHNICAL DATA on page 56. Its use is authorized only in conformity with the instructions written in this manual. Any different use is considered improper.

General instructions on security

This instrument has been manufactured and tested according to safety regulation EN 61010-1 concerning electronic measurement instruments and was delivered ex factory in perfect security conditions.

Its regular functioning and operating security can be ensured only if all the normal safety measures as well as the specifications described in this manual are complied with.

Its regular functioning and operating security is ensured only within the climatic conditions specified in the chapter TECHNICAL DATA on page 56.

If the instrument is moved from a cold to a hot environment, or vice versa, the condensation can disturb its functioning. You need to wait for the instrument to reach the environment temperature before using it.

User obligations

The user of the instrument must ensure that the following regulations and directives concerning the handling of hazardous materials are complied with:

- CEE directives on job safety
- National laws on job safety
- Accident prevention regulations
- Security data from the manufacturers of chemical substances.

HD22.2 LABORATORY ELECTRODE HOLDER WITH IN-BUILT MAGNETIC STIRRER

HD22.3 LABORATORY ELECTRODE HOLDER









HD22.2

The HD22.2 is a laboratory electrode holder with an ultra slim magnetic stirrer. The height adjustable electrode holder supports two standard \varnothing 12 mm electrodes. The stirring is performed by a small magnetic bar immersed in the liquid: The motion is generated by a rotary magnetic field controlled by microprocessor. There are no mechanically moving parts, therefore no maintenance is required.



The rotational speed can constantly be adjusted from 15 to 1500 rpm.

The HD22.2 has a modern and functional design. It is made of materials that resist to most chemical products.

Operation

- Insert the magnetic bar in the liquid container to be stirred.
- Power the stirrer by connecting the SWD10 power supply 12Vdc output (optional) or connecting it to the instrument's auxiliary supply output (series HD22xx.2) using the HD22.2.1 cable.
- Turn the instrument on with the  key.
- Set the rotational speed to the minimum by holding the  key, until the LED located between the  and  keys stops blinking.
- Now put the liquid container, at the center of the base.
- Set the desired rotational speed by pressing the  and  keys; during adjustment the LED located between the two keys is blinking.
- The  key allows to invert the magnetic bar rotation. The lit LED between the  and  keys, indicates that the inversion function is on; the rotation direction is automatically inverted every 30 seconds.

The set speed and rotation direction remain in the memory also when the instrument is off. Upon power on, the rotation will progressively go back to the previously set speed.

Note: If a non circular rotational motion begins, due to irregularities in the bottom of the container or the magnetic bar, use the  and  keys to restore a circular motion.

The electrode holder height can be adjusted. To set the desired height, press the button and slide the electrode holder along the staff.

HD22.3

The HD22.3 is a laboratory staff and electrode holder. Its height and depth can be adjusted. It can hold up to 5 standard \varnothing 12 mm electrodes. The solid, fire-coated metal base, ensures stability even with 5 electrodes. The staff is fitted with hooks for cables and electrodes.

Technical Information	HD22.2	HD22.3
Power	12Vdc, 200mA	---
Stirring speed	15...1500 rpm	---
Stirring capacity	Max. 1000 ml	---
Stirring magnetic bar	L = 30...40 mm	---
Material	Body ABS; staff AISI 304	Body ABS; base Fe 360
Weight	1150g	1900g
Bearing surface	Ø 100 mm	---
Dimensions	Base: 215x145x25 mm Staff: height 380 mm	Height max. 450 mm.
Environment temperature, % RH	0...50 °C, max. 85% RH without condensation	
No. of housings for the electrodes	Up to four Ø 12 mm electrodes and one Ø 4.5 mm breakable to Ø 12 mm	
Protection degree	IP65	



HD22.2



HD22.3

COMMON TECHNICAL CHARACTERISTICS OF THE HD22... SERIES

Instrument

Dimensions (Length x Width x Height)	265x190x75mm
Weight	1300 g
Materials	ABS, rubber
Display	Backlit, Dot Matrix. 240x64 points, visible area: 128x35mm

Operating conditions

Operating temperature	-5...50°C
Warehouse temperature	-25...65°C
Working relative humidity	0...90% RH without condensation
Protection degree	IP66

Power

Mains adapter (code SWD10)	12Vdc/1A
Auxiliary supply output socket	12Vdc/200mA to power the HD22.2 electrode holder with built-in magnetic stirrer

Security of stored data

Unlimited

Time

Date and time	Real time clock with 3.6V - ½AA backup battery
Accuracy	1min/month max departure

Measured values memorization

Quantity	2000 screens
Storage interval	1s ... 999s

Storage of calibrations

pH	Last 8 pH calibrations. The last 2 calibrations are stored in the pH probe's SICRAM memory.
Conductivity	The last calibration is saved in the probe's SICRAM memory or in the instrument memory if the probe is without SICRAM.

RS232C serial interface

Type	RS232C electrically isolated
Baud rate	Can be set from 1200 to 115200 baud
Data bit	8
Parity	None
Stop bit	1
Flow Control	Xon/Xoff
Serial cable length	Max. 15 m

USB interface

Type	1.1 - 2.0 electrically isolated
------	---------------------------------

Bluetooth interface

Optional, for PC fitted with Bluetooth input or Bluetooth/RS232 HD USB.KL1 adaptor. The interface can be installed only by Delta Ohm

EMC Standard Regulations

Safety	EN61000-4-2, EN61010-1 level 3
Electrostatic discharges	EN61000-4-2 level 3
Fast electric transients	EN61000-4-4 level 3, EN61000-4-5 level 3
Voltage variations	EN61000-4-11
Electromagnetic interference susceptibility	IEC1000-4-3
Electromagnetic interference emission	EN55020 class B

HD2205.2 TECHNICAL CHARACTERISTICS

pH - mV - °C - °F MEASUREMENT

<i>Measured quantities</i>	pH - mV °C - °F;
<i>Connections</i>	
Input for the temperature probes with SICRAM module ⑤	8-pole male DIN45326 connector
pH/mV inputs ① - ②	Female BNC
Socket for the reference electrode	∅ 4mm standard plug
Inputs ③ and ④ SICRAM module pH/temperature	8-pole male DIN45326 connector
Serial interface	DB9 connector (male 9-pole)
USB interface	USB connector type B
Bluetooth	Optional
Mains power supply	2-pole connector (∅5.5mm-2.1mm). Positive at centre.
Power supply socket for the electrode holder with built-in magnetic stirrer	2-pole connector (∅5.5mm-2.1mm). Positive at centre (12Vdc/200mA max. output).
• <i>Measurement of pH by Instrument</i>	
Measurement range	-9.999...+19.999pH
Resolution	0.01 or 0.001pH selectable from menu
Accuracy	±0.001pH ±1digit
Input impedance	>10 ¹² Ω
Calibration error @25°C	Offset > 20mV Slope > 63mV/pH or Slope < 50mV/pH Sensitivity > 106.5% or Sensitivity < 85%
Calibration points	Up to 5 points selected among 13 automatically detected buffer solutions
Temperature compensation	-50...150°C
Standard solutions detected automatically @25°C	1.679pH - 2.000pH - 4.000pH - 4.008pH - 4.010pH - 6.860pH - 6.865pH - 7.000pH - 7.413pH - 7.648pH - 9.180pH - 9.210pH - 10.010pH
<i>Measurement of mV by Instrument</i>	
Measurement range	-1999.9...+1999.9mV
Resolution	0.1mV
Accuracy	±0.1mV ±1digit
Drift after 1 year	0.5mV/year

• *Measurement of temperature by Instrument*

Pt100 measurement range	-50...+150°C
Pt1000 measurement range	-50...+150°C
Resolution	0.1°C
Accuracy	±0.1°C ±1digit
Drift after 1 year	0.1°C/year

HD2206.2 TECHNICAL CHARACTERISTICS

χ - Ω - TDS - NaCl - °C - °F MEASUREMENT

Measured quantities

χ - Ω - TDS - NaCl
°C - °F;

Connections

Input for the temperature probes
with SICRAM module ⑤

8-pole male DIN45326 connector

4-ring/2-ring conductivity direct input ⑧

8-pole male DIN45326 connector

SICRAM probes conductivity input ⑦

8-pole male DIN45326 connector

Serial interface

DB9 connector (male 9-pole)

USB interface

USB connector type B

Bluetooth

Optional

Mains power supply

2-pole connector (Ø5.5mm-2.1mm). Positive at centre

Power supply socket for the electrode holder with
built-in magnetic stirrer

2-pole connector (Ø5.5mm-2.1mm). Positive at centre (12Vdc/200mA output max.).

• *Measurement of conductivity by Instrument*

Measurement range (Kcell=0.01) / Resolution

0.000...1.999 μ S/cm / 0.001 μ S/cm

Measurement range (Kcell=0.1) / Resolution

0.00...19.99 μ S/cm / 0.01 μ S/cm

Measurement range (Kcell=1) / Resolution

0.0...199.9 μ S/cm / 0.1 μ S/cm

200...1999 μ S/cm / 1 μ S/cm

2.00...19.99mS/cm / 0.01mS/cm

20.0...199.9mS/cm / 0.1mS/cm

Measurement range (Kcell=10) / Resolution

200...1999mS/cm / 1mS/cm

Accuracy (conductivity)

$\pm 0.5\%$ ± 1 digit

Measurement of resistivity by Instrument

Measurement range (Kcell=0.01) / Resolution	Up to 1GΩ·cm / (*)Measurement range
(Kcell=0.1) / Resolution	Up to 100MΩ·cm / (*)Measurement
range (Kcell=1) / Resolution	5.0...199.9Ω·cm / 0.1Ω·cm
	200...999Ω·cm / 1Ω·cm
	1.00k...19.99kΩ·cm / 0.01kΩ·cm
	20.0k...99.9kΩ·cm / 0.1kΩ·cm
	100k...999kΩ·cm / 1kΩ·cm
	1...10MΩ·cm / 1MΩ·cm
Measurement range (Kcell=10) / Resolution	0.5...5.0Ω·cm / 0.1Ω·cm
Accuracy (resistivity)	±0.5% ±1digit

Measurement of total dissolved solids (with coefficient $\chi/TDS=0.5$)

Measurement range (Kcell=0.01) / Resolution	0.00...1.999mg/l / 0.005mg/l
Measurement range (Kcell=0.1) / Resolution	0.00...19.99mg/l / 0.05mg/l
Measurement range (Kcell=1) / Resolution	0.0...199.9 mg/l / 0.5 mg/l
	200...1999 mg/l / 1 mg/l
	2.00...19.99 g/l / 0.01 g/l
	20.0...199.9 g/l / 0.1 g/l
Measurement range (Kcell=10) / Resolution	100...999 g/l / 1 g/l
Accuracy (total dissolved solids)	±0.5% ±1digit

Measurement of salinity

Measurement range / Resolution	0.000...1.999g/l / 1mg/l
	2.00...19.99g/l / 10mg/l
	20.0...199.9 g/l / 0.1 g/l
Accuracy (salinity)	±0.5% ±1digit

Automatic/manual temperature compensation

0...100°C with $\alpha_T = 0.00...4.00\%/^{\circ}\text{C}$

Reference temperature

0...50°C (**default 20°C or 25°C**)

χ/TDS conversion factor

0.4...0.8

Preset cell constant K (cm^{-1})

0.01 - 0.1 - 0.5 - 0.7 - 1.0 - 10.0

Cell constant K (cm^{-1}) that can be set by the user

0.01...20.00

(*) The resistivity measurement is defined as the reciprocal of conductivity: the resistivity indication, near bottom scale, will appear as in the following table.

K cell = 0.01 cm^{-1}		K cell = 0.1 cm^{-1}	
Conductivity ($\mu\text{S}/\text{cm}$)	Resistivity ($\text{M}\Omega\cdot\text{cm}$)	Conductivity ($\mu\text{S}/\text{cm}$)	Resistivity ($\text{M}\Omega\cdot\text{cm}$)
0.001 $\mu\text{S}/\text{cm}$	1000 $\text{M}\Omega\cdot\text{cm}$	0.01 $\mu\text{S}/\text{cm}$	100 $\text{M}\Omega\cdot\text{cm}$
0.002 $\mu\text{S}/\text{cm}$	500 $\text{M}\Omega\cdot\text{cm}$	0.02 $\mu\text{S}/\text{cm}$	50 $\text{M}\Omega\cdot\text{cm}$
0.003 $\mu\text{S}/\text{cm}$	333 $\text{M}\Omega\cdot\text{cm}$	0.03 $\mu\text{S}/\text{cm}$	33 $\text{M}\Omega\cdot\text{cm}$
0.004 $\mu\text{S}/\text{cm}$	250 $\text{M}\Omega\cdot\text{cm}$	0.04 $\mu\text{S}/\text{cm}$	25 $\text{M}\Omega\cdot\text{cm}$

Standard solutions automatically detected (@25°C)

147µS/cm

1413µS/cm

12880µS/cm

111800µS/cm

• *Measurement of temperature by Instrument*

Pt100 measurement range

-50...+150°C

Pt1000 measurement range

-50...+150°C

Resolution

0.1°C

Accuracy

±0.1°C ±1digit

Drift after 1 year

0.1°C/year

HD2256.2 TECHNICAL CHARACTERISTICS

pH – mV - χ - Ω - TDS - NaCl - °C - °F MEASUREMENT

Measured quantities

pH - mV
 χ - Ω - TDS - NaCl
 °C - °F;

Connections

Input for the temperature probes with SICRAM module ⑤	8-pole male DIN45326 connector
pH/mV input ①	Female BNC
Socket for the reference electrode	Ø 4mm standard plug
pH/ temperature input with SICRAM module ③	8-pole male DIN45326 connector
4-ring/2-ring conductivity direct input ⑧	8-pole male DIN45326 connector
SICRAM probes conductivity input ⑦	8-pole male DIN45326 connector
Serial interface	DB9 connector (male 9-pole)
USB interface	USB connector type B
Bluetooth	Optional
Mains power supply	2-pole connector (Ø5.5mm-2.1mm). Positive at centre
Power supply socket for the electrode holder with built-in magnetic stirrer	2-pole connector (Ø5.5mm-2.1mm). Positive at centre (12Vdc/200mA output max.).

• *Measurement of pH by Instrument*

Measurement range	-9.999...+19.999pH
Resolution	0.01 or 0.001pH selectable from menu
Accuracy	±0.001pH ±1digit
Input impedance	>10 ¹² Ω
Calibration error @25°C	Offset > 20mV Slope > 63mV/pH or Slope < 50mV/pH Sensitivity > 106.5% or Sensitivity < 85%
Temperature compensation	-50...150°C
Calibration points	Up to 5 points selected among 13 automatically detected buffer solutions
Standard solutions detected automatically @25°C	1.679pH - 2.000pH - 4.000pH - 4.008pH - 4.010pH - 6.860pH - 6.865pH - 7.000pH - 7.413pH - 7.648pH - 9.180pH - 9.210pH - 10.010pH

Measurement of mV by Instrument

Measurement range	-1999.9...+1999.9mV
Resolution	0.1mV
Accuracy	±0.1mV ±1digit
Drift after 1 year	0.5mV/year

• *Measurement of conductivity by Instrument*

Measurement range (Kcell=0.01) / Resolution	0.000...1.999 μ S/cm / 0.001 μ S/cm
Measurement range (Kcell=0.1) / Resolution	0.00...19.99 μ S/cm / 0.01 μ S/cm
Measurement range (Kcell=1) / Resolution	0.0...199.9 μ S/cm / 0.1 μ S/cm
	200...1999 μ S/cm / 1 μ S/cm
	2.00...19.99mS/cm / 0.01mS/cm
	20.0...199.9mS/cm / 0.1mS/cm
Measurement range (Kcell=10) / Resolution	200...1999mS/cm / 1mS/cm
Accuracy (conductivity)	$\pm 0.5\%$ ± 1 digit

Measurement of resistivity by Instrument

Measurement range (Kcell=0.01) / Resolution	Up to 1G Ω ·cm / (*)
Measurement range (Kcell=0.1) / Resolution	Up to 100M Ω ·cm / (*)
Measurement range (Kcell=1) / Resolution	5.0...199.9 Ω ·cm / 0.1 Ω ·cm
	200...999 Ω ·cm / 1 Ω ·cm
	1.00k...19.99k Ω ·cm / 0.01k Ω ·cm
	20.0k...99.9k Ω ·cm / 0.1k Ω ·cm
	100k...999k Ω ·cm / 1k Ω ·cm
	1...10M Ω ·cm / 1M Ω ·cm
Measurement range (Kcell=10) / Resolution	0.5...5.0 Ω ·cm / 0.1 Ω ·cm
Accuracy (resistivity)	$\pm 0.5\%$ ± 1 digit

Measurement of total dissolved solids (with coefficient $\chi/TDS=0.5$)

Measurement range (Kcell=0.01) / Resolution	0.00...1.999mg/l / 0.005mg/l
Measurement range (Kcell=0.1) / Resolution	0.00...19.99mg/l / 0.05mg/l
Measurement range (Kcell=1) / Resolution	0.0...199.9 mg/l / 0.5 mg/l
	200...1999 mg/l / 1 mg/l
	2.00...19.99 g/l / 0.01 g/l
	20.0...199.9 g/l / 0.1 g/l
Measurement range (Kcell=10) / Resolution	100...999 g/l / 1 g/l
Accuracy (total dissolved solids)	$\pm 0.5\%$ ± 1 digit

(*) The resistivity measurement is defined as the reciprocal of conductivity: the resistivity indication, near bottom scale, will appear as in the following table.

K cell = 0.01 cm ⁻¹		K cell = 0.1 cm ⁻¹	
Conductivity (μ S/cm)	Resistivity (M Ω ·cm)	Conductivity (μ S/cm)	Resistivity (M Ω ·cm)
0.001 μ S/cm	1000 M Ω ·cm	0.01 μ S/cm	100 M Ω ·cm
0.002 μ S/cm	500 M Ω ·cm	0.02 μ S/cm	50 M Ω ·cm
0.003 μ S/cm	333 M Ω ·cm	0.03 μ S/cm	33 M Ω ·cm
0.004 μ S/cm	250 M Ω ·cm	0.04 μ S/cm	25 M Ω ·cm
...

Measurement of salinity

Measurement range / Resolution

0.000...1.999g/l / 1mg/l

2.00...19.99g/l / 10mg/l

20.0...199.9 g/l / 0.1 g/l

Accuracy (salinity)

±0.5% ±1digit

Automatic/manual temperature compensation

0...100°C with $\alpha_T = 0.00...4.00\%/^{\circ}\text{C}$

Reference temperature

0...50°C (**default 20°C or 25°C**)

χ /TDS conversion factor

0.4...0.8

Preset cell constant K (cm^{-1})

0.01 - 0.1 - 0.5 - 0.7 - 1.0 - 10.0

Cell constant K (cm^{-1}) that can be set by the user

0.01...20.00

Standard solutions automatically detected (@25°C)

147 $\mu\text{S}/\text{cm}$

1413 $\mu\text{S}/\text{cm}$

12880 $\mu\text{S}/\text{cm}$

111800 $\mu\text{S}/\text{cm}$

• *Measurement of temperature by Instrument*

Pt100 measurement range

-50...+150°C

Pt1000 measurement range

-50...+150°C

Resolution

0.1°C

Accuracy

±0.1°C ±1digit

Drift after 1 year

0.1°C/year

TECHNICAL DATA IN LINE PROBES FOR THE INSTRUMENTS OF THE SERIES HD22...

HD2205.2 AND HD2256.2 pH ELECTRODES ① ②

pH electrodes without SICRAM module

ORDER CODE	MEASUREMENT RANGE	DIMENSIONS
KP20	<p>0...14pH / 0...80°C / 3bar Body in glass - GEL 1 diaphragm in ceramic Waste water, drinking water, colours, aqueous emulsions, electroplating waters, fruit-juices, stock waters, titration, varnishes.</p>	
KP30	<p>0...14pH / 0...80°C / 3bar Body in glass - GEL 1 diaphragm in ceramic Cable L=1m with BNC Waste water, drinking water, aqueous emulsions, electroplating waters, colours, varnishes, stock waters, fruit-juices, titration.</p>	
KP50	<p>0...14pH / 0...80°C / 3bar Body in glass - GEL 1 Teflon ring diaphragm Varnishes, cosmetics, aqueous emulsions, electroplating waters, creams, deionised water, TRIS buffer, drinking water, stock waters, fruit-juices, low ionic content solutions, mayonnaise, preserved foods, colours, titration, titration in non water solutions, stock waters, soaps, waste water, viscous samples.</p>	
KP61	<p>2...14pH / 0...80°C / 3bar Body in glass Liquid reference 3 diaphragms in ceramic Waste water, dough, bread, fruit-juices, varnishes, cosmetics, creams, deionised water, drinking water, aqueous emulsions, electroplating waters, soaps yogurt, milk, titration, titration in non water solutions, stock waters, mayonnaise, wine, low ionic content solutions, butter, protein samples, colours, viscous samples.</p>	

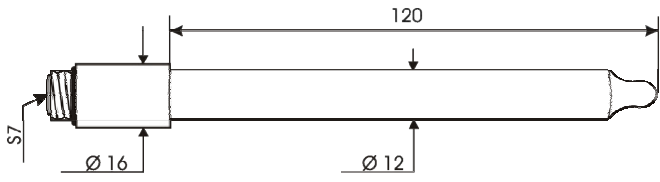
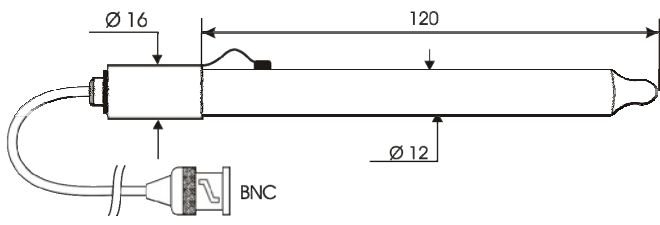
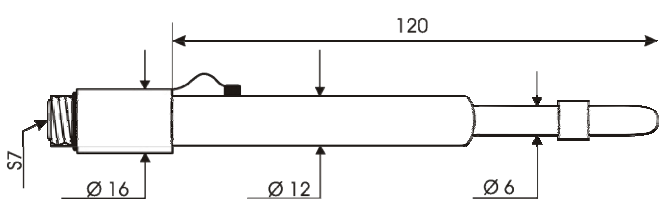
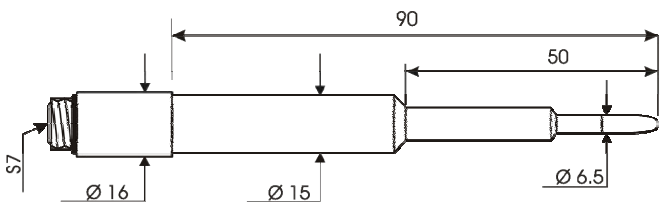
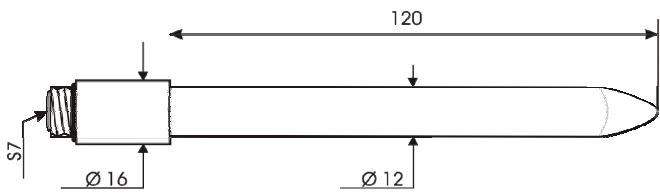
ORDER CODE	MEASUREMENT RANGE	DIMENSIONS
KP62	0...14pH / 0...80°C / 3bar Body in glass - GEL 1 diaphragm in ceramic Colours, varnishes, drinking water, aqueous emulsions, fruit-juices, electroplating waters, stock waters, titration, waste water.	
KP63	0...14pH / 0...80°C / 1bar Body in glass Liquid reference KCl 3M 1 diaphragm in ceramic Cable L=1m with BNC Colours, varnishes, drinking water, aqueous emulsions, fruit-juices, electroplating waters, stock waters, titration, waste water.	
KP64	0...14pH / 0...80°C / 0.1bar Body in glass Liquid reference KCl 3M Teflon ring diaphragm Colours, varnishes, cosmetics, creams, deionised water, drinking water, aqueous emulsions, fruit-juices, soaps, low ionic content solutions, mayonnaise, preserved foods, stock waters, titration, titration in non water solutions, TRIS buffer, waste water, viscous samples, wine.	
KP70	2...14pH / 0...50°C / 0.1bar Body in glass - GEL 1 open hole Dough, bread, colours, varnishes, creams, drinking water, aqueous emulsions, fruit-juices, electroplating waters, soaps, mayonnaise, preserved foods, cheese, milk, stock waters, viscous samples, waste water, butter, yogurt.	
KP80	2...14pH / 0...60°C / 1bar Body in glass - GEL 1 open hole Dough, bread, colours, varnishes, cosmetics, creams, drinking water, aqueous emulsions, fruit-juices, electroplating waters, soaps, mayonnaise, preserved foods, stock waters, titration, titration in non water solutions, viscous samples, waste water, yogurt, milk, butter.	

pH electrodes with SICRAM module ③ ④

ORDER CODE	MEASUREMENT RANGE	DIMENSIONS
KP63TS	0...14pH / 0...80°C / 1bar Body in glass. Pt100 sensor Liquid reference KCl 3M 1 diaphragm in ceramic Cable L = 1m Colours, varnishes, drinking water, aqueous emulsions, fruit-juices, electroplating waters, stock waters, titration, waste water.	
KP47	Please see the technical characteristics of the electrode connected to the module.	BNC

HD2205.2 AND HD2256.2 REDOX ELECTRODES ① ②

ORDER CODE	MEASUREMENT RANGE AND USE	DIMENSIONS
KP90	±2000mV 0...80°C 5 bar Body in glass Liquid reference KCl 3M General use	
KP91	±1000mV 0...60°C 1 bar Body in glass - GEL Cable L=1m with BNC General use Not heavy duty	

2 AND 4 ELECTRODE CONDUCTIVITY PROBES FOR HD2206.2 AND HD2256.2

Conductivity probes without SICRAM module ⑧

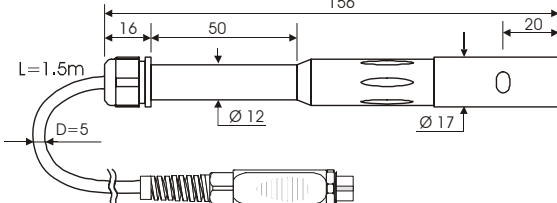
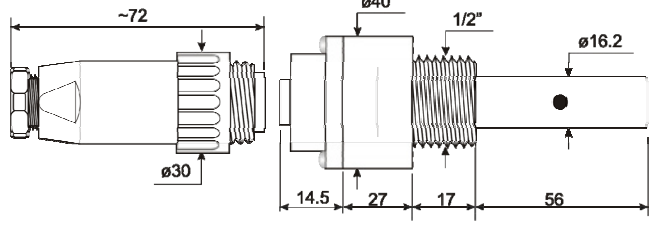
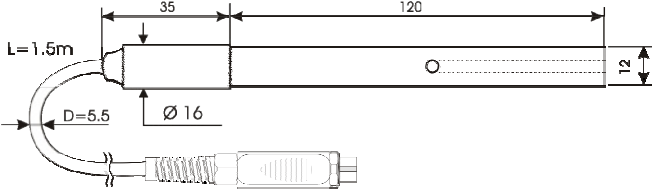
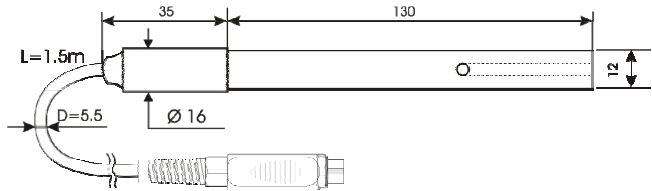
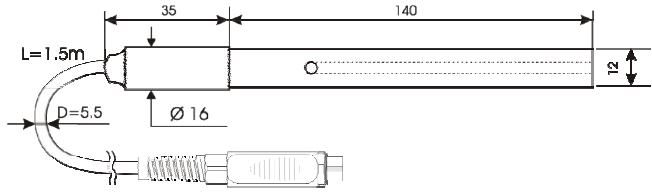
ORDER CODE	MEASUREMENT RANGE AND USE	DIMENSIONS
SP06T	<p align="center">K=0.7 5µS/cm ... 200mS/cm 0...90°C 4-electrode cell in Platinum Pocan probe material General use Not heavy duty Pt100 sensor</p>	
SPT401.001	<p align="center">K=0.01 0.04µS/cm ... 20µS/cm 0...120°C 2-electrode cell AISI 316 Ultrapure water Closed-cell measurement Pt100 sensor</p>	
SPT01G	<p align="center">K=0.1 0.1µS/cm ... 500µS/cm 0...80°C 2-electrode cell in Platinum wire Glass probe material Pure water Pt100 sensor</p>	
SPT1G	<p align="center">K=1 10µS/cm ... 10mS/cm 0...80°C 2-electrode cell in Platinum wire Glass probe material General heavy duty use, me- dium conductivity Pt100 sensor</p>	
SPT10G	<p align="center">K=10 500µS/cm ... 200mS/cm 0...80°C 2-electrode cell in Platinum wire Glass probe material General heavy duty use, high conductivity Pt100 sensor</p>	

Conductivity probes with SICRAM module ⑦

ORDER CODE	MEASUREMENT RANGE	DIMENSIONS
SPT1GS	<p>K=1 $10\mu\text{S/cm} \dots 10\text{mS/cm}$ $0 \dots 80^\circ\text{C}$ 2-electrode cell in Platinum wire</p> <p>Glass probe material General heavy duty use, me- dium conductivity Pt100 sensor</p>	

TEMPERATURE PROBES

Temperature probes Pt100 using SICRAM module ⑤

Model	Type	Application range	Accuracy
TP87	Immersion	$-50^\circ\text{C} \dots +200^\circ\text{C}$	$\pm 0.25^\circ\text{C} (-50^\circ\text{C} \dots +200^\circ\text{C})$
TP472I.0	Immersion	$-50^\circ\text{C} \dots +400^\circ\text{C}$	$\pm 0.25^\circ\text{C} (-50^\circ\text{C} \dots +350^\circ\text{C})$ $\pm 0.4^\circ\text{C} (+350^\circ\text{C} \dots +400^\circ\text{C})$
TP473P.0	Penetration	$-50^\circ\text{C} \dots +400^\circ\text{C}$	$\pm 0.25^\circ\text{C} (-50^\circ\text{C} \dots +350^\circ\text{C})$ $\pm 0.4^\circ\text{C} (+350^\circ\text{C} \dots +400^\circ\text{C})$
TP474C.0	Contact	$-50^\circ\text{C} \dots +400^\circ\text{C}$	$\pm 0.3^\circ\text{C} (-50^\circ\text{C} \dots +350^\circ\text{C})$ $\pm 0.4^\circ\text{C} (+350^\circ\text{C} \dots +400^\circ\text{C})$
TP475A.0	Air	$-50^\circ\text{C} \dots +250^\circ\text{C}$	$\pm 0.3^\circ\text{C} (-50^\circ\text{C} \dots +250^\circ\text{C})$
TP472I.5	Immersion	$-50^\circ\text{C} \dots +400^\circ\text{C}$	$\pm 0.3^\circ\text{C} (-50^\circ\text{C} \dots +350^\circ\text{C})$ $\pm 0.4^\circ\text{C} (+350^\circ\text{C} \dots +400^\circ\text{C})$
TP472I.10	Immersion	$-50^\circ\text{C} \dots +400^\circ\text{C}$	$\pm 0.3^\circ\text{C} (-50^\circ\text{C} \dots +350^\circ\text{C})$ $\pm 0.4^\circ\text{C} (+350^\circ\text{C} \dots +400^\circ\text{C})$

Temperature drift @20°C

0.003%/°C

4 wire Pt100 and 2 wire Pt1000 probes without TP47 module (Input ⑤)

Model	Type	Application range	Accuracy
TP47.100	4 wire Pt100	$-50 \dots +200^\circ\text{C}$	Class A
TP47.1000	2 wire Pt1000	$-50 \dots +200^\circ\text{C}$	Class A
TP87.100	4 wire Pt100	$-50 \dots +200^\circ\text{C}$	Class A
TP87.1000	2 wire Pt1000	$-50 \dots +200^\circ\text{C}$	Class A

Temperature drift @20°C

0.005%/°C

TP47 Module for connection to the HD22... series of the following probes: direct 4 wire Pt100, 2 wire Pt1000, **without electronic amplification and linearization**. (The connection instructions are outlined on page 36).

ORDER CODES THE HD22... SERIES INSTRUMENTS

- HD2205.2** The kit is composed of: instrument HD2205.2, performs measurements of pH - redox - temperature, **datalogger**, stabilized power supply with $V_{in}=100-240V_{ac}/12V_{dc}-1A$ (SWD10), operating manual, case and DeltaLog11 software.
- HD2206.2** The kit is composed of: instrument HD2206.2, performs measurements of conductivity - resistivity - TDS - salinity - temperature, **datalogger**, stabilized power supply with $V_{in}=100-240V_{ac}/12V_{dc}-1A$ (SWD10), operating manual, case and DeltaLog11 software.
- HD2256.2** The kit is composed of: instrument HD2256.2, performs measurements of pH - redox - conductivity - resistivity - TDS - salinity - temperature, **datalogger**, stabilized power supply with $V_{in}=100-240V_{ac}/12V_{dc}-1A$ (SWD10), operating manual, case and DeltaLog11 software.

The pH/mV electrodes, conductivity probes, temperature probes, standard reference solutions for different measurement types, connection cables for pH electrodes with S7 connector, serial and USB cables for data download to PC or printer have to be ordered separately.

COMMON ACCESSORIES FOR THE HD22... SERIES INSTRUMENTS

- 9CPRS232** Connection cable with sub D 9-pole female connectors for RS232C.
- CP22** Connection cable USB 2.0 connector type A on one end, connector type B on the other end.
- DeltaLog11** Additional copy of the software for download and management of the data on PC using Windows 98 to XP operating systems.
- SWD10** Stabilized power supply at 100-240Vac/12Vdc-1A mains voltage.
- S'print-BT** Portable, serial input, 24 column thermal printer, 58mm paper width.
- HD22.2** Laboratory electrode holder composed of basis plate with incorporated magnetic stirrer, staff and replaceable electrode holder. Height max. 380mm. For $\varnothing 12$ mm electrodes.
- HD22.2.1** Power connection cable from a HD22xx.2 series instrument.
- HD22.3** Laboratory electrode holder with metal base. Electrode holder with flexible arm for free positioning. For $\varnothing 12$ mm electrodes.
- HD22BT** Bluetooth module for wireless data transmission from instrument to PC **The module installation is carried out exclusively by Delta Ohm, when placing the order**
- HD USB.KL1** USB/Bluetooth converter to connect to the PC for wireless connection of the instrument using the HD22BT module.
- TP47** Connector for connection of 4 wire Pt100 and 2 wire Pt1000 probes to the HD22... series, without electronic amplification and linearization.

**ACCESSORIES FOR THE HD2205.2 AND HD2256.2 INSTRUMENTS
WITH INPUT FOR pH MEASUREMENT**

pH ELECTRODES WITHOUT SICRAM MODULE (INPUTS ① AND ②)

KP20	Combined general use pH electrode, gel-filled, with screw connector S7, body in Epoxy.
KP30	Combined general use pH electrode, gel-filled, 1m cable with BNC, body in Epoxy.
KP 50	Combined pH electrode for general use, varnishes, emulsions, gel-filled, with screw connector S7, body in glass.
KP 61	Combined pH electrode, 3 diaphragms for milk, cream, etc. with screw connector S7, body in glass.
KP62	Combined pH electrode, 1 diaphragm for pure water, paints, etc. gel-filled, with screw connector S7, body in glass.
KP 63	Combined pH electrode for general use, varnishes, 1 m cable with BNC, KCl 3M electrolyte, body in glass.
KP 64	Combined pH electrode for water, varnishes, emulsions, etc. with screw connector S7, KCl 3M electrolyte, body in glass.
KP70	Combined pH electrode, micro Ø 6.5mm, gel-filled, for milk, bread, cheese, etc. with screw connector S7, body in glass.
KP80	Combined pointed pH electrode, gel-filled, with screw connector S7, body in glass.
CP	Extension cable 1.5m with BNC connectors on one side and S7 on the other side for electrode, without cable, with S7 connector.
CP5	Extension cable 5m with BNC connectors on one side and S7 on the other side for electrode, without cable, with S7 connector.
CE	Screw connector S7 for pH electrode.
BNC	Female BNC for electrode extension.

pH ELECTRODE WITH SICRAM MODULE (INPUTS ③ AND ④)

KP63TS	Combined pH/temperature electrode, Pt100 sensor, with SICRAM module, body in glass, Ag/AgCl sat KCl.
---------------	--

SICRAM MODULE WITH BNC INPUT FOR pH ELECTRODES (INPUTS ③ AND ④)

KP47	SICRAM module with BNC input for pH electrode.
-------------	--

ORP ELECTRODES (INPUTS ① AND ②)

- KP90** REDOX PLATINUM electrode for general use, with screw connector S7, KCl 3M electrolyte, body in glass.
- KP91** REDOX PLATINUM electrode for general non heavy duty use, gel-filled, 1m cable with BNC, body in Epoxy.

pH STANDARD SOLUTIONS

- HD8642** Buffer solution 4.01pH - 200cc.
- HD8672** Buffer solution 6.86pH - 200cc.
- HD8692** Buffer solution 9.18pH - 200cc.

REDOX STANDARD SOLUTIONS

- HDR220** Redox buffer solution 220mV 0.5 l.
- HDR468** Redox buffer solution 468mV 0.5 l.

ELECTROLYTE SOLUTIONS

- KCL 3M** 50ml ready solution for electrode refilling.

MAINTENANCE AND CLEANING

- HD62PT** Diaphragm cleaning solution (Tiourea in HCl) – 200ml.
- HD62PP** Diaphragm cleaning solution (Pepsina in HCl) – 200ml.
- HD62RF** Electrode regeneration solution (Fluorhydric Acid) – 100ml.
- HD62SC** Electrode preservation solution – 200ml.

**ACCESSORIES FOR THE HD2206.2 AND HD2256.2 INSTRUMENTS
WITH INPUT FOR CONDUCTIVITY MEASUREMENT**

CONDUCTIVITY AND COMBINED CONDUCTIVITY/TEMPERATURE PROBES

WITHOUT SICRAM MODULE (INPUT Ⓢ)

SP06T	Conductivity/temperature combined probe, 4-electrode cell in Platinum, body in POCAN. Cell constant K = 0.7. Measuring range 5µS/cm ...200mS/cm, 0...90°C.
SPT401.001	Conductivity/temperature combined probe, 2-electrode cell in AISI 316 steel. Cell constant K 0.01. Measuring range 0.04µS/cm ...20µS/cm, 0...120°C.
SPT01G	Conductivity/temperature combined probe 2-electrode cell in Platinum wire, body in glass. Cell constant K = 0.1. Measuring range 0.1µS/cm ...500µS/cm, 0...80°C.
SPT1G	Conductivity/temperature combined probe 2-electrode cell in Platinum wire, body in glass. Cell constant K = 1. Measuring range 10µS/cm ...10mS/cm, 0...80°C.
SPT10G	Conductivity/temperature combined probe 2-electrode cell in Platinum wire, body in glass. Cell constant K = 10. Measuring range 500µS/cm ...200mS/cm, 0...80°C.

CONDUCTIVITY/TEMPERATURE COMBINED PROBES WITH SICRAM MODULE (INPUT Ⓣ)

SPT1GS	Conductivity/temperature combined probe 2-electrode cell in Platinum wire, body in glass, with SICRAM module. Cell constant K = 1. Measuring range 10µS/cm ...10mS/cm, 0...80°C.
---------------	--

STANDARD CONDUCTIVITY CALIBRATION SOLUTIONS

HD8747	Standard calibration solution 0.001 mol/l equal to 147µS/cm @25°C - 200cc.
HD8714	Standard calibration solution 0.01 mol/l equal to 1413µS/cm @25°C - 200cc.
HD8712	Standard calibration solution 0.1 mol/l equal to 12880µS/cm @25°C - 200cc.
HD87111	Standard calibration solution 1 mol/l equal to 111800µS/cm @25°C - 200cc.

**ACCESSORIES FOR THE HD22... SERIES INSTRUMENTS
WITH INPUT FOR TEMPERATURE MEASUREMENT**

TEMPERATURE PROBES COMPLETE WITH SICRAM MODULE (INPUT ⑤)

TP87	Pt100 sensor immersion probe. Probe's stem Ø 3 mm, length 70mm. Cable length 1 metre.
TP472L.0	Pt100 sensor immersion probe. Stem Ø 3 mm, length 230 mm. Cable length 2 metres.
TP473P.0	Pt100 sensor penetration probe. Stem Ø 4 mm, length 150 mm. Cable length 2 metres.
TP474C.0	Pt100 sensor contact probe. Stem Ø 4 mm, length 230 mm, contact surface Ø 5 mm. Cable length 2 metres.
TP475A.0	Pt100 sensor air probe. Stem Ø 4 mm, length 230 mm. Cable length 2 metres.
TP472L.5	Pt100 sensor immersion probe. Stem Ø 6 mm, length 500 mm. Cable length 2 metres.
TP472L.10	Pt100 sensor immersion probe. Stem Ø 6 mm, length 1000 mm. Cable length 2 metres.

TEMPERATURE PROBES

COMPLETE WITH TP47 MODULE (INPUT ⑤)

TP47.100	Direct 4 wire Pt100 sensor immersion probe with connector. Probe's stem Ø 3 mm, length 230 mm. 4 wire connection cable with connector, length 2 metres.
TP47.1000	Pt1000 sensor immersion probe. Probe's stem Ø 3 mm, length 230 mm. 2 wire connection cable with connector, length 2 metres.
TP87.100	Pt100 sensor immersion probe. Probe's stem Ø 3 mm, length 70mm. Connection cable 4 wires with connector, length 1 metre.
TP87.1000	Pt1000 sensor immersion probe. Probe's stem Ø 3 mm, length 70mm. Connection cable 2 wires with connector, length 1 metre.

COMMON ACCESSORIES FOR THE HD22... SERIES INSTRUMENTS

TP47	Module for connection to the HD22... series of the following probes: direct 4 wire Pt100, 2 wire Pt1000, without electronic amplification and linearization. (The connection instructions are outlined on page 36).
-------------	--

TABLE OF CONTENTS

INTRODUCTION	6
DISPLAY DESCRIPTION	7
KEYBOARD DESCRIPTION	14
MENU DESCRIPTION	17
USER MANAGEMENT	21
Settings.....	21
Access modes.....	21
Functions reserved to the administrator	22
pH measurement	23
Automatic or manual pH compensation	24
pH electrode calibration	25
Calibration procedure.....	25
Temperature characteristics of Delta OHM standard solutions.....	27
Conductivity measurement	28
Automatic or manual temperature compensation for conductivity measurement	30
Resistivity, TDS and salinity measurements	31
Calibration of conductivity.....	31
Automatic calibration of conductivity using memorized standard solutions	31
Manual calibration of conductivity using not-memorized standard solutions.....	33
Table of standard solutions at 147 μ S/cm, 1413 μ S/cm, 12880 μ S/cm and 111800 μ S/cm	35
TEMPERATURE MEASUREMENT	36
How to measure	36
Instructions to connect the TP47 connector for Pt100 probes or Pt1000	37
Direct connection of the 4 wire Pt100 sensor to a DIN45326 connector	38
WARNINGS AND OPERATING INSTRUCTIONS ON THE TEMPERATURE SENSORS	39
INSTRUMENT STORAGE	39
pH AND CONDUCTIVITY MEASUREMENTS - MOST FREQUENT PROBLEMS, POSSIBLE CAUSES AND HANDLING	40
Instrument functioning	40
pH measurement	40
Conductivity measurement.....	41
INSTRUMENT SIGNALS AND FAULTS	42
SERIAL INTERFACE AND USB	43
CONNECTION TO A PC	46
Connection to the RS232C serial port.....	46
Connection to the USB 2.0 port	46
Bluetooth Connection	48
STORING AND TRANSFERRING DATA TO A PC	49
The Record Function.....	49
Clearing the Memory	50
The PRINT function	50
BACKUP BATTERY REPLACEMENT	52

FUNCTIONING NOTES AND OPERATING SECURITY.....	53
HD22.2 LABORATORY ELECTRODE HOLDER WITH IN-BUILT MAGNETIC STIRRER.....	54
HD22.3 LABORATORY ELECTRODE HOLDER.....	54
COMMON TECHNICAL CHARACTERISTICS OF THE HD22... SERIES.....	56
HD2205.2 TECHNICAL CHARACTERISTICS pH - mV - °C - °F MEASUREMENT.....	58
HD2206.2 TECHNICAL CHARACTERISTICS χ - Ω - TDS - NaCl - °C - °F MEASUREMENT.....	60
HD2256.2 TECHNICAL CHARACTERISTICS pH – mV - χ - Ω - TDS - NaCl - °C - °F MEASUREMENT.....	63
TECHNICAL DATA IN LINE PROBES FOR THE INSTRUMENTS OF THE SERIES HD22.....	66
HD2205.2 and HD2256.2 pH Electrodes ① ②.....	66
HD2205.2 and HD2256.2 Redox Electrodes ① ②.....	68
2 and 4 electrode conductivity probes for HD2206.2 and HD2256.2.....	69
Temperature probes.....	70
Temperature probes Pt100 using SICRAM module ⑤.....	70
4 wire Pt100 and 2 wire Pt1000 probes without TP47module (Input ⑤).....	70
ORDER CODES THE HD22... SERIES INSTRUMENTS.....	71
COMMON ACCESSORIES FOR THE HD22... SERIES INSTRUMENTS.....	71
ACCESSORIES FOR THE HD2205.2 AND HD2256.2 INSTRUMENTS WITH INPUT FOR pH MEASUREMENT.....	72
pH electrodes without SICRAM module (Inputs ① and ②).....	72
pH electrode with SICRAM module (Inputs ③ and ④).....	72
SICRAM module with BNC input for pH electrodes (Inputs ③ and ④).....	72
ACCESSORIES FOR THE HD2206.2 AND HD2256.2 INSTRUMENTS WITH INPUT FOR CONDUCTIVITY MEASUREMENT.....	74
ACCESSORIES FOR THE HD22... SERIES INSTRUMENTS WITH INPUT FOR TEMPERATURE MEASUREMENT.....	75

The electric and electronic devices with the following symbol



cannot be disposed in the public dumps.

According to the Directive UE 2002/96/EC, the European users of electric and electronic devices are allowed to give back to the Distributor or Manufacturer the used device at the time of purchasing a new one.

The illegal disposing of electric and electronic devices is punished by a pecuniary administrative penalty.

GARANZIA
GARANTIE



GUARANTEE
GARANTIA

Questo certificato deve accompagnare l'apparecchio spedito al centro assistenza.

IMPORTANTE: La garanzia è operante solo se il presente tagliando sarà compilato in tutte le sue parti.

This guarantee must be sent together with the instrument to our service centre.

N.B.: Guarantee is valid only if coupon has been correctly filled in all details.

Le certificat doit porter le cachet du revendeur et la date d'achat. A défaut, la garantie sera comptée à partir de la date de la sortie d'usine.

ATTENTION: Pour bénéficier de la garantie, le présent certificat doit obligatoirement accompagner l'appareil présumé défectueux.

Dieser Garantieschein muss der Spedition beigelegt werden, wenn das Gerät an das Kundendienstzentrum gesandt wird.

WICHTIG: Die Garantie ist nur gültig, wenn dieser Abschnitt bis ins Einzelne ausgefüllt ist.

Este certificado debe acompañar al aparato enviado al centro de asistencia.

IMPORTANTE: La garantía es válida solo si el presente cupón ha sido completado en su totalidad.

Instrument type **HD2205.2** **HD2206.2** **HD2256.2**

Serial number _____

RENEWALS

Date _____

Date _____

Inspector _____

Inspector _____

Date _____

Date _____

Inspector _____

Inspector _____

Date _____

Date _____

Inspector _____

Inspector _____



CE CONFORMITY	
Safety	EN61000-4-2, EN61010-1 LEVEL 3
Electrostatic discharge	EN61000-4-2 LEVEL 3
Electric fast transients	EN61000-4-4 LEVEL 3
Voltage variations	EN61000-4-11
Electromagnetic interference susceptibility	IEC1000-4-3
Electromagnetic interference emission	EN55020 class B