

Operating manual

Integrating Sound Level Meter
Spectrum Analyzer
HD2010UC/A



Companies / Brands of GHM

Members of GHM GROUP:

GREISINGER

HONSBURG

Martens

IMTRON

Delta OHM

VAL.CO

www.deltaohm.com

Keep for future reference.

TABLE OF CONTENTS

CONNECTORS FUNCTION	7
INTRODUCTION	8
HD2010UC/A Block Diagram	11
The Microphone	12
The Outdoor Microphone Unit HDWME	12
The Preamplifier.....	13
The Instrument	14
DESCRIPTION OF DISPLAY MODES	15
SLM (SOUND LEVEL METER MODE)	17
Display Description.....	17
Selecting Parameters	18
Back-Erase Function (data exclusion).....	18
TIME PROFILE MODE	19
Display Description.....	19
Using the Cursors	20
SPECTRUM MODE (SPECTRUM BY OCTAVE OR THIRD OCTAVE BANDS)	21
Display Description.....	22
Using the Cursors	22
STATISTICAL GRAPHS	23
LEVEL DISTRIBUTION OF PROBABILITIES.....	25
PERCENTILE LEVELS GRAPH.....	26
EVENT TRIGGER FUNCTION	27
INTEGRATION	29
PRINT AND MONITOR FUNCTIONS	31
THE RECORD FUNCTION	32
MANUAL AND AUTOMATIC SINGLE RECORDING	32
CONTINUOUS RECORDING.....	33
CONTINUOUS RECORDING OF REPORTS AND EVENTS GROUPS.....	34
DESCRIPTION OF THE MENU FUNCTIONS	37
INSTRUMENT.....	38
Identification	38
System.....	38
Input Output	39
Measurements	39
Sound Level Meter.....	40
Spectrum Analyzer.....	40
STATISTICAL ANALYZER	41
TRIGGER	41
RECORDING	41
Measurements	41
Report.....	42
Event	42
CALIBRATION	42
SEQUENCER	43
PROGRAMS	44
NAVIGATOR.....	44
CALIBRATION	47
Periodic calibration	49
Electric calibration	50
Acoustic calibration	52
Microphone replacement.....	55
Diagnostic check	55
REVERBERATION TIME MEASUREMENT.....	56

Instrumentation and measurement conditions	56
Measurement using a stationary noise.....	58
Measurement using an impulsive noise.....	59
Operating procedure for reverberation time measurement.....	60
FIRMWARE UPDATE.....	71
OPTIONS UPGRADE.....	71
BATTERY MANAGEMENT.....	72
INSTRUMENT STORAGE.....	74
SERIAL INTERFACE.....	75
COMMUNICATION PROTOCOL	77
SET Group (SETUP)	78
KEY GROUP.....	81
STT GROUP (STATUS)	82
DMP GROUP (DUMP).....	83
CONNECTION TO A MODEM.....	85
CONNECTION TO A PRINTER.....	86
CONNECTION TO A PC WITH USB INTERFACE.....	87
Verification of proper driver installation.....	87
HD2010MC MEMORY CARD READER	89
DESCRIPTION OF THE INTERFACE FOR MEMORY CARD HD2010MC	89
PREPARATION OF A NEW MEMORY CARD	89
CONNECTION OF HD2010MC TO THE SOUND LEVEL METER AND USE OF THE MEMORY CARD.....	90
FOR USING DATA DIRECTLY FROM PC.....	91
DATA TRANSFER FROM SOUND LEVEL METER TO MEMORY CARD	91
TECHNICAL SPECIFICATIONS.....	91
TECHNICAL SPECIFICATIONS	92
METROLOGICAL CHARACTERISTICS	93
ELECTRICAL CHARACTERISTICS	96
STATISTICAL ANALYSIS.....	97
SPECTRAL ANALYSIS.....	97
REVERBERATION TIME MEASUREMENT (OPTIONAL)	98
VISUALIZATION	98
STORAGE OF MEASUREMENTS	99
PROGRAMS	99
OTHER CHARACTERISTICS	100
REFERENCE STANDARDS	101
ITALIAN LAWS.....	101
ORDER CODES	102
WHAT SHALL I DO IF	105
MEASUREMENT PROCEDURE	105
STORAGE OF MEASUREMENTS	106
MEASUREMENT OF NOISE DOSE	107
STATISTICAL ANALYSIS.....	108
DATA PRINTING	108
TROUBLESHOOTING.....	109
RESTORING FACTORY CALIBRATION	109
RESTORING FACTORY CALIBRATION	109
MISCELLANEOUS PROBLEMS	110
KEYBOARD DESCRIPTION.....	111

ANNEX.....	118
A1. HD2010UC/A MEASURING PARAMETERS	118
ACOUSTIC DESCRIPTORS (GRAPHIC DISPLAY)	119
ACOUSTIC DESCRIPTORS THAT CAN BE STORED.....	119
A2. MEMORY CAPACITY DURING THE LOGGING FUNCTION	121
A3: THE SOUND	122
A4: SOUND LEVEL METER.....	124
Frequency Weighting	124
Spectral Analysis.....	124
Time constants and exponential weighting	125
Impulsive Noises	125
Equivalent Continuous Sound Pressure Level	126
Statistical Analysis	128
Noise Dose	129
Acoustic Field	129
Environmental influence	130
Precautions and general hints of use	130
Classification of acoustic signals	131
A5: ARCHITECTURAL AND BUILDING ACOUSTICS	134
A5.1 - Measurement of the sound absorption	136
A5.2 - Measurement of the airborne noise sound insulation	137
A5.3 - Measurement of the tapping noise	139
A6 - HDWME OUTDOOR PROTECTION – ASSEMBLY, DISASSEMBLY AND MAINTENANCE.....	141
A7: DEFINITIONS.....	148

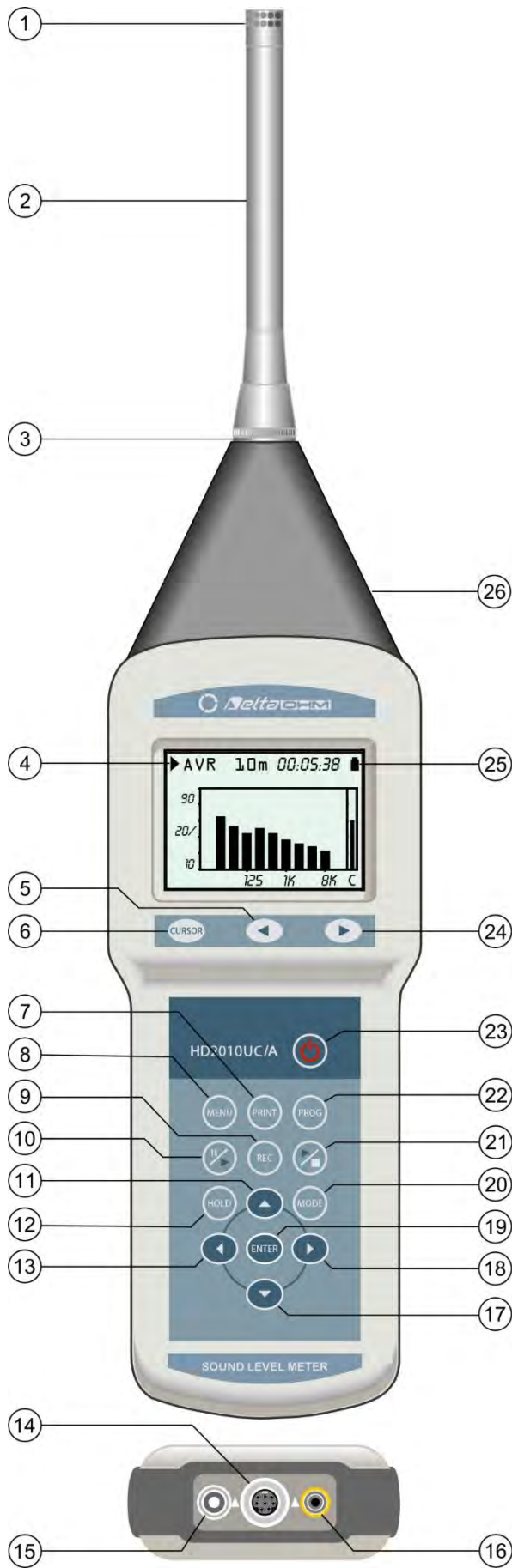

1. Microphone.
2. Preamplifier.
3. Preamplifier or extension cable connector.
4. Symbol showing measurement status: RUN, STOP, PAUSE, RECORDING or HOLD.
5. Keypad **LEFT** key: in graphic mode, it moves the selected cursor towards lower values.
6. Keypad **CURSOR** key: in graphic mode, it allows to select one or both of the two cursors.
7. **PRINT** key: transfers the displayed data to the serial port. When pressed for more than 3 seconds, it enables the continuous printing (Monitor). Monitoring will be stopped by pressing the key once more.
8. **MENU** key: it activates the different configuration menus of the instrument.
9. **REC** key (recording): combined with START/STOP/RESET, it activates data recording on memory. When pressed for at least 2 seconds, the displayed data can be stored in memory as a single record; alternatively, the Auto-Store mode can be activated.
10. **PAUSE/CONTINUE** key: pauses integrated measurements. From PAUSE mode, integrated measurements can be resumed by pressing the same key. In PAUSE mode, press START/STOP/RESET to reset measurements.
11. **UP** key: in the menu, it selects the previous line or increases the selected parameter. In graphic mode, it decreases the vertical scale levels; the graph is shifted upwards.
12. **HOLD** key: it temporarily stops display updating.
13. **LEFT** key: in the menu, it is used when editing parameters with attribute. In graphic mode, it reduces the vertical scale.
14. M12 connector for RS232C multi-standard serial port and USB.
15. Auxiliary power supply connector.
16. DC output connector (\varnothing 2.5mm jack).
17. **DOWN** key: in the menu, it selects the next line or decreases the selected parameter. In graphic mode, it increases the vertical scale levels; the graph is shifted downwards.
18. **RIGHT** key: in the menu, it is used when editing parameters with attribute. In graphic mode it extends the vertical scale.
19. **ENTER** key. It confirms entered data or edited parameters.
20. **MODE** key: selects in circular order the instrument's different view modes, from the display of 5 channels in numeric format, to the profile, to the octave and third octave spectrum ("Third Octave" option) and to the statistics analysis screens.
21. **START/STOP/RESET** key: when pressed in STOP mode, it starts the measurements (RUN mode). In RUN mode, it stops the measurements. When pressed in PAUSE mode, it resets the integrated measurements, such as Leq, SEL, MAX/MIN levels, etc.
22. **PROG** key: activates the program selection mode.
23. **ON/OFF** key: turns the instrument on and off.
24. Keypad **RIGHT** key: in graphic mode, it moves the selected cursor towards higher values.
25. Battery symbol: indicates the battery level. The more the symbol is empty, the more the battery has run down.
26. **LINE**: un-weighted output connector (\varnothing 3.5mm jack).

CONNECTORS FUNCTION

The instrument is equipped with five connectors: one in front, one to the side and three at the bottom. The figure on page 2 shows:

- n. 3 - 8-pole DIN connector for preamplifier or extension cable. The connector, located on the instrument front face, has a positioning notch and a screw ring nut to ensure proper locking.
- n.14 - M12 connector for RS232C multi-standard serial port and USB. For the connection to a COM port (RS232), you have to use the dedicated serial null-modem cable (code HD2110RS), fitted with a 9-pole female connector conforms to class 1 specifications according. As alternative the sound level meter can be connected to a PC USB port by using the dedicated cable (HD2110USB), fitted with type A USB connector.
- n.15 - Male connector for external power supply (\varnothing 5.5mm-2.1mm socket). It requires a 5...24 Vdc/500 mA power supply. The positive (pole) power supply must be connected to the central pin.
- n.16 - Jack (\varnothing 2.5mm) or the analogue (DC) A weighted output with FAST constant time updated 8 times/s.
- n.26 - Jack (\varnothing 3.5 mm) for the analogue (LINE) un-weighted output placed on the right side of the conical part/detail.

INTRODUCTION

HD2010UC/A is an integrating portable sound level meter performing either spectral or statistical analysis. The instrument has been designed combining maximum usage flexibility, cheapness, and simplicity of use. Attention has been paid to the possibility of adjusting the instrument to regulatory modifications, and to the necessity of meeting its users' needs of today and tomorrow. The HD2010UC/A can be integrated with other options to extend its application scope at any time; the firmware can be updated directly by the user by means of the supplied Noise Studio program. The HD2010UC/A conforms to IEC 61672-1 of 2002 and IEC 61672-1 ed. 2.0 of 2013, IEC 60651 and IEC 60804 specifications with class 2 or class 1 tolerances. The constant percentage bandwidth (CPB) filters meet IEC 61620 class 1 specifications.

The HD2010UC/A is an integrating sound level meter and analyzer suitable for the following applications:

- Assessment and monitoring of the environmental noise level,
- Spectral analysis by octave bands from 31.5Hz to 8kHz,
- Optional (HD2010.O1) spectral analysis by third octave bands from 25Hz to 12.5kHz,
- Statistical analysis with percentile levels calculation from L_1 to L_{99}
- Capture and analysis of sound events,
- Measurement at the workplace,
- Selection of personal protective equipment (SNR, HML and OBM methods),
- Soundproofing and acoustic treatment,
- Production quality control,
- Measurement of machine noise,
- Optional architectural and building acoustics measurements.

Using the HD2010UC/A sound level meter it's possible to log the noise time profile with parallel frequency weightings and time constants acquisition. The sound level meter , automatically stores noise analysis of multiple acoustic descriptors as a data recorder, with a storing capacity of more than 23 hours at the maximum temporal resolution. For long term noise monitoring, it's possible to record together, with a time period from 1 s to 1h, 5 programmable parameters, the average spectrum and complete statistical analysis: with the "Memory module" option HD2010.O0 (it doubles the standard memory capacity), the HD2020UC/A can store, with a time interval of 1min, the noise multi-parameter and statistical analysis for more than 10 days. For particular needs it's possible to increase even further the memory capacity using the HD2010MC module. This device is supplied with a 2GB SD memory card.

The HD2010UC/A has a versatile trigger function for the noise event capture, with the additional possibility to filter false events; this is made verifying that the noise event level variation has a certain duration. For each identified event, it's possible to record 5 integrated parameters (user defined), average spectra in octave and third octave bands and the noise levels probability distribution sampled during the specific event. The event parameters recording doesn't exclude the normal and interval standard storing. The event trigger function can be started also manually pressing a key on the keyboard.

The advanced functions of HD2010UC/A analyser, allow multi-parameters profile acquisition in parallel with reports sequences with dedicated parameters, average spectra and complete statistical analysis. Moreover, during recording, trigger function allows to identify noise events and to record 5 user defined parameters, average spectrum and statistical analysis, all integrated during the event duration.

During data-logging are available up to 9 different markers to highlight the occurrence of specific situations to be considered in the time history post processing phase.

A timer allows to schedule a delayed acquisition start.

Different recordings can be later recalled from internal memory and displayed on the graphical screen using the “Replay” function that shows the time history of recorded noise levels. The USB interface high transfer speed, combined with RS232 flexibility, allow fast data transfer from sound level meter internal memory to PC memory but also to control a modem or a printer. For example, in case the internal memory is not sufficient, that’s the case of long term monitoring, it’s possible to activate the “Monitor” function. Such function allows to transmit displayed data through the serial interface, recording them directly on PC memory.

The HD2010UC/A can be fully controlled via a PC using the multi-standard serial interface (RS232 and USB), using a dedicated communication protocol. Through RS232 serial interface it’s possible to connect the HD2010UC/A to a PC also by means of a modem.

Together with the logging of the overall noise level profiles, the spectral analysis is carried out in real time for octave bands and for third octave bands, as an option. The sound level meter calculates the spectrum of the sound signal twice a second and integrates it linearly for up to 99 hours. The average spectrum or the multi-spectrum profile starting from 1s, are displayed together with an A, C or Z wideband overall level; this allows a fast comparison between spectrum and overall level. Moreover the spectrum can be shown both as linear and as A or C frequency weighted, for a fast evaluation of the different spectral components audibility.

As a statistical analyser, the HD2010UC/A samples the sound signal 8 times per second with A-frequency weighting and FAST time constant, and analyses it statistically according to 0.5 dB classes. Statistical analysis is shown in a graphic form as probability distribution and cumulative distribution with percentile levels from L₁ to L₉₉.

For further analysis, the LINE un-weighted output allows to record the noise either on tape or directly on a PC equipped with a data acquisition card.

The calibration can be made either using an acoustic calibrator (type 1 or 2 according to IEC 60942) or the built-in reference generator. The electric calibration employs a special preamplifier and checks the sensitivity of the measuring channel, microphone included. A protected area in the non-volatile memory, reserved to factory calibration, is used as a reference in the user’s calibrations, allowing to keep instrument drifts under control and preventing the instrument from wrong calibrations.

The user can check on site the complete sound level meter’s functionality thanks to a diagnostic program.

The HD2010UC/A sound level meter can perform the measurements required to evaluate workers’ noise exposure (D.L. N.81/2008, UNI 9432/2011 and ISO 9612/ 2011 standards). According to UNI EN 458, the personal protective equipment can be selected through octave band spectrum analysis (OBM method) and a comparison of the A and C-weighted equivalent levels that can be measured simultaneously (SNR method). If an undesired sound event produces an over-load indication, or simply alters the result of an integration, its contribution can be excluded using the versatile Back-Erase function. The impulsivity of a noise source is easily evaluated (according to criteria defined in UNI 9432 standard) measuring the A weighted equivalent sound pressure level with Impulse time constant (LAeqI).

The *cyclic*, *fluctuating* and *impulsive* noise sources identification is simple thanks to the powerful recording functions of HD2010UC/A analyser which allows, using a single measurement setup, to solve the most of situations encountered in working environments. The combination of powerful measurement and recording functions of HD2010UC/A with the analysis functions of the post processing Noise Studio (supplied with all sound level meters) software module “Worker’s protection”, allows a fast and efficient management of noise measurements for health and safety evaluations in workplaces.

The HD2010UC/A sound level meter is suitable for sound level monitoring, acoustic mapping, and the assessment of the acoustic climate with capture and analysis of sound events. When measuring traffic noise near airports, railways and roads, the sound level meter can be used as a multi-parameter sound recorder, combining spectrum (option “Third octave” from 25Hz to 12.5KHz) and statistical analyser features. Remote electrical calibrations and diagnostic tests can be executed using its remote control functions.

The HD2010UC/A, sound level meter, with the “Third Octave” and “Reverberation Time” options, can perform all measurements prescribed by the regulations on building acoustics evaluation (ISO 140). The sound level meter powerful DSP calculates 32 spectra/second, and it can measure reverberation times both using the sound source interruption and the impulsive source integration technique according to UNI EN ISO 3382. The HD2010UC/A sound level meter analyses the noise level decays with the *Ordinary Least Squares* method, simultaneously both by octave from 125Hz to 4KHz and, if option HD2010.O1 is installed, by third octave bands from 100Hz to 12.5KHz according to *survey, engineering* and *precision* methods defined in UNI EN ISO 3382-1/2009 and 3382/2008.

The HD2010UC/A can be configured in accordance with different customers’ needs: the available options can be activated on the new instrument, as well as, later on, when requested by the user. The provided options are:

- **“Third Octave” option**

It adds a parallel bank of third octave filters from 25Hz to 12.5 kHz in class 1, according to IEC 61260. The filter bank works in parallel to all other measurements. The audibility of the different spectrum components can be evaluated applying A or C frequency weightings or thanks to the isophone (equal loudness level) curve calculation function of Noise Studio, a program supplied with the instrument.

- **“Reverberation Time” option**

Through this option the HD2010UC/A can carry out reverberation time measurements according to the techniques of the interruption of the sound source and of the impulsive source according to EN ISO 3382-2/2008 requirements. This measurement is made simultaneously for octave band from 125 Hz to 8 kHz and optionally for third octave band from 100 Hz to 10 kHz. The sampling interval equals 1/32s and the calculation of EDT, T10, T20 and T30 reverberation times is made automatically for all bands.

HD2010UC/A BLOCK DIAGRAM

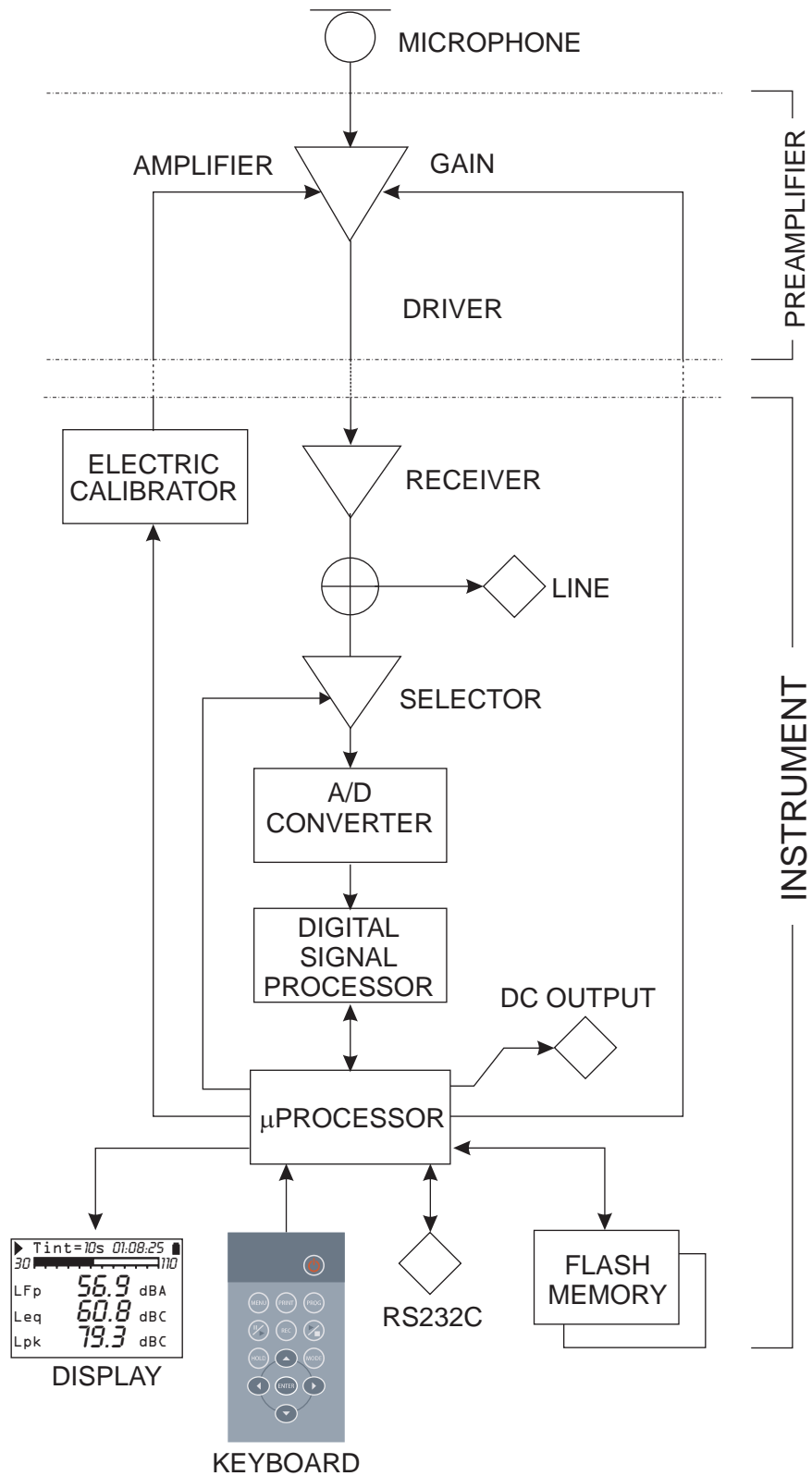

The block diagram shows the main elements of the HD2010UC/A sound level meter.

THE MICROPHONE

The UC52 condenser microphone is pre-polarized (electret) and has a ½” standard diameter. The frequency response in free field is flat from 20Hz to 16kHz in type 1 HD2010UC/A version (UC52/1). Microphones used for type 2 precision sound level meter versions have a flat frequency response from 25Hz to 10KHz.

THE OUTDOOR MICROPHONE UNIT HDWME

The microphone unit HDWME is suitable for long term outdoor noise measurements, including from fixed unattended station. The unit is adequately protected from rain and wind; the heated preamplifier allows performing measurements within a wide weather condition range.



The special preamplifier is fitted with a calibration circuit that uses a charge partition technique in order to calibrate the unit, inclusive of the microphone capsule. The output driver allows guiding cables up to 10m in length, without important losses.

HDWME unit must be positioned in vertical position to fulfil correctly its function as weather protection. Used in this way it can measure both community and aircraft noise (90° and 0°). Delta Ohm sound level meters apply spectral corrections to measurements in order to comply with IEC 61672 type 1 and type 2 tolerances.

Installation and uninstallation procedure is very easy; in this way periodical acoustic verification (using a standard ½ calibrator) of the microphone is as simple as for a standard measurement microphone.

The unit is composed of a central body plus the following components:

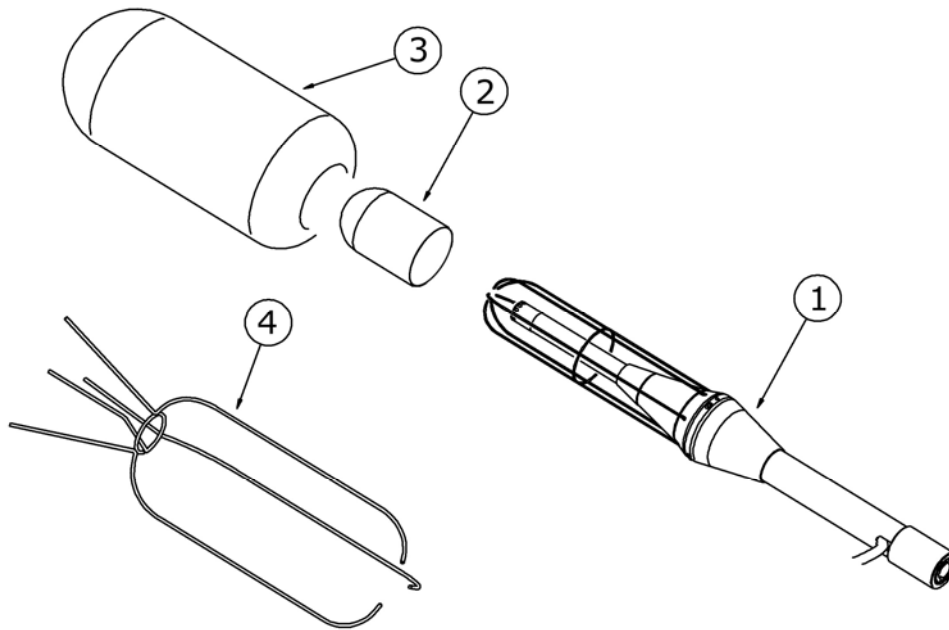

- **HDSAV3:** wind-screen (3)
- **HDWME1:** ant-bird spike (4)
- **HDWME2:** rain shield (2)
- **HDWME3:** stainless steel support (1)
- **Microphonic capsule** with optimized free field correction
- **Microphone preamplifier:** HD2010PNE2W: heated preamplifier for UC52 microphone including CTC calibrator and driver for up to 10m extension cable.
- **Extension cable** standard 5m length (10m on request).

For detailed information on the use of HDWME unit, please refer to the specific part of this manual on page 47; for information on assembling and disassembling the unit please refer to appendix on page 141.

THE PREAMPLIFIER

The preamplifier amplifies the weak signal provided by the microphone. It has a gain selectable between 0 and 20 dB and is supplied with a charge partition calibration device which allows to measure the frequency response of the whole amplification chain, microphone included as described on page 47).

The output driver allows transmitting the microphone signal via a cable to a distance up to 10m. The preamplifier of HD2010UC/A together with UC52 microphone can measure signals up to 140 dB with a frequency response (excluding microphone) up to 40kHz

The following models are available:

- **HD2010PNE2:** connector for ½" UC52 microphone and driver for up to 10m extension cables. This preamplifier, supplied with CTC electric calibration device, can be directly plugged into the HD2010UC/A sound level meter or connected via extension cable (up to 10mt).
- **HD2010PNE2W:** heated preamplifier with connector for ½" UC52 microphone and driver for extension cables. This preamplifier, supplied with CTC calibration device, can be connected to

sound level meters using the 5m supplied extension cable (10m as option).

- **HD2010PNE4:** preamplifier for MC24E ¼” microphone. Equipped with CTC calibration device for electric calibration and driver for cable up to 100m. Requires the HDP079A02 microphone adapter.
- **HD2010PNE4H:** preamplifier for MC24EH ¼” microphone. Equipped with CTC calibration device for electric calibration and driver for cable up to 100m. Requires the HDP079A02 microphone adapter.

THE INSTRUMENT

The preamplifier signal comes to the instrument receiver and its output is sent to the LINE connector and to the A/D converter input.

The A/D converts the analogue signal into the numeric format at 20 bits. The measurement dynamics, exceeding 140 dB, is divided into 5 ranges using a variable gain amplifier with steps of 10 dB, between 0 dB and 20 dB, positioned at the input.

Then the digitalized signal reaches the DSP for processing.

The levels either wideband (A, C and Z) or with constant percentage bandwidth (both octave and third octave) are calculated in parallel in the DSP. Peak (C and Z) levels are also calculated. The levels calculated by the DSP are transmitted to the microprocessor for further processing, ready to be displayed, stored and printed.

The microprocessor controls all the instrument processes: management of the electrical calibrator, Flash memory, display, keyboard and multi-standard serial interface (RS232 and USB).

The microprocessor also supplies the electrical signal corresponding to the A weighted instant level with FAST time constant, sent to DC output.

DESCRIPTION OF DISPLAY MODES

The HD2010UC/A measures simultaneously 3 selectable parameters (statistic ones too) and displays them at a fixed frequency corresponding to 2 measurements/s; simultaneously measures the A weighted sound pressure level with FAST time constant and displays it at 8 samples/s. It calculates also the spectra by octave bands and by third octave bands (when the “Third Octave” option is active), with a maximum frequency of 2 spectra/s. As a statistical analyser, it calculates the probability and the cumulative distribution. To be able to display all these data, the HD2010UC/A, provides 6 different display modes as shown in the figures below.

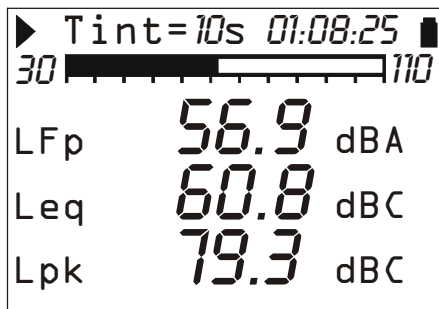

Fig. 1 - SLM

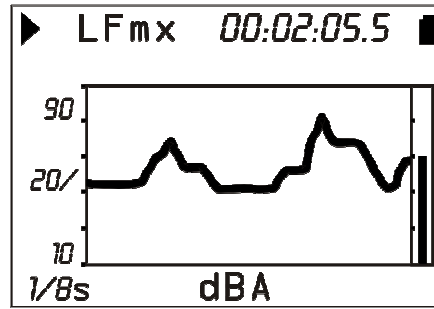

Fig. 2 - Time Profile

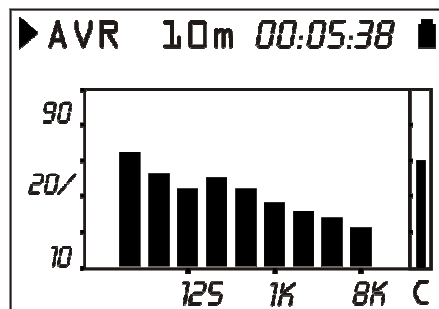

Fig. 3 - Octave

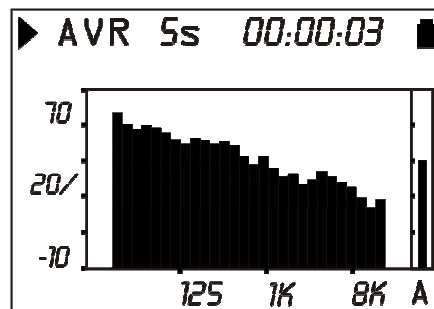

Fig. 4 - Third Octave

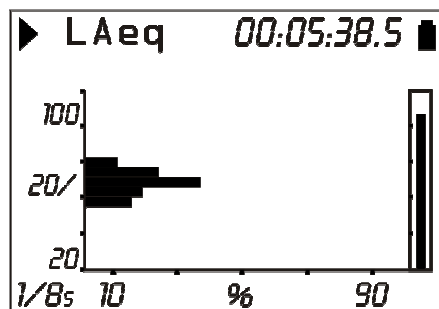

Fig. 5 – Probability distribution

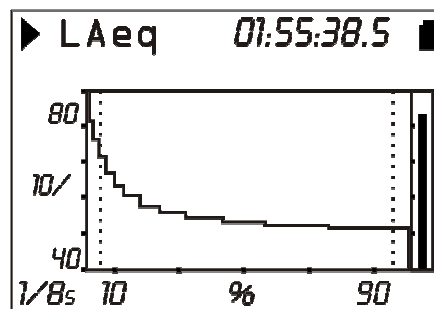

Fig. 6 – Percentiles levels

Press **MODE** at any time to jump from a screen page to the next one. The display will show: first the **SLM** screen with 3 measuring parameters in numeric format, the **Profile** screen of the A weighted sound pressure level with FAST time constant (L_{AFp}), then the **Octave** screen with the octave spectra from 31.5 Hz to 8 kHz and, (if the “Third Octave” option is active) the **third octave spectra** from 25Hz to 12.5 kHz, the **probability distribution** and the **percentile levels** screens. . Upon power on, the sound level meter displays the SLM screen.

Display of Octave and Third Octave display can be disabled using the specific parameters in the menu (Menu >> Statistic Analyser >> Display...). Also the Probability and Percentiles screens can be disabled, using parameter Menu >> Statistic Analyser >> Statistics Display (please see paragraph “DESCRIPTION OF MENU FUNCTIONS” on page 37)

Some display indications are common to all display modes; they are (see picture):

- Measurement status indicator
- Overload/Under-range indicator
- Battery level indicator

The first symbol in the left corner at the top shows the measurement status of the sound level meter.

- **RUN**: the instrument is measuring.
- **PAUSE**: the calculation of integrated measurements and the recording of measurement have been suspended. Instantaneous parameters are still being measured and displayed.
- **REC**: the instrument is measuring and recording.
- **STOP**: the instrument is not making any measurement.
- **HOLD**: the calculation of integrated measurements has come to the end of the set integration interval, or HOLD was pressed.
- **P (Print)**: indicates that printing is in progress.
- **M (Monitor)**: indicates (flashing) that continuous data printing has been started.
- **R (Replay)**: appears (flashing) when the “Memory Navigator” program is in use, to view a file saved in the instrument memory (see page 44).

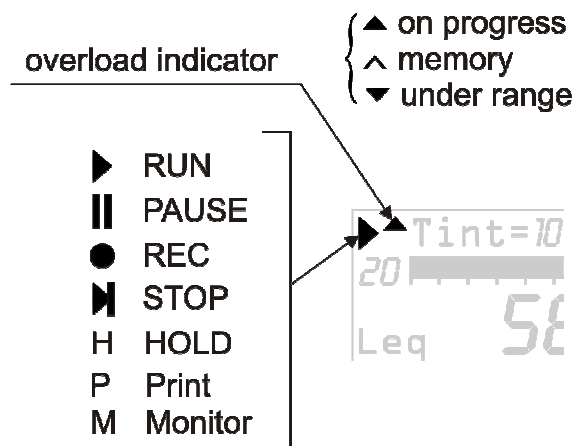

Just on the right of the symbol indicating the logging mode, there is the symbol showing a possible **overload** or under-range. An arrow directed upwards indicates that the input level has exceeded the maximum measurable level, while an arrow directed downwards indicates that the input level is lower than the minimum measurable level.

The maximum measurable level corresponding to the selected measurement range is given in the technical specifications (see page 92). The minimum measurable level is 80 dB lower than the maximum one. The noise levels for each frequency weighting are listed in the technical specifications. Using an appropriate parameter (MENU >> Instrument >> Measurement >> Overload Level) you can program the maximum measurable limit at lower levels (see page 92).

An empty arrow indicates that the limit has been exceeded, while a full arrow indicates that the overload is in progress.

The **integration time Tint**, programmable between 1s and 99h, is displayed to the right of the overload indicator.

In the right corner at the top, there is the **battery symbol**. The more the symbol is empty, the more the battery has run down. When the instrument autonomy reaches 10%, corresponding to about 30 minutes, the battery symbol will start flashing. A protection device prevents the instrument from making measurements with insufficient battery levels and automatically switches off the instrument when the battery level is at the minimum.

The battery level, expressed in percentage, is visible in the menu main screen page and in the program page; press MENU and PROG to access them. To jump back to the measurement screen, press MENU and PROG again.

Pressing **ENTER**, you will select in sequence the parameters relevant to the displayed page. While the selected parameter flashes, use UP and DOWN to change it.

In graphic display mode, use the UP, DOWN, LEFT and RIGHT keys to change the vertical scale parameters. The LEFT and RIGHT keys reduce and expand the vertical scale, while the UP and DOWN keys decrease and increase the levels of the vertical scale; the graph is so shifted upwards or downwards, respectively.

SLM (SOUND LEVEL METER MODE)

This is the display mode upon power on.

Three parameters (selectable among the following ones) can be displayed simultaneously:

- *Instantaneous* acoustic descriptors such as L_p , L_{eq} (Short) and L_{pk} . The instantaneous pressure level is displayed as the maximum level reached every 0.5s.
- *Integrated* acoustic parameters with wideband frequency weightings, such as L_{pmax} , L_{eq} , L_{leq} and L_{pkmax} , updated every 0.5s.
- Percentile levels selectable between L_1 ad L_{99} .
- Sound exposure level.
- Daily personal exposure level.
- Dose and daily Dose with programmable Exchange Rate, Criterion and Threshold Levels.
- Overload Time (in %).

The display is updated every 0.5 seconds.

The data recording depends on the activation or not of the **Auto-Store** function change the recording functioning as described in the table below.

Auto-Store: OFF	Auto-Store: ON
Recording twice a second of the 3 parameters and 8 times a second of LAF. Automatic Stop at the end of the set integration interval.	Automatic recording of SLM page, together with OCTAVE and (as an option) THIRD OCTAVE, at the end of the set integration interval.

DISPLAY DESCRIPTION

Left at the top of the display there are the recording status symbol and the overload or under-range indicator (described at the beginning of this chapter). In the midst there is the integration interval and on the right the acquisition time (hours:minutes:seconds). The battery symbol is in the right corner, indicating battery level.

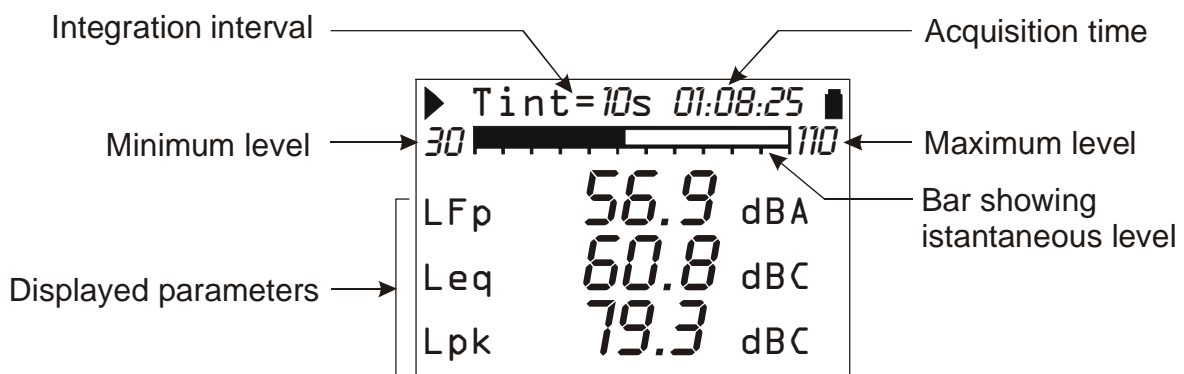

The "analogue bar" shows the **unweighted** sound pressure instantaneous level in an 80 dB interval.

Three measuring parameters are displayed under the analogue bar. All displayed parameters can be freely selectable among the available ones. There are no restrictions in the selection of frequency weightings. Measuring parameters are displayed with a shortened label, followed by the numerical value, by the unit of measurement, and, when necessary, by the frequency weighting. The correspondence between the label and the effective parameter is to be found on page 118.

Integrated parameters like Leq (and Lmax or Lmin), which imply the accumulation of the sampled sound levels, are displayed with a series of dashes (- - -) until the level remains lower than the minimum measurable level.

Before starting a new logging, the sound level meter automatically resets all measurements.

With the *Continuous Recording* function, a series of values is stored every 0.5s together with the parameter displayed in the PROFILE screen, which corresponds to the A weighted sound pressure level with FAST time constant, computed 8 times a second. Each sample corresponds to the highest sound level (L_{AFmx}) calculated every 0.125s on the level measured every 7.8ms.

SELECTING PARAMETERS

Some measuring parameters (integration interval, measuring range and the 3 parameters) can be changed directly via the SLM screen.

Pressing ENTER you choose the different parameters in sequence. While the selected parameter flashes, you can change it with the UP and DOWN keys.

If a parameter with attribute is selected, like, for example, LFp (FAST weighted pressure level), the relative frequency weighting will also flash (A in the example in the figure). In this case, pressing UP and DOWN, you can modify the selected parameter without changing the attribute; for example, if you press DOWN, you can go from LFp A weighted to LSp A weighted. Pressing RIGHT you'll jump to the attribute selection, which will be the only one to flash. Use then the UP and DOWN keys to change the attribute. For example, if you press UP, you can go from A weighted LSp to Z weighted LSp.

Parameters can be modified only when the instrument is in STOP mode: if you try to make changes to any of the parameters while the instrument is in a status other than STOP, you will be asked to stop the measurement in progress: pressing YES will stop recording and will allow you to go on modifying parameters; pressing NO recording will continue without interruption.

The above settings can be made through the instrument configuration menus. See a detailed description on page 34.

BACK-ERASE FUNCTION (DATA EXCLUSION)

To stop a measurement in progress when recording, press the PAUSE/CONTINUE key. All data logged until the moment key was pressed are used for calculation of integrated parameters. However, there are some cases when it is useful to clear the measurements recorded just before pressing PAUSE, for example, because they were caused by unexpected events and not characterizing the sound being examined.

During measurement, press PAUSE/CONTINUE: integrated measurements update will be interrupted. At this point, press the LEFT arrow to delete the last recorded data.

The integration time value will be temporarily replaced by the word ERASE followed by the time interval (in seconds) to be deleted. Use the LEFT and RIGHT keys to increase or decrease the erase interval. Displayed integrated parameters change accordingly, allowing to choose the erase time depending on the effective need. When pressing PAUSE/CONTINUE again, measurement will start again and the integrated parameters will have been removed from the selected interval.

The erase maximum time, divided into 5 steps, is set from menu: MENU >> Instrument >> Measurement >> Max Back-Erase. Settable values are: 5, 10, 30 or 60 seconds, with 1s, 2s, 6s or 12s steps, respectively.

TIME PROFILE MODE

This display mode presents the time profile of the A weighted sound pressure level with FAST time constant (L_{AFp}). The integration time is equal to $1/8s$ and the last 100 measured samples are displayed.

The HD2010UC/A sound level meter calculates the sound level 128 times per second (with a time period of 7.8ms) and displays the maximum level at intervals equal to 125ms.

Pressing HOLD, the display update will be stopped; however, the instrument continues measuring and pressing HOLD again will restart display updating.

The HOLD status does not affect either *Monitor* (continuous printing) or recording operations. When the continuous recording is activated, the integration time acts like a timer for data acquisition, stopping automatically the measurement when the time is elapsed.

This screen-page is not recorded in the Auto-Store mode.

DISPLAY DESCRIPTION

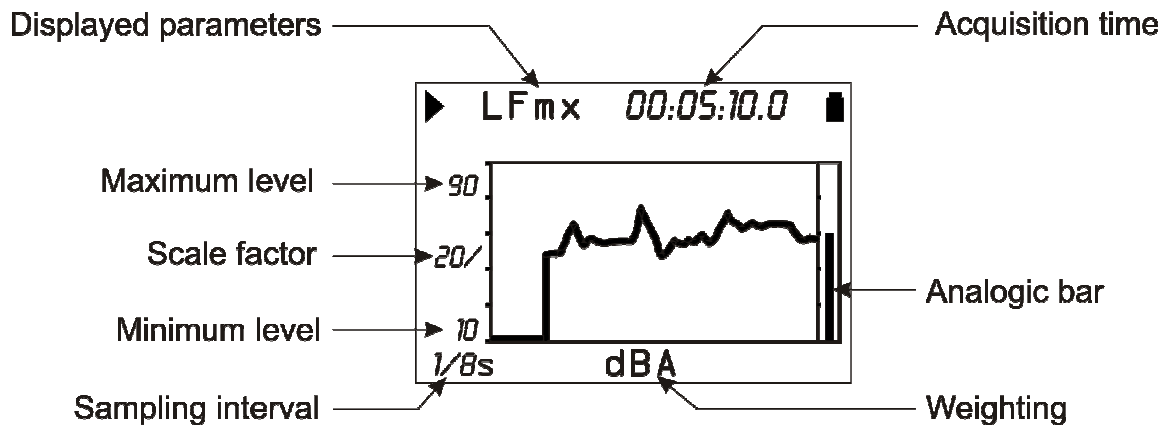

Fig. 7 - Description of the Profile mode display

The Fig. 7 presents the time profile of the A weighted sound pressure level with FAST time constant.

The integration interval is shown in the left corner at the bottom of the display. Always at the bottom, in the centre, the display shows the measurement unit and the frequency weighting of the measuring parameter

The amplitude of the vertical scale of the displayed graph corresponds to 5 divisions. The amplitude of each division is called “scale factor” of the graph and appears in the middle of the vertical axis.

Using the RIGHT (zoom +) and LEFT (zoom -) keys, this parameter is selectable in real time among 20dB, 10dB or 5dB by division.

Use the UP and DOWN arrows to set the graph full scale with steps equal to the selected scale factor, starting from the instrument full scale¹. In this way, the graph can be shifted UP or DOWN, depending on the key you have pressed.

An “analogue” bar indicator on the display right side provides the **unweighted** instantaneous level of the input sound pressure level, as for the SLM mode bar.

During *Recording* mode, 4 values of the L_{AFp} level are stored every 0.5s together with the SLM screen sound levels. Likewise, when the *Monitor* function is enabled, 4 values are sent to the interface every 0.5s.

The integration mode do not influence this screen recording functioning.

¹ The instrument full scale is determined by the selection of the input gain by choosing from the menu: MENU >> Instrument >> Measurements >> Input gain.

The sound level displayed on this screen can be used as source for the event trigger (see paragraph “EVENT TRIGGER FUNCTION” on pag. 27).

USING THE CURSORS

To activate cursors on the graph, press CURSOR on the keypad. If you press CURSOR repeatedly, either L₁ or L₂ cursor, or both ΔL cursors in “tracking” will be activated in succession: the selected cursor will flash. Use the LEFT and RIGHT arrows on the keypad to move the selected cursor on the graph.

The second line at the top of the display shows the level of the measuring parameter and the time indicated by the active cursor or the time interval and the L₁-L₂ level difference between the two cursors when they are both active.

The parameter level being lower than the minimum measurable level is indicated by a series of dashes (- - - -).

Cursors will be disabled pressing the CURSOR key again.

SPECTRUM MODE (SPECTRUM BY OCTAVE OR THIRD OCTAVE BANDS)

The **spectrum analyser** operation mode allows the visualisation of frequency spectrum by octave bands from 31.5Hz up to 8kHz and, if the “Third Octave” option is active, also by third octave bands from 25Hz to 12.5kHz. Spectral analysis is carried out and eventually recorded without any frequency weighting (Z) while the spectrum display can be also A or C weighted, for a fast evaluation of spectral components audibility.

The spectrum by octave bands or by third octave bands is combined, for possible comparisons, with a wideband level that might be A, C or Z weighted, as programmed.

The average spectrum (**AVR**) is linearly integrated band by band throughout the integration time (from 1s to 99h) shared with the SLM mode.

The instrument will automatically switch into the HOLD mode when reaching the set integration time, allowing to check the result and eventually print or store it. Press HOLD to continue with the display update.

If the continuous recording is activated (pressing at the same time REC and START keys), the integration time will act like a timer, stopping automatically the measurement when Tint is elapsed.

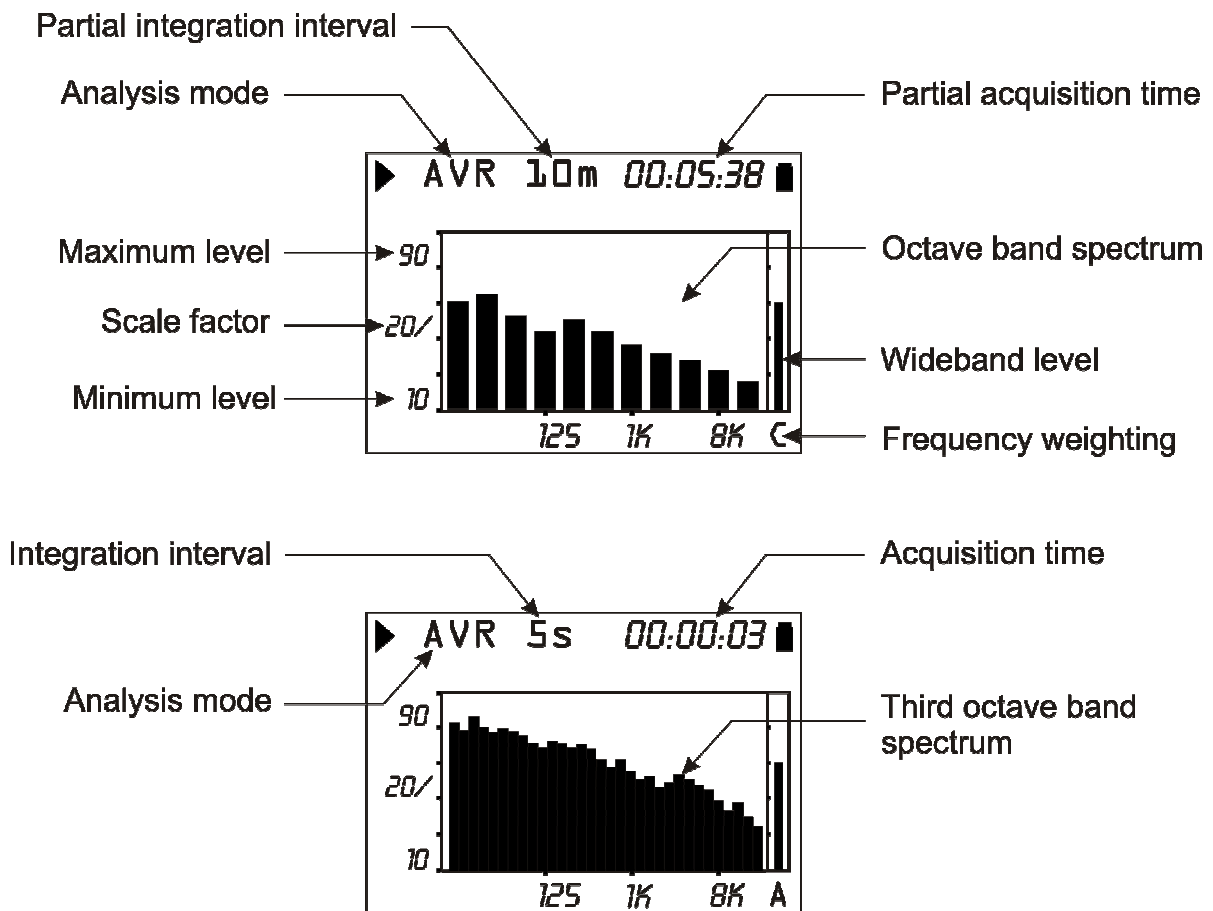

Spectral analysis, normally frequency unweighted (Z), can be carried out applying A or C frequency networks. The A or C frequency weighted analysis is used to evaluate audibility of different spectral components.

Some parameters can be changed without accessing the menus, but simply using the ENTER, UP, DOWN, LEFT and RIGHT keys: pressing several times the ENTER key, can be selected sequentially the graph vertical scale, the integration time, the spectra frequency weighting A, C or Z and the wideband auxiliary weighting (for more details, see "Selecting Parameters " on page 18).

In this display mode, the Monitor function works as in the SLM mode while the continuous recording function is not available in this display mode. However, if you press REC and hold it down for at least 2 seconds, the spectrum currently displayed can be recorded at any time.

The Auto-Store function changes the recording functioning as described in the table below.

Auto-Store: OFF	Auto-Store: ON
No recording.	Auto-Store of OCTAVE and, as an option, THIRD OCTAVE (together with SLM) at the end of the programmed integration interval.

DISPLAY DESCRIPTION

The display upper line shows, after the recording status symbol and the overload indicator, the graph updating mode (AVR), the integration interval (shared with the SLM display mode) and, on the right, the recording time.

The values on the left side of the graph are: the full scale, the scale factor and the scale beginning. The amplitude of the vertical scale of the displayed graph corresponds to 5 divisions. The amplitude of each division is called “scale factor” of the graph and appears in the middle of the vertical axis.

Using the RIGHT (zoom +) and LEFT (zoom -) keys, this parameter is selectable in real time among 20dB, 10dB or 5dB by division.

Use the UP and DOWN arrows to set the graph full scale with steps equal to the selected scale factor, starting from the instrument full scale². In this way, the graph can be shifted UP or DOWN according to the pressed key.

A bar on the display right side shows the wideband level, weighted Z, C or A, as selected. The applied frequency weighting is shown under the bar.

In the lower left part of the screen it's shown the spectrum frequency weighting (Z, C or A).

USING THE CURSORS

To activate cursors on the graph, press CURSOR on the keypad. If you press CURSOR repeatedly, either L₁ or L₂ cursor, or both Δ L cursors in “tracking” will be activated in succession: the selected cursor will flash. Use the LEFT and RIGHT arrows on the keypad to move the selected cursor on the graph.

The display second line shows level and central frequency of the filter indicated by the active cursor or the level difference between the two cursors when they are both active.

The level is indicated in dB for un-weighted spectra or in dBA or dBC for A and C weighted spectra respectively.

In the octave and third octave spectrum mode, cursors can be also positioned on the bar representing the wideband channel.

Filters having a level lower than the minimum measurable are indicated by the cursor with a series of dashes (- - - -).

² The instrument full scale is determined by the selection of the input gain by choosing from the menu: MENU >> Instrument >> Input gain.

STATISTICAL GRAPHS

The functioning mode with **advanced statistical analyzer** allows analyses on the sound pressure level with FAST time constant (sampled 8 times per second) or short equivalent level (integrated every 0.125s) or peak level (calculated twice per second) with any frequency weighting (only C or Z for peak level).

The statistical analysis is done with 0.5dB classes for sound levels from 21dB to 140dB and provides graphic display of the sound level distribution of probabilities and percentile levels. The graphs can be enabled in Menu >> Statistical Analyzer >> Display Statistics. Disabling the displays does not influence the programmable L1–L4 percentile level calculation.

The following figure shows the level **distribution of probabilities** on the 6-minute measurement of the noise issued by a climatic room. During measurement an acoustic calibrator was switched on for about 2 minutes near the microphone.

The distribution of probabilities shows the different “population” of the examined noise clearly. From lower levels, the first peak (about 63dBA) reflects the room background noise caused by the ventilation system. The second peak (about 65dB) concerns the cooling compressor activation. The third peak (about 69dB) is the tone issued by the calibrator.

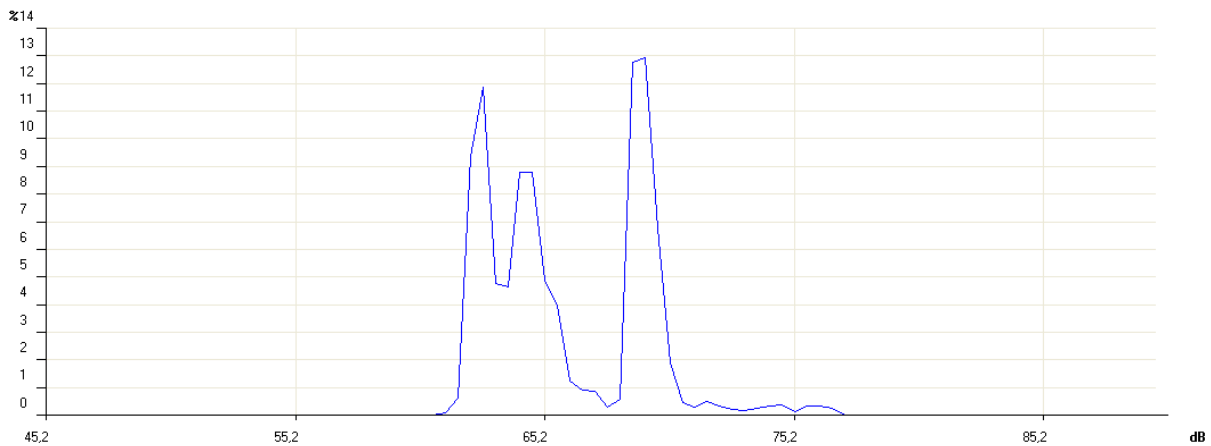

In the following figure the **cumulative distribution** for the same sample above can be seen. The cumulative distribution is built from the 100% of the levels under the measured minimum, and subtracting the probability of each you get 0 for the levels over the measured maximum.

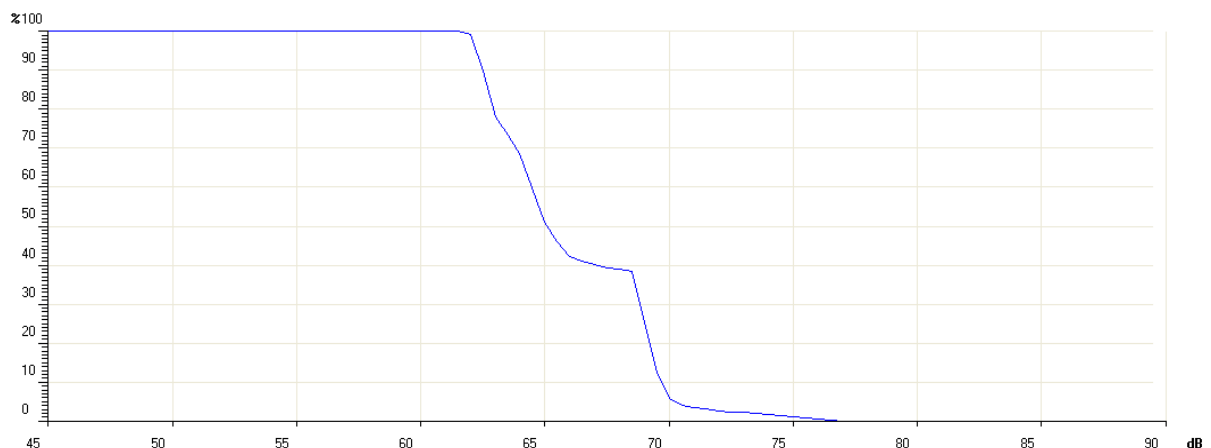

The *percentile levels* are calculated interpolating the cumulative distribution.

The statistical analyzer resets the classes at the beginning of measurement and it will continue accumulating the statistic until the end of the measurement. When the continuous recording is activated, the integration time acts like a timer for data acquisition, stopping automatically the measurement when the time is elapsed. When the *report* recording is active, the statistical graphs are cleared at the beginning of every interval set.

Statistical analysis is shown with two different graphical screens: the probability distribution and percentile levels graph.

LEVEL DISTRIBUTION OF PROBABILITIES

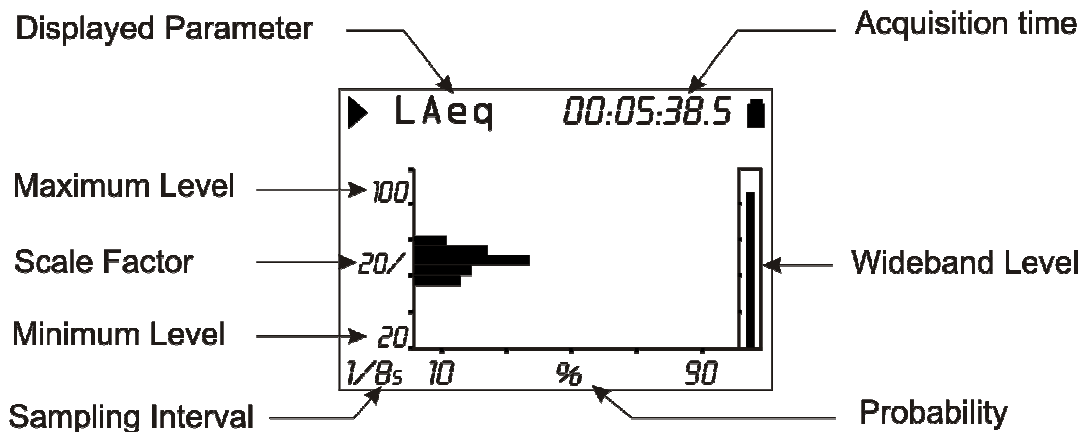

Fig. 8 - Description of the distribution of probabilities display

The figure shows the distribution of probabilities of the A weighted equivalent level with a 0.125s sampling interval. The vertical axis shows the sound levels in decibels and the probabilities are on the horizontal axis.

The display shows the sampling interval in the left lower corner, and the chosen measurement parameter for the statistical analysis in the first line on the right of the status indicator and possible overload indicator.

The amplitude of the vertical scale of the displayed graph corresponds to 5 divisions. The amplitude of each division is called “scale factor” of the graph and appears in the middle of the vertical axis. This parameter is selectable in real time among 20dB, 10dB or 5dB by division. These correspond to the 2dB, 1dB or 0.5dB classes in the graph. The scale factor can be set using the RIGHT (zoom +) and LEFT (zoom -) keys.

Use the UP and DOWN arrows to set the graph full scale with steps equal to the selected scale factor. In this way, the graph can be shifted UP or DOWN according to the pressed key.

An “analogue” bar indicator on the display right side provides the **un-weighted** instantaneous level of the input sound pressure level, as for the SLM mode bar.

The parameter chosen for statistical analysis can be changed without accessing the menus, but simply using the ENTER, UP, DOWN, LEFT and RIGHT keys (for more details, see "Selecting Parameters" on page 18).

Using the Cursors

To activate cursors on the graph, press CURSOR on the keypad. If you press CURSOR repeatedly, either L1 or L2 cursor, or both ΔL cursors in “tracking” will be activated in succession: the selected cursor will flash. Use the LEFT and RIGHT arrows on the keypad to move the selected cursor on the graph.

The second line at the top of the display shows the level and central frequency of the class and the relevant probability indicated by the active cursor, or the probability for the levels in the interval between the two cursors when they are both active.

Press CURSOR again to disable the cursors.

PERCENTILE LEVELS GRAPH

The graphic display is available for the sound level distribution of probabilities and also for the percentile levels.

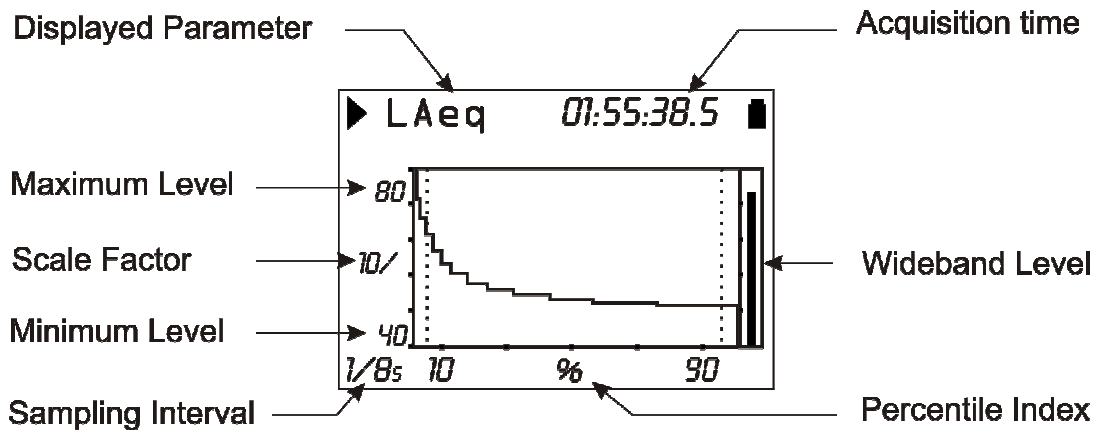

Fig. 9 - Description of the percentile levels display

The figure shows the percentile levels graph corresponding to the distribution of probabilities shown in the above paragraph.

From the sound level distribution of probabilities you can calculate the *cumulative distribution of probabilities* on the same classes. The cumulative distribution is equal to 100% for the classes with levels under the measured minimum, and 0% for the classes with levels over the measured maximum. From the minimum measured level class, the cumulative distribution decreases for the relevant probability of each class until the class corresponding to the maximum measured level, where it becomes zero. The $L_1 - L_{99}$ percentile levels are calculated interpolating the cumulative distribution of probabilities.

The vertical axis shows the sound levels in decibels and the percentile index is on the horizontal axis. The display shows the sampling interval in the left lower corner, and the chosen measurement parameter for the statistical analysis in the first line, left of the status indicator and the possible overload indicator.

The amplitude of the vertical scale corresponds to 5 divisions. The amplitude of each division is called "scale factor" of the graph and appears in the middle of the vertical axis. This parameter is selectable in real time among 20dB, 10dB or 5dB by division. The scale factor can be set using the RIGHT (zoom +) and LEFT (zoom -) keys.

Use the UP and DOWN arrows to set the graph full scale with steps equal to the selected scale factor. In this way, the graph can be shifted UP or DOWN according to the pressed key.

An "analogue" bar indicator on the display right side provides the non-weighted instantaneous level of the input sound pressure level, as for the SLM mode bar. The parameter chosen for statistical analysis can be changed without accessing the menus, but simply using the ENTER, UP, DOWN, LEFT and RIGHT keys (for more details, see "Selecting Parameters" on page 18).

Using the Cursors

The CURSOR, LEFT and RIGHT keys on the keypad enable and move the cursor.

The second line at the top of the display shows the percentile level indicated by the cursor.

Press CURSOR again to disable the cursor.

EVENT TRIGGER FUNCTION

During measurement this function can be used to isolate a sound event identifiable by *sound level variation* or by *synchronization to an external signal* or, *manually*, by pressing a key.

The noise descriptor used by the trigger function is selected in the PROFILE view (Menu >> Trigger >> Source: LEV). The level variation that triggers the event can be *positive* or *negative* (Menu >> Trigger >> Trigger Polarity) and the *trigger threshold* (Menu >> Trigger >> Trigger Threshold and Menu >> Trigger >> Bottom Threshold) can be different from the deactivation threshold (Menu >> Trigger >> Trigger Threshold and Menu >> Trigger >> Bottom Threshold). The following figure shows an example of a positive polarity sound event capture. The sound level (L_{AF}) exceeds the trigger threshold for time T_0 and, later, the bottom threshold for time T_2 .

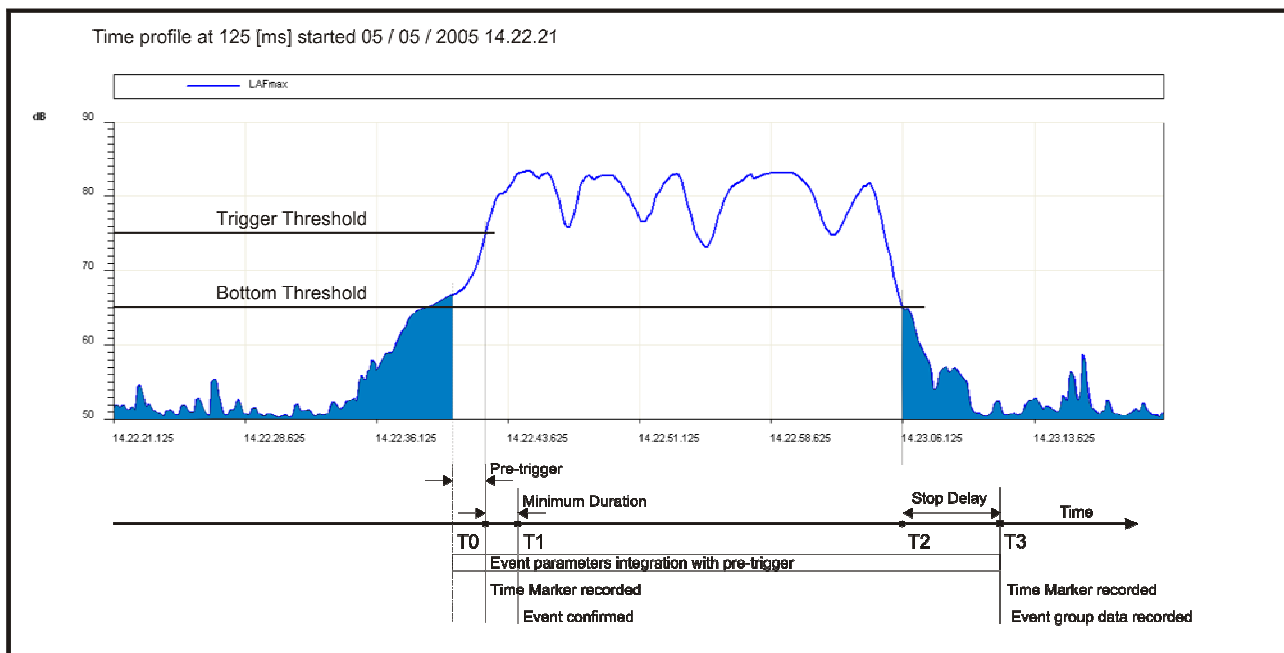

Fig. 10 - Description of the event

To prevent short duration pulses being detected as sound events, a *minimum trigger duration* can be set up to a maximum of 10s (Menu >> Trigger >> Minimum Duration). If the threshold is exceeded for less than the set time, the event is neglected. Also a *minimum deactivation duration* can be set: when the deactivation threshold is exceeded, the event close is delayed for the set time, up to a maximum of 255s (Menu >> Trigger >> Stop Delay).

In the example shown in the picture, since the trigger conditions exceed the minimum duration, that is they persist at least for time T_1 , the event levels integration begins, including the 2 seconds before the threshold is reached (*pre-trigger*). This pre-trigger time cannot be modified. The event levels integration ends at time T_3 , that is, after the *stop delay* from the T_2 time corresponding to the bottom threshold being reached.

The event trigger feature can be activate also by pressing the ENTER key (Menu >> Trigger >> Source: MAN). In this case the minimum duration parameter has no effect and the event begins as soon as the trigger is detected.

For each identified event, the HD2010UC/A calculates the following:

- 5 programmable selectable parameters: maximum and minimum levels, peak level, equivalent level and SEL
- Average spectrum by octave and, if installed, one-third octave bands

- Full statistical analysis

These parameters are not displayed but can be stored, completely or partially, at the end of each level. The menu *Recording >> Event* allows selection of the 5 parameters and memorization. The event parameters integration begins 2 seconds before triggering. This pre-trigger time cannot be modified.

A special printing function, synchronized with the trigger, is available for communication of the event itself via RS232 (Menu >> Trigger >> Print).

If the trigger is enabled, the sound level profile is displayed with black background when the trigger is not active so as to highlight the event's portion.

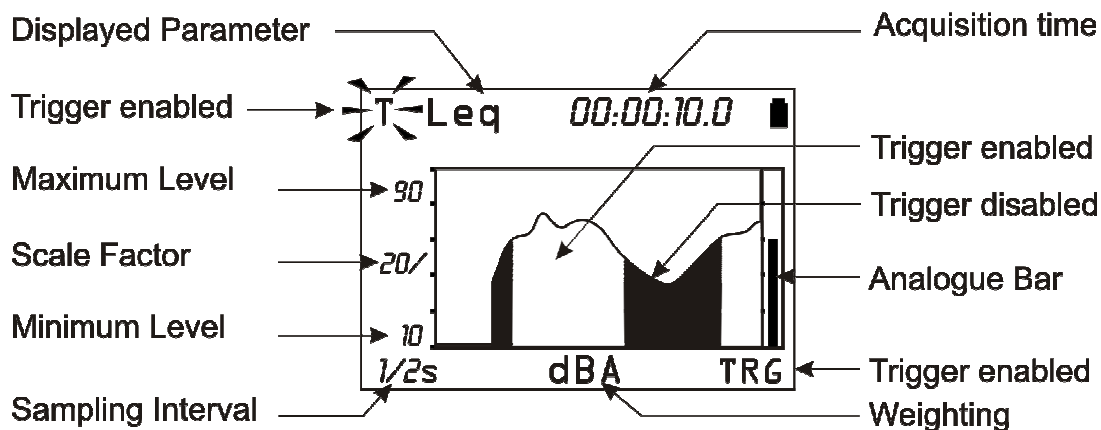
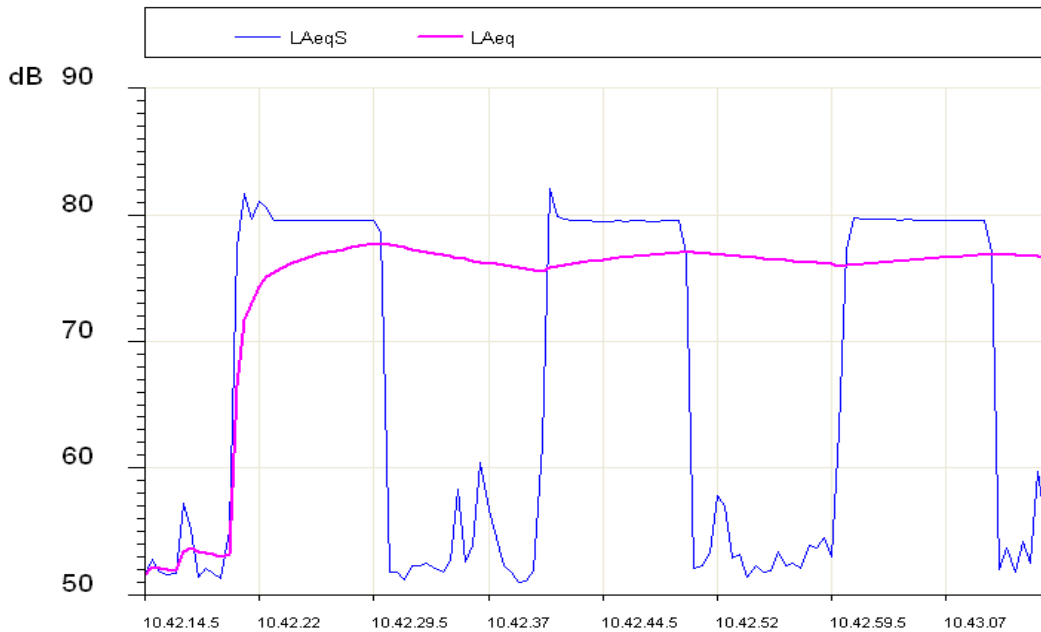

Fig. 11 - Description of the “Event trigger” display

INTEGRATION

The integration begins by resetting the integrated levels (e.g. the Leq) and ends when the set integration time T_{int} is elapsed or when the acquisition is manually interrupted by the RUN/STOP key. The following figure shows the Leq Short profile calculated twice per second and the integrated Leq over a measurement time of 1 minute.



In the measurement time span, the Leq Short (LAeqS) shows three phases with high noise, about 80dB, and a variable 52-60dB background noise. The Leq profile shows that the integration of the three high noise phases gives an equivalent level stabilizing at about 77dB at the end.

The parameter “MENU >> Instrument >> Measurement >> Integration Interval” allows to suspend the display update, when set time is over.

Now, to store displayed data press REC and hold it down *for at least 2 seconds*, then select the manual storage option. Press PRINT if you want to send displayed data to the serial output.

While display update is stopped in HOLD, the sound level meter continues measuring and calculating the sound levels; press HOLD to let display update start again. If you do not wish to continue beyond the set integration time, press STOP to interrupt the acquisition. When continuous noise level recording is active, the acquisition is automatically stopped once the set integration time is elapsed.

The PAUSE/CONTINUE key can be used to suspend the calculation of integrated levels temporarily, while instant levels are still being measured. During a pause, and as far as the integrated levels displayed on the SLM page are concerned, you can delete the last integration seconds through the “BACK-ERASE FUNCTION (DATA EXCLUSION)” see page 18. The monitor function is not affected by the acquisition pauses. The continuous recording function suspends data storage during the acquisition pauses and automatically stores a marker indicating the pause duration and the possible use of the erase function.

The sound level meter has a further timer for interval acquisition (MENU >> Instrument >> Measurement >> Report Time). This parameter can be used to break up the measurement time into programmable duration intervals from 1 second to one hour, and calculate a set of 5 selected integrated levels for each interval, namely Leq, maximum and minimum levels, SEL, and statistical levels. The average spectrum (AVR) for each interval can also be calculated by both octave band and third octave band, and using statistical analysis (MENU >> Recording >> Report). These data

cannot be displayed directly but can be recorded by enabling continuous recording. The report levels can be displayed by loading the recording from the sound level meter memory using the Navigator, and selecting the Report mode for the replay.

The following table gives the different measurement and storage modes of the HD2010UC/A.

Auto-Store	Measurements	Continuous Recording	Single Recording
OFF	Press START/STOP to start. The integration ends when $t=T.Int.$, enters in HOLD mode, and it is possible to continue by pressing HOLD or to stop with START/STOP	Press REC + START/STOP to start. Automatic stop when $t = T.Int.$	Press REC to record the displayed data.
ON	Press START/STOP to start. Automatic stop when $t=T.Int.$ with recording of the SLM, OCTAVE and T.OCTAVE screens.	----	----

PRINT AND MONITOR FUNCTIONS



If you press and soon release the **PRINT** key, you can send to a PC or to a printer, via serial interface, the screen-page displayed when pressing the key, in ASCII format. The suggested printer is model HD40.1 (see page 86).

On the instrument display, a letter “**P**”, replacing the status indicator, highlights data transfer.

If the **PRINT** key *is hold down* until the letter M (*Monitor* function) and the recording status indicator flash alternatively, the displayed screen will be continuously sent to the serial interface: press **PRINT** again or **STOP** to end the operation.

After activating the Monitor function, even if you press the **MODE** key, the type of screen sent to the serial interface will not change.

The **PRINT** function can also be selected starting from the **STOP** status. In this case the function will automatically activate as soon as the instrument switches into the **RUN** mode.

If the instrument gets into the **PAUSE** mode, the function will remain active, but sent data will be combined with the “**P**” symbol indicating the suspension status of the integrated parameter calculation.

The Monitor function does not interfere with data recording on memory and can be activated simultaneously.

A series of values is sent every 0.5s.

THE RECORD FUNCTION



The **REC** key supervises the function of recording data on the instrument memory. Two recording modes are available: *single (manual or automatic)* and *continuous* recording.

MANUAL AND AUTOMATIC SINGLE RECORDING

When only the REC key is pressed *for at least 2 seconds*, the displayed screen will be recorded as a **single record**. When you press REC and before the instrument stores the active screen, you will be asked to confirm the recording title containing order date and number. This operation can be performed in RUN, HOLD, PAUSE and STOP modes. When the single recording is activated while the instrument is in STOP mode, you will be first asked to choose between automatic and manual storage.

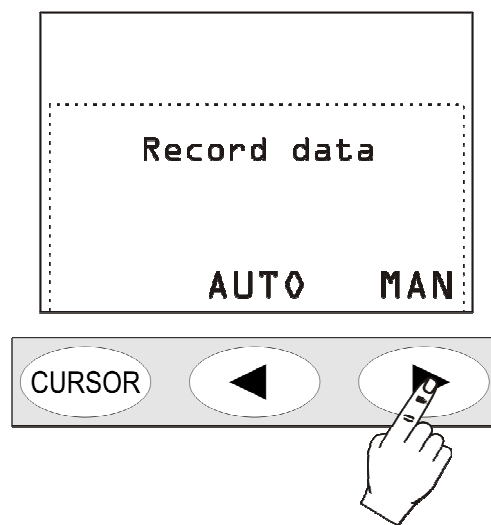

If the *manual* recording has been selected, it will happen what described above (*single record* recording).

If, on the contrary, the *automatic* “AUTO” recording mode has been selected, the sound level meter is set for Auto-Store recording. The parameter “MENU >> Data logger >> Measurement >> Auto-Store” will be activated and the REC symbol blinks over the status indicator.

Press START to begin automatic recording: as soon as the measurement time reaches the set integration time, the parameters shown on the SLM screen and the spectra by octave and third octave bands (with the “Third Octave” option) are recorded automatically.

Press REC while the instrument is in STOP mode, to disable the Auto-Store function.

The automatic recording can be also activated from the corresponding menu item (MENU >> Data Logger >> Measurement >> Auto-Store).

If the function Auto-Store is activated, the parameters displayed in the SLM mode will be stored together with the spectrum both for octave bands and, with option, for third of octave bands, once the set integration time expire. The logging will be automatically stopped.

Integration time (that corresponds to recording interval) can be set directly from SLM screen or using the specific menu parameter (MENU >> Instrument >> Measurements >> Integration time).

CONTINUOUS RECORDING

Pressing both REC and START/STOP/RESET keys starts the **continuous data recording** on memory. The 3 parameters of SLM mode are stored twice per second, while the A weighted sound level with FAST time constant is stored 8 times per second.

Press PAUSE to stop recording temporarily; press CONTINUE to restart it. As soon as you go back to the RUN status, a special record is stored, containing indications about the possible erase (see the “Back-Erase Function” in SLM mode on page 18) besides date and time.

The HOLD key does not affect data recording.

When the continuous recording is active, the integration time acts like a timer stopping automatically the acquisition as soon as the set time is elapsed. Integration time is programmable from SLM display or using the relative menu item (Menu >> Instrument >> Measurement >> Integration interval).

CONTINUOUS RECORDING OF REPORTS AND EVENTS GROUPS

You can also record reports and events, together with the sound level profiles. The parameters of the SLM and PROFILE screens are included in the **Measurement** group. Together with the Measurement group recording, you can also enable the Report and Event groups recording.

The Report and Event groups are composed of the following storable parameters:

- 5 integrated parameters
- Average spectra for octave and third octave band (with “Third Octave” option”)
- Statistics

The Report group is recorded at programmable intervals, using the parameter MENU >> Instrument >> Measurement >> Report Time, from a minimum of 1s to a maximum of 1 hour. The 5 integrated parameters, the spectra and the statistics are automatically cleared at the beginning of every report time.

The 5 reported parameters can include:

- FAST, SLOW and IMPULSE time weighted maximum and minimum levels
- Peak level
- Equivalent sound pressure level
- SEL
- Preset percentile levels L1, L2, L3 and L4

The Event group is recorded, per each detected event (see paragraph “EVENT TRIGGER FUNCTION” on page 27), at the end of the event itself. The 5 integrated parameters, the spectra and the statistics are automatically cleared at the beginning, and are integrated for the entire duration of the event. The 5 event parameters can include:

- FAST, SLOW and IMPULSE time weighted maximum and minimum levels
- Peak level
- Equivalent sound pressure level
- SEL

When the Measurement group recording is activated together with the Report and Event groups recording, the Measurement group continuous recording is enabled only with the events sensed by the event trigger. This allows a lot of memory to be saved, minimizing information losses: during the events the maximum quantity of logged information occurs, while with outside sound events, the recording of the level is also carried out according to a reduced time resolution, as defined in MENU >> Instrument >> Measurement >> Report time.

Fig. 12 shows the recording flow for the Report and Event groups.

The Measurement group recording interval is equal to 2 recordings per second.

In the following example, also the Report group items are memorized with a Report time amounting to 10s.

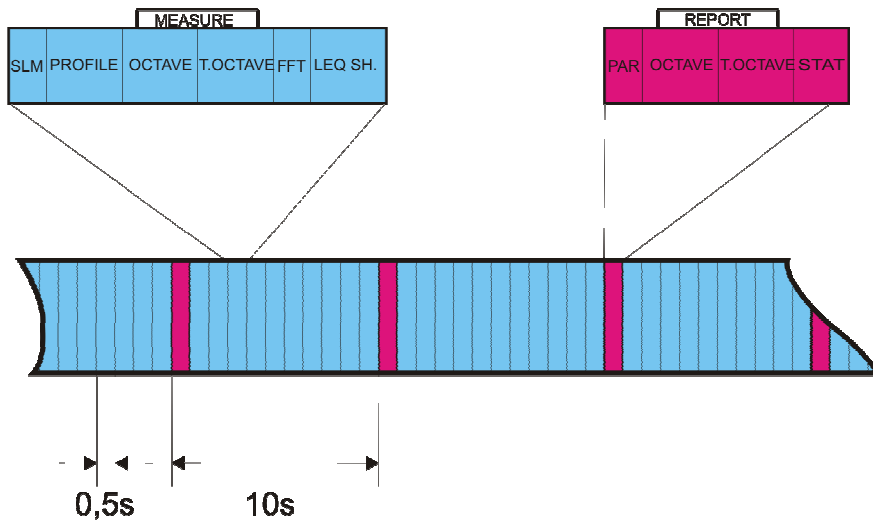

Fig. 12

When the trigger function detects an event, identified by the overcoming of the trigger threshold, or when ENTER is pressed, a time marker is recorded.

Similarly, when the end of event conditions are sensed, as identified by the deactivation threshold being reached, or by the external TRGIN signal, or when ENTER is pressed, and after the set stop delay has elapsed, another time marker is recorded. After the time marker, when the event is closed, the record containing the Event group information is logged.

When the event trigger uses the Profile view sound level as source (Menu >> Trigger >> Source: LEV), the event data are recorded only when the trigger threshold (Menu >> Trigger >> Trigger Threshold) exceeds the minimum duration time (Menu >> Trigger >> Minimum Duration).

The following figure shows the recording flow for the Measurement, Report and Event groups. The Measurement group recording is enable only during the event; outside the events, only Reports are recorded. In the following example a report is recorded every 10s.

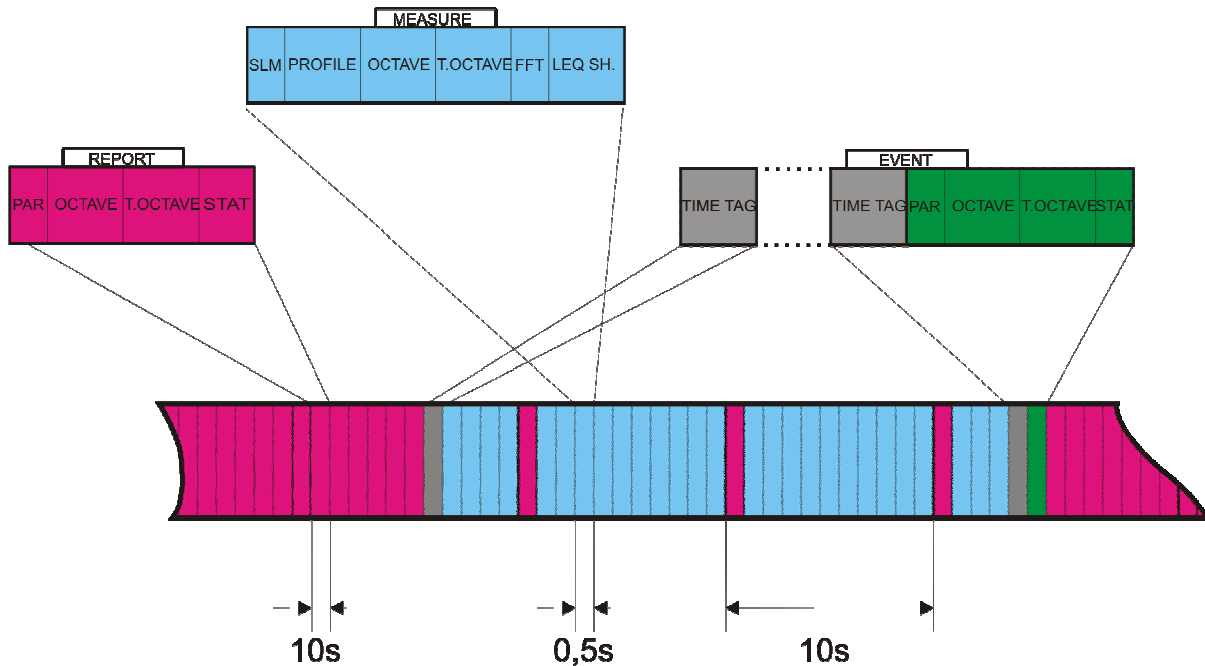

Fig. 13 - Recording flow for the Measurement, Report and Event groups

When the trigger threshold is exceeded for a shorter period than the minimum duration time, the record containing the Event group information is not logged.

Delayed acquisition timer

A timer is available to enable data acquisition according to a programmable delay of up to 99 hours. To perform an acquisition with delayed start, the recording parameters need to be set first and then the **delayed acquisition timer** programmed in the parameter Menu >> Sequencer >> Timer. After programming the sound level meter, you only need to press the **REC** and **RUN** keys together (as if starting a logged measurement): confirm with the “YES” key. The instrument switches into stand-by and turns off (see. Fig. 14).

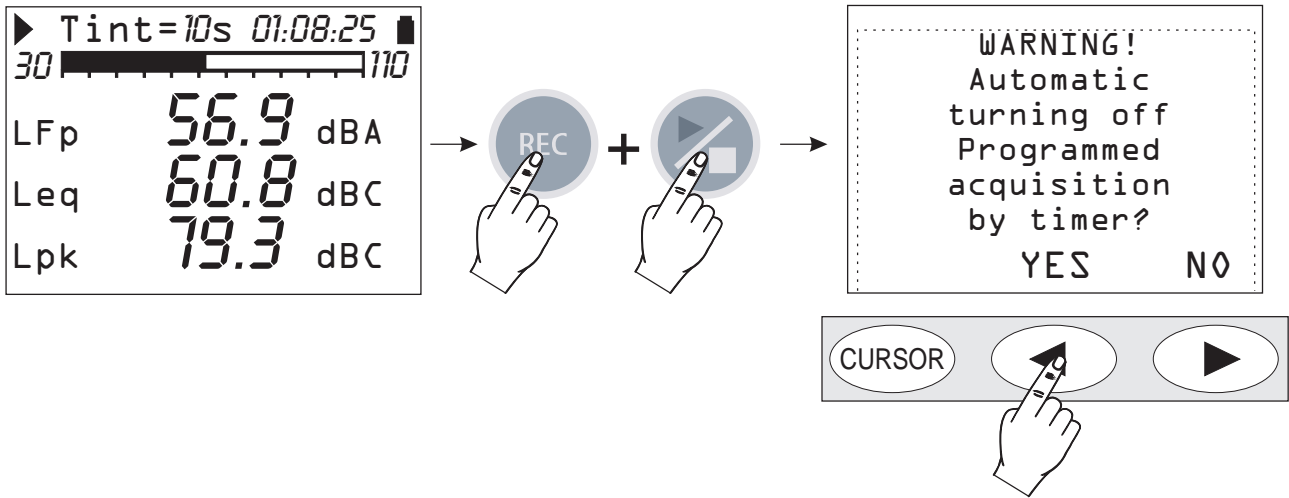

Fig. 14 - Delayed acquisition timer warning screen

The instrument will turn back about one minute before the set delay, to allow execution of the warm up time before starting the automatic acquisition. During this waiting minute, the “TIMER” message blinks, showing the automatic acquisition feature has been activated.

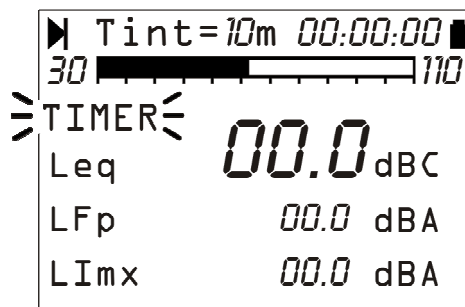
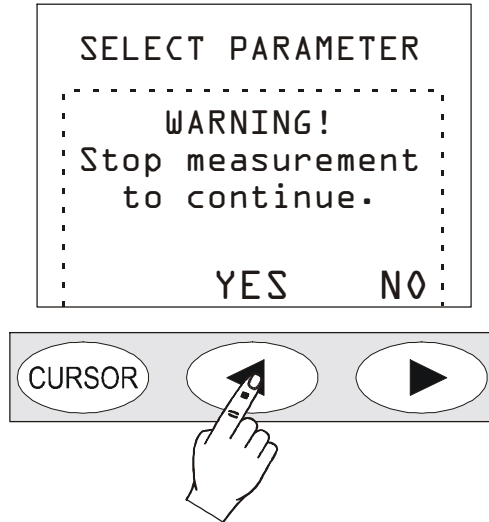

Fig. 15 - Waiting for the timer to start

The acquisition will end when the **set integration time (Tint) has elapsed** and the instrument will automatically turn off after disabling the timer.

DESCRIPTION OF THE MENU FUNCTIONS

The menu collects all of the parameters through which the instrument functions are set. The menu can be accessed even when the instrument is measuring, but parameters can be modified only if the instrument is in STOP mode. If this is not the case, a message will invite you to stop the current measurement: "WARNING! Stop measurement to continue".



Press YES, and you will be allowed to change the selected parameter.

Some of the parameters listed in the menu can also be modified directly from the measurement displays: see the chapter concerning the different display modes (from page 15 onwards).

The menu is nest-structured, that is, it is organised in menus and submenus. To select a menu item, use the UP and DOWN arrows until the selected item flashes. When the parameter next to a menu item does not flash, it means that the item cannot be changed.

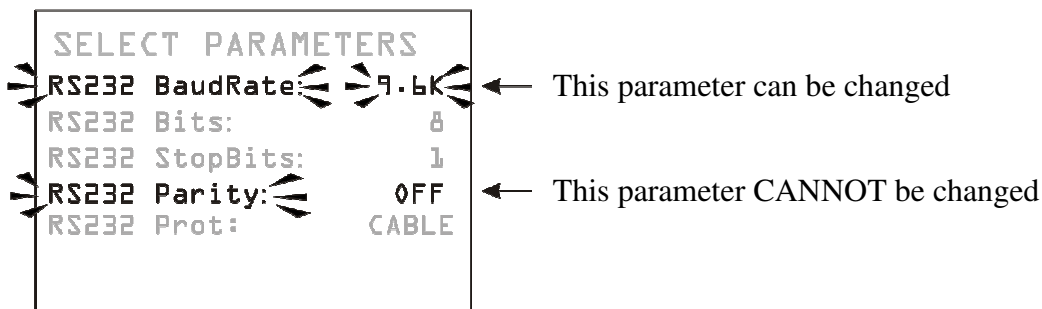

Press ENTER to access the selected submenu or to modify the selected parameter.

Use the UP and DOWN arrows to edit the flashing selected parameter: press ENTER to confirm the new value, press MENU to cancel the input changes.

Press MENU to exit a menu and return to the upper level until you get the measurement display again.

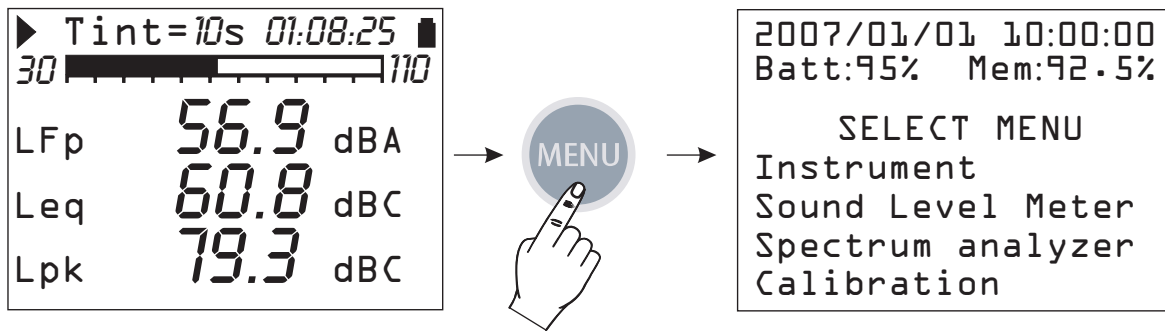

When you access the menus, current date and time are displayed, as well as the battery charge level and the available memory.

If you are in a submenu, the "SELECT MENU" item becomes "SELECT SUB-MENU".

The dots at the end of a list mean that there are other items following the visible ones: press the DOWN arrow to display them.

INSTRUMENT

The Instrument menu includes all data relevant to the instrument identification, as well as some general parameters of the instrument itself, input and output settings and measurement global parameters. It consists of four submenus, as described below.

IDENTIFICATION

It includes the information that identify the instrument and the microphone. These are all items that cannot be changed by the user.

- **Instrument:** instrument name.
- **Serial N.:** instrument serial number.
- **Version:** current firmware version loaded.
- **Microphone:** free field microphone UC52 is the standard supplied.
- **Mic. S.N.:** microphone serial number.
- **Mic. Response:** type of microphone response. FF stands for Free Field, DF for Diffused Field.
- **Class IEC61672:** Class of tolerance according to IEC61672.
- **Memory:** memory available on the instrument.
- **Options:** firmware options.
- **Ext. range:** Off.

SYSTEM

It allows configuring some system parameters.

- **Time:** current time.
- **Date:** current date expressed as year/month/day.
- **Logging Mode:** if you set Logging Mode = STD, the logging stops when the instrument memory is full; if you set Logging Mode = CIR, the logging continues, overwriting the oldest data.
- **Network address:** instrument identification number, configurable by the user.

- **Display contrast:** allows adjusting the display contrast. When the ambient temperature changes, the display contrast slightly changes: it can be adjusted entering a higher value to increase the contrast or a lower one to decrease it. The value can be set between 3 (minimum) and 9 (maximum).
- **Auto-Power-Off:** the instrument is provided with the auto-power-off function that automatically switches it off after 5 minutes if it is in STOP mode and no key has been pressed. Before switching off, the instrument will make a series of beep: press any key to prevent the instrument shutting off. The function is active if this menu item is "ON". If you set Auto-Power-Off = OFF, the instrument will not automatically shut off. **In this case the battery symbol will flash even if batteries are fully charged.**

INPUT OUTPUT

Submenu for the choice of parameters relevant to the instrument inputs and outputs.

- **Baud Rate:** this parameter and the next ones define the properties of the serial connection. Selectable baud rate values go from a minimum of 300 to a maximum of 230400 baud. The higher is the value, the faster is the connection; therefore, **when possible**, it is suggested to select the highest available value to speed up data transfer as much as possible. If the instrument is connected to a printer with RS232 serial input or with a serial/parallel converter, the value to be set is the one provided by the printer manufacturer.

WARNING: When you use the serial interface, the communication between instrument and computer (or printer with serial input) works only if the instrument and PC (or device) baud rates are the same. Take care of this note when using data transfer programs requiring a manual configuration of the serial port parameters, such as, i.e. HyperTerminal. The Noise Studio program, combined with the HD2010UC/A, automatically sets the serial port, so that no action by the operator is required.

- **RS232 Bits:** (*non-modifiable parameter*) number of bits of which transferred data are made up, the value is 8.
- **RS232 Stop Bits:** (*non-modifiable parameter*) stop bit, the value is 2.
- **RS232 Parity:** (*non-modifiable parameter*) parity bit, the value is: none (OFF).
- **Serial Device:** identifies the device connected to the serial port.

The connection possibilities are:

- **PRINTER:** connection to a printer with RS232 input
- **RS232:** connection to a PC equipped with RS232 port (physical)
- **MODEM:** connection to a modem with RS232 input (see Connection to a modem on page 85)
- **USB:** connection to a PC by USB port (see "CONNECTION TO A PC WITH USB INTERFACE" on page 87).
- **MC** connection to HD2010MC optional module for data recording on Secure Digital memory card (see specific chapter on page 89)

MEASUREMENTS

The *Measurement* item includes the acquisition general parameters.

- **Input Gain:** with Input Gain = 0 the measuring range upper limit equals 140dB, and as much as the input gain increases the maximum measurable level decreases correspondingly (see page 92). Select the proper gain according to the level of sound to be measured.
- **Quick Sampling:** integration period used to measure reverberation time.
- **Integration interval:** Once this time has been reached, the instrument automatically switches to HOLD, interrupting display update. It can be set from a minimum of 1s to a maximum of 99 hours. When continuous recording is activated, the integration time acts like a timer for da-

ta acquisition, stopping automatically the measurement when the time is elapsed. If set to 0s, the timer is disabled and the integration becomes continuous.

- **Report Time:** report parameters are integrated over intervals corresponding to the set time. At the beginning of every interval report parameters are automatically cleared. Report time can be set to: 1, 2, 5, 10, 20 and 30 seconds, 1, 2, 5, 10, 20, 30 minutes and 1 hour.
- **Max Back-Erase:** maximum erase interval of data recorded in SLM mode. The available values are: 5s, 10s, 30s and 60s: the erase interval is settable with 1s, 2s, 5s or 10s steps, respectively. See description on page 18.
- **Exchange Rate:** is used together with "DOSE Threshold" and "DOSE Criterion" in DOSE calculation. It represents the variation of the sound pressure level corresponding to the double or the half of the exposure maximum time with the same Criterion Level (indicated as "DOSE Criterion"). Its value can be equal to 3dB, 4dB or 5dB.
- **DOSE Threshold:** it is the noise level below which the DOSE is not increased. The value can be set in the 0dB÷140dB interval, with 1dB steps.
- **DOSE Criterion:** it is the noise level providing a DOSE equal to 100% after an 8 hour exposure. The value can be set in the 60dB÷140dB interval, with 1dB steps.
- **Overload Level:** if the sound level exceeds of more than 1 dB the upper limit of the measuring range, set according to the selected input gain, the display will highlight the overload indication (Δ and Λ). The indication can be activated also at lower input levels, programming this parameter from 20dB, minimum, to 200dB maximum, with 1dB steps. The shown level defines the overload threshold when the input gain corresponds to 0dB (Input Gain). The overload threshold automatically scales with the input gain.
- **Lev. 1, 2, 3 and 4 Percentile:** in the statistical analysis of sound events, L_N percentile levels are defined as the levels of noise exceeded for N time percentage throughout the whole measurement interval. For example, L_1 represents the sound level exceeded by 1% of the measurement time. These items define 4 percentile levels selectable between 1% and 99% with 1% steps. The corresponding variables are shown in the SLM view as L1, L2, L3 and L4, combined with the respective percentage.

SOUND LEVEL METER

The Sound Level Meter menu features all parameters relevant to the SLM display mode. These items can be changed directly from the respective display as described in "Selecting Parameters" on page 18.

The first three items of the menu, from Par. 1 to Par. 3, define the three measuring parameters and the respective frequency weightings relative to the SLM display mode.

Press RIGHT to change the time weighting of measuring parameters, when selected. When the time weighting flashes, use the UP and DOWN arrows to change it.

The list of available descriptors is shown on appendix A1 on page 118.

SPECTRUM ANALYZER

The Spectrum Analyser menu includes the specific parameters relative to spectra display modes. These items can be changed directly in their screens.

- **Aux Pond.:** the frequency weighting of the wideband channel combined with the spectrum and displayed with a vertical bar on the right of the spectrum. A, C and Z weightings are available.
- **Frequency spectrum weighting:** spectrum can be un-weighted (Z) or C or A weighted (stored spectrum is always LIN)
- **Octave Display:** enables (ON) or disables (OFF) displaying of octave band spectra. This parameter needs the "Advanced Analyzer" option.

- **T. Octave Display:** enables (ON) or disables (OFF) displaying of third-octave band spectra (“Third octave” option required).

STATISTICAL ANALYZER

The *Statistical Analyzer* menu collects the specific parameters related to the statistical graphs display modes. These items can be changed directly in their screens.

- **Param.:** the parameter used for selected statistical calculations: L_{Fp} , L_{eq} and L_{pk} with A, C and Z (only C and Z for L_{pk}) weightings. The sampling frequency is equal to 8 samples/s (only 2 samples/s for L_{pk}).
- **Class width:** statistical analysis is performed by 0.5dB classes.
- **Display Stat.:** enables (ON) or disables (OFF) displaying of the distribution of probabilities and percentile levels graph.

TRIGGER

The *Trigger* menu collects the specific parameters related to the event trigger.

- **Source:** the trigger source can be chosen among: profile view sound level (LEV) or pressing ENTER key (MAN).
- **Trigger Threshold:** the trigger threshold on the profile view sound level (LEV); it can be programmed with 1dB steps.
- **Bottom Threshold:** the deactivation threshold, different than the trigger one, on the profile view sound level (LEV); it can be programmed with 1dB steps.
- **Trigger Polarity:** it is possible to choose increasing (POS) or decreasing (NEG) levels for the trigger on the profile view sound level (LEV). For the increasing levels trigger, the Trigger Threshold will be higher than the Bottom Threshold, for the decreasing levels trigger the Trigger Threshold will be lower than the Bottom Threshold.
- **Minimum Duration:** a duration filter is available to eliminate false triggers. It is activated upon detection of the event, only if the trigger condition persists for a number of seconds at least equal to this parameter. It is used only if the Source parameter is set to LEV.
- **Stop Delay:** when the trigger conditions are not present anymore, the event ends after a number of second equal to this parameter has elapsed.
- **Printing:** printing of a warning string (TAG) can be enabled through the serial interface for each event.

RECORDING

In the *Recording* menu the parameters relating to the logging of the measured data can be found. It collects the settings concerning the recording of the sound levels measured in each screen, the report, and event parameters. If no parameter is enabled for recording (all OFF), the instrument warns of the impossibility to record.

The recording parameters are divided in three sub-menus: Measurement, Report, and Event.

MEASUREMENTS

In this menu continuous recording is defined, as described in THE RECORD FUNCTION on page 32.

- **Auto-Store:** activates the auto-recording mode of SLM, OCTAVE and THIRD OCTAVE screens, as described in THE RECORD FUNCTION on page 32. By enabling this feature report time and event trigger are disabled.

- **SLM + PROFILE:** activates the continuous recording of parameters of the SLM screen and PROFILE.

If the *Auto-Store* function is activated, SLM and spectra screens will be automatically stored when the set integration time is over. Integration time is programmable from SLM display or using the relative menu item (Menu >> Instrument >> Measurement >> Integration interval). The enabling of the recording mode is indicated by a flashing REC over the status indicator. Recording is started by pressing RUN. To disable the Auto-Store function press the REC key briefly.

REPORT

In this menu the recording of the reports is defined, as described in the paragraph CONTINUOUS RECORDING OF REPORTS AND EVENTS GROUPS.

Each item can be enabled separately, as with the measurement recording. In order to avoid occupying memory space uselessly, we recommend to enable only the needed items and set the others to OFF. The integration interval (recording time) of the reports is programmable using the relative menu item (Menu >> Instrument >> Measurement >> Report Time).

- **Par.1 – Par.5:** define five integrated parameters, with relevant frequency weightings.
- **Parameters:** enables recording of the 5 parameters Par.1 – Par.5, defined previously.
- **Oct. Spectrum:** activates the recording of average spectrum (AVR) by octave band.
- **T. Oct. Spectrum.:** activates the recording of average spectrum (AVR) by third octave band.
- **Statistics:** activates the recording of the statistics

EVENT

In this menu the recording of the event reports is defined, as described in the paragraph CONTINUOUS RECORDING OF REPORTS AND EVENTS GROUPS.

Each item can be enabled separately, as with the measurement recording. In order to avoid occupying memory space uselessly, we recommend to enable only the needed items and set the others to OFF.

- **Par.1 – Par.5:** define five integrated event parameters, with relevant frequency weightings.
- **Parameters:** enables recording of the 5 parameters Par.1 – Par.5, defined previously.
- **Oct. Spectrum:** activates the recording of average spectrum (AVR) by octave band.
- **Third Oct. Spectrum:** activates the recording of average spectrum (AVR) by third octave bands (it requires the “Third Octave” option”).
- **Statistics:** activates the recording of the event statistics

CALIBRATION

- **Calibration Level:** Sound level of the reference sound source used for the sound level meter calibration. Allowed values vary from 90.0dB to 130.0dB with a 0.1dB resolution.
- **Microphone Response:** allows selecting the type of frequency response of the microphone according to the sound field. The standard setting for the microphone (UC52) is “Free Field” (FF), since it has a frequency response optimized for the “free field”. Set the parameter to “Random Incidence” (RI) to activate the correction for sound random incidence. This setting is necessary to carry out measurements according to ANSI standards. La The random incidence correction is not available on the HD2010UC/A type 2.
When HDWME outdoor microphone protection is used, the right setting for the measurement of aircrafts noise (0°) is FF, while for community noise coming from the ground (90°) the correction to apply is RI.

- **Screen correction:** it allows to correct the sound level meter frequency response when the windshield HDSAV, supplied with the instrument, or the outdoor protection HDWME are installed. When this parameter is set on SAV or WME, the sound level meter frequency response is corrected for the presence of the windscreen or the outdoor microphone protection respectively. The correction for the windscreen is not available for HD2010UC/A type 2. For additional details on the correction to be applied, please see the UC52 microphone specific manual.

SEQUENCER

- **Timer:** programmable acquisition delay in seconds, minutes, or hours up to a maximum of 99 hours (see paragraph Delayed acquisition timer on page 36).

PROGRAMS

The item PROGRAMS (**PROG** key) includes the following functions:

- display of the stored data (*NAVIGATOR*)
- electric and acoustic calibration (*ELECTRIC CALIBRATION* and *ACOUSTIC CALIBRATION*)
- diagnostic test of instrument (*DIAGNOSTIC CHECK*)
- reverberation time measurement (*REVERBERATION TIME*) – optional program
- Data download on MC: this program allows to copy measurement data stored on the sound level meter's flash memory to a Secure Digital external memory card (please see chapter HD2010MC MEMORY CARD READER on page 89)

Each program is here below described in detail.

NAVIGATOR

This program, allows to access data stored on the instrument memory, display and print them, with no need to download them to a PC. It works both with single session data and with multiple ones). Press: PROG >> Navigator >> ENTER to access it. The following screen will appear:

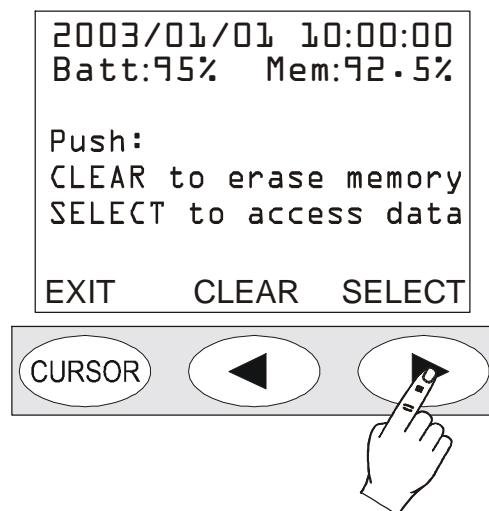

If you press CLEAR, the content of the instrument memory will be cleared. The user will be asked a confirmation before clearing.

Press SEARCH to access the first session of stored data (data on memory).

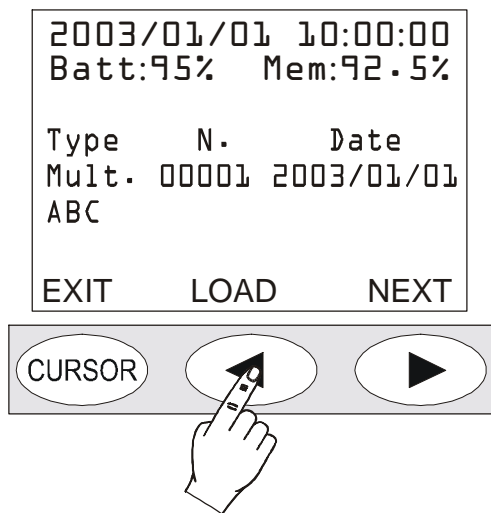

The following data are indicated for each file: the type (single, multiple, automatic or reverberation), the progressive number given by the instrument upon logging and the date. Press NEXT to jump to the next file, press LOAD to download the current file. If you press LOAD, the instrument goes back to standard display and the STOP and battery symbols alternate with the R (Replay) and P (Program) letters respectively.

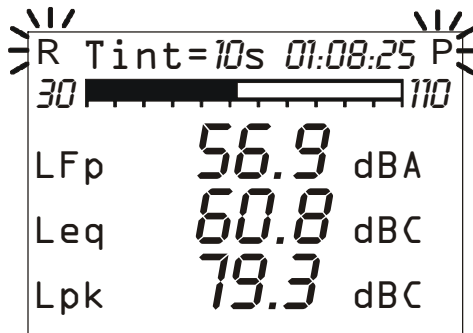

The types of files recorded are four:

- Sing. Single screen in manual recording
- Auto SLM, OCTAVE and THIRD OCTAVE (if option is installed) screens in automatic recording
- Mult. Multiple screens in continuous recording
- RT Reverberation measurements (with the option “Reverberation Time”)

File type: “Auto”

Press START to see the data session: the screens of the measurement session will be displayed as per the acquisition order. During the replay, the display mode can be changed jumping from a screen page to another, press PAUSE/CONTINUE to interrupt and re-start the on-screen reproduction or press STOP to finish it.

At the end, the instrument will position on STOP. A single screen page can be sent at any moment to the serial interface.

While the replay is in pause, press START if you want to display the next data. If, while in pause, the START key is hold down, the replay will be forwarded fast.

File type “Mult.”

Press START to see the data session: if no reports and/or events were recorded, the measurement session screens will be displayed, as for the “Auto” files. If, in addition to measurements, reports and/or events were also recorded, an intermediate page is displayed allowing the display of

measures, reports, or events to be chosen (see paragraph CONTINUOUS RECORDING OF REPORTS AND EVENTS GROUPS on page 34).

When you replay the reports or events, in SLM view, the report and event parameters are respectively displayed. When you display the events, they are displayed individually with a pause between one and the next. During the pause, START allows the next event to be reloaded and PAUSE to restart the replay.

The replay of measurements associated with event recording, automatically enables the pauses at the beginning and end of each event trigger. These pauses correspond to the time markers recorded when the trigger spots the event and at the end when saving the relevant data.

If the recording contains measurements, reports, and events, the measurements are not registered continuously but only in coincidence of the sound events detected (see EVENT TRIGGER FUNCTION on page 27).

Disabling of measurements outside the events, in combination with event and report recording, allows two different recording speeds to be maintained, slow and fast, associated with reports and measurements respectively. The maximum recording resolution is used only during events by enabling the Measurement group parameters recording (see CONTINUOUS RECORDING OF REPORTS AND EVENTS GROUPS on page 34) while for the other acquisition elements only the Report group parameters are recorded, using a lower time resolution.

When the simultaneous recording of measurements, reports, and events is enabled, and the event trigger uses the Profile view sound level as source (Menu >> Trigger >> Source: LEV), the measurement recording begins as soon as the sound level exceeds the trigger threshold (Menu >> Trigger >> Trigger Threshold) without waiting for the minimum duration time (Menu >> Trigger >> Minimum Duration). The measurement recording ends as soon as the stop delay has elapsed (Menu >> Trigger >> Stop Delay) after the level exceeded the deactivation threshold (Menu >> Trigger >> Bottom Threshold).

File type: “Sing.” and “RT”

The relevant data are loaded and displayed automatically. “RT” files require a few seconds for the data processing required for display.

After having examined a file size, press **PROG** to jump back to the Memory Navigator menu: press **LOAD** to reload the current session, **NEXT** to display the properties of the next session or **EXIT** to quit.

At the end of the list of stored files, “End of Dump” will be displayed. Press **REWIND** to go back to the first file of the list.

CALIBRATION

Calibration is periodically carried out to ensure the validity of measurements performed by the sound level meter and to control possible long-term drifts of the measuring chain microphone-preamplifier-instrument.

The HD2010UC/A sound level meter stores all calibration typical parameters with respective date and time in a reserved area. Calibration types can be:

- *Acoustic calibration* by means of a 1kHz sound level generator, like HD2020
- *Electric calibration* (Capacitive Transducer Calibration) with the possibility to measure the frequency response of the whole measurement chain, microphone included, using the built-in signal generator.

Calibration is necessary every time that the calibrator level, measured by the sound level meter, deviates from the nominal value for more than 0.5dB.

The acoustic calibration includes the capacitive transducer one and, before carrying it out, it is suggested to ensure that the environment where you are operating is suitable: no sudden sounds, no vibrations on the surface where the instrument is placed, instrument thermal stability. **The electric calibration allows a quick inspection of the electric parameters of microphone and instrument.** The calibration procedure includes the inspection of the microphone polarization. Calibration programs are in the “PROGRAMS” menu, accessible through the PROG key.

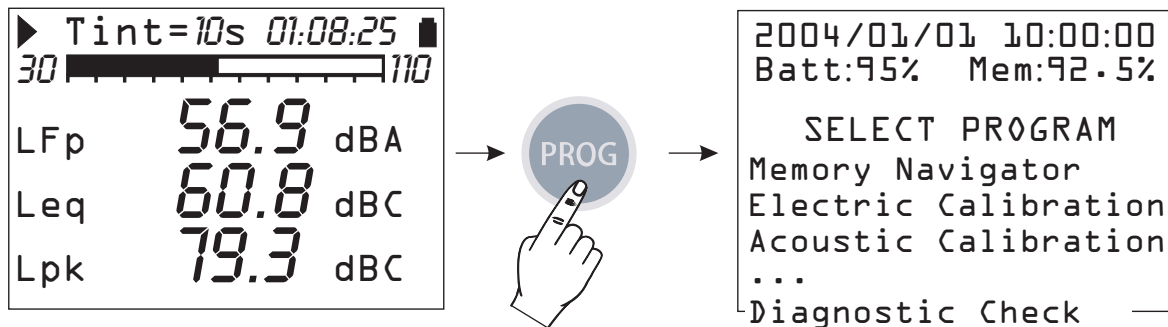

Use the UP and DOWN arrows to select the calibration to be carried out:

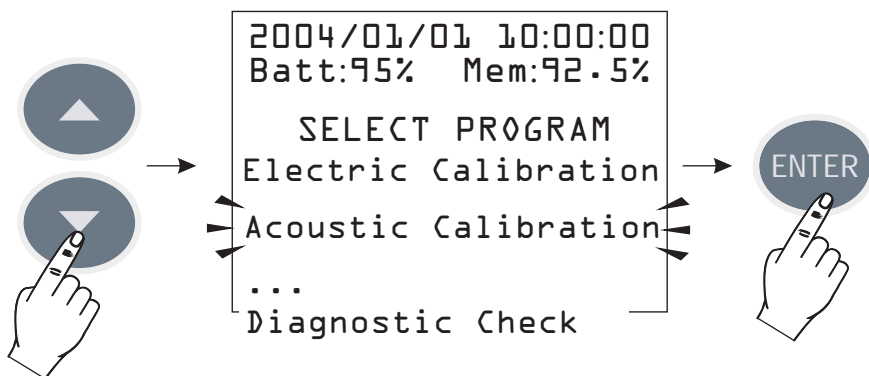
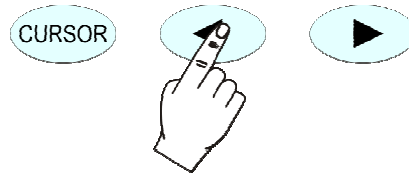
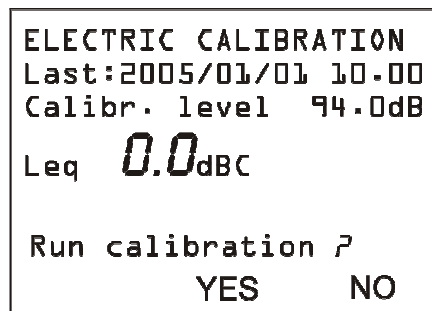

Fig. 16

when you press ENTER, the calibration display will appear.



The screen shows date and time of the last calibration and the calibrator sound level according to the configuration of the respective parameter (MENU >> Calibration >> Calibr.Level). Answering positively to the request to continue, the selected calibration program will start.

Calibration procedures are carried out in automatic mode and the operator is guided by the on-screen instructions.

The calibration result is displayed when the procedure is over and you can choose whether to confirm it or not. **If confirmed, the new calibration will be stored.**

In order to grant the highest measuring accuracy when the wind shield is mounted, select “Wind Shield Correction” from the CALIBRATION menu to apply a correction to the sound level meter frequency response and compensate the effects of the HD SAV shield provided with the instrument. All measurement parameters with wideband frequency weightings and with constant percentage bandwidths, either octave or third octave, are automatically adjusted.

Besides the windshield correction, the adjustment for the acoustic field can be activated too. With the microphone (UC52), which has a frequency response optimized for the “Free Field”, no correction is applied when the correction is set on “Free Field” (FF). When you set the correction on “Random Incidence” (RI), the correction for random incidence sound will be activated. This setting is necessary to perform measurements according to ANSI standards (see the parameter of the menu: CALIBRATION >> Microphone Response).

The HD2010UC/A sound level meter is suitable for measurements on site in a temperature range between **-10°C to +50°C**, in a static pressure range between **65kPa and 108kPa** and in a relative humidity range between **25% and 90%**. The microphone itself has defined drift coefficients of acoustic sensitivity with temperature and static pressure that imply a measurable drift of the Microphone-preamplifier-instrument chain, even though within the limits specified by IEC 61672 standard. The following table gives the maximum values of the acoustic sensitivity drift coefficients or the measurement error within the a.m. operating range, for the different microphones supplied with the HD2010 sound level meter.

PERIODIC CALIBRATION

The periodic calibration of the HD2010UC/A sound level meter is needed to ensure the traceability to the laboratory standards and is carried out in accredited laboratories. The HD2010UC/A sound level meter is calibrated at Delta Ohm Acoustic Laboratory before being supplied to the user.

“Factory” calibration, which is always made on new instruments and at every periodic calibration (every 2 years, at least), includes the measurements of the acoustic response in pressure of the microphone-preamplifier-instrument chain, stored on the sound level meter non-volatile memory, together with the microphone acoustic sensitivity. Right after the measurement of the acoustic response in pressure, also the Capacity Transducer Calibration (sound level meter electrical calibration including the microphone) is carried out, to be used as a reference for the calibrations made by the user.

Every time a periodic calibration of the sound level meter is carried out at the factory, calibration constants are stored as a reference for following comparisons. The factory calibration can be loaded onto the instrument to make a comparison or to correct a wrong calibration. This procedure will also load the instrument default parameters so that, if there are any data stored on memory, these will be deleted.

Follow this procedure to proceed with this operation:

- Download any data stored on memory
- Ensure that logging is on STOP mode
- Remove the external power supply, if connected
- Disconnect the batteries: the instrument will obviously switch off (this operation assures that all the sound level meter internal circuits are discharged)
- Wait some minutes: this operation ensures that all internal electronic circuits are discharged
- Connect the batteries while holding down the ENTER key
- The instrument will automatically turn on and will show a warning message indicating that factory parameters have been loaded
- Press CONTINUE to confirm and make an acoustic calibration to store calibration constants. If this operation is not carried out, or in case the acoustic calibration should give a negative result, upon the next power on, factory calibration data will be replaced by those stored in the last successful calibration.

Electrical signals supplied by a generator connected to the HD2010UC/A preamplifier via a capacitive adapter (replacing the microphone) can be used for periodic tests. Specific capacitive adapter for supplied microphone is an accessory available from Delta Ohm. It's possible to use other supplier's capacitive adapters provided that the equivalent capacity of the device is within 15 pF and 33 pF.

Before carrying out electrical and acoustic laboratory tests, it's necessary to disable spectral corrections on the equipment under test. The setting is the following:

- Menu >> Calibration >> Microphone Response Correction >> FF
- Menu >> Calibration >> Shield >> OFF

The frequency response check is made on a closed coupler under pressure field conditions, as for example using a multi-frequency calibrator B&K 4226. For more information on corrections to be applied to the frequency response please see the manual of UC52 microphone.

ELECTRIC CALIBRATION

The electric calibration, using the partition of charge injected into the microphone preamplifier in “charge amplifier” configuration (Capacitive Transducer Calibration), even if it cannot completely replace the acoustic calibration, provides however a useful means to keep under control the instrument drifts, microphone included. The figure on the right shows the diagram of the CTC technique consisting in sending an electrical signal to the preamplifier through a high stability capacitor, so that the output signal does not depend only on amplification, but also on the microphone capacity. Many of the microphone malfunctions reflect in a capacity drift identifiable by means of this calibration technique.

The electric calibration uses as a reference the result of the last acoustic calibration, and according to it corrects any possible drift of the instrument.

The electric calibration adjusts the acoustic response of the microphone-sound level meter chain, both for wideband channels, and for those with a constant percentage bandwidth. In case of high instrument drift with respect to the previous calibration, it is suggested to carry out an acoustic calibration and to check the instrument frequency response to verify that there are no other problems in the measuring chain.

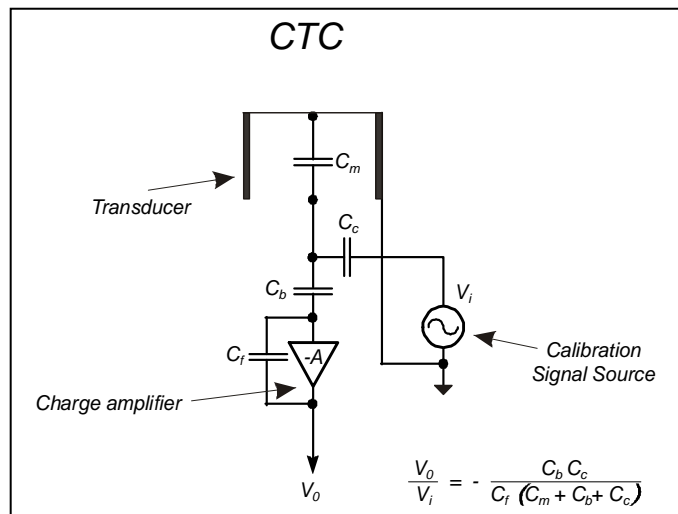

Operating Procedure

Switch on the sound level meter, if it is the case, press STOP to finish the measurement in progress and make the following procedure:

1. Press PROG and use the DOWN arrow to select "Electric Calibration".
2. Press ENTER to start the function.
3. The inner signal generator will be turned on and the measured output signal will be compared with the one detected in the last acoustic calibration.

The value that appears on the display (51.3dBC in the example below), before starting calibration, is the valued measured by the microphone upon pressure of the PROG key, and is not relate to the calibration in progress.

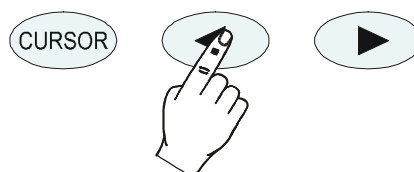
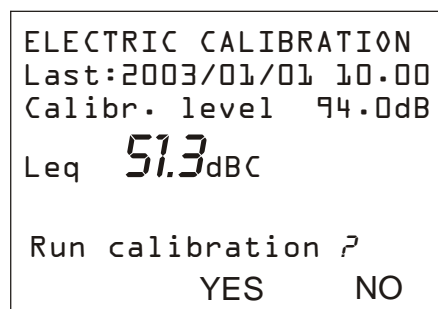

4. Press YES to continue and NO to quit.

5. If you press YES, the calibration is run: wait till the procedure will be over.
6. At the end, the calibration result will be shown and you will be asked to confirm a new calibration:

```
ELECTRIC CALIBRATION
Last:2003/01/01 10.00
Calibr. level 94.0dB
  ΔLeq -0.1 dBC
Confirm calibration ?
      YES    NO
```

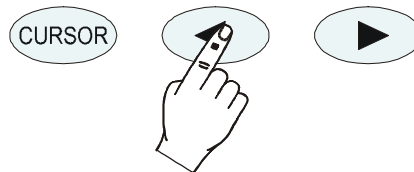

7. Press YES (keypad LEFT key) to confirm or NO (keypad RIGHT key) to refuse the calibration just finished. At the end, the instrument will switch to the SLM display, in STOP mode.

The stabilization on a value far from the reference one, indicated by a ΔLeq higher than some tenths, means that one of the components of the microphone-preamplifier-instrument chain was affected by a considerable drift and if this difference exceeds the maximum limit admissible by the instrument, calibration will fail. In this case, refer to “Troubleshooting” (page 109), and if necessary contact our service department.

ACOUSTIC CALIBRATION

In order to keep the acoustic sensitivity of the microphone-sound level meter chain steady over time and in the different usage conditions, a reference sound source is used, which generates a pure tone at a reference frequency with a given pressure level, stable over time. For this purpose type 1 and type 2 (according to IEC 60942) acoustic calibrators compatible with UC52 microphone capsule are used. For the HD2010UC/A sound level meter are available Class 1 HD2020 and Class 2 HD2022 calibrators.

The control that the reference sound level provided by the acoustic calibrator is correctly measured by the sound level meter (it is normally acceptable that the difference between the sound level measured by the sound level meter and the nominal level of the calibrator be lower than 0.5dB) has to be carried out before and after a series of measurements, to ensure that measured values are correct. When the difference between the calibrator sound level measured by the sound level meter and the nominal value is higher than 0,5dB , a new acoustic calibration has to be carried out.

Warning: to prevent damaging the sound level meter, it is important, during the calibration procedure, to follow carefully the on-screen instructions and the indications provided by this manual.

Operating Procedure

Switch on the sound level meter, if necessary, press STOP to finish the measurement on progress, and perform the following procedure. The program will automatically control that the warm-up time, indicated by a flashing W, is over.

1. Press PROG and, with the help of the DOWN arrow, select "Acoustic calibration". Press ENTER to start calibration.

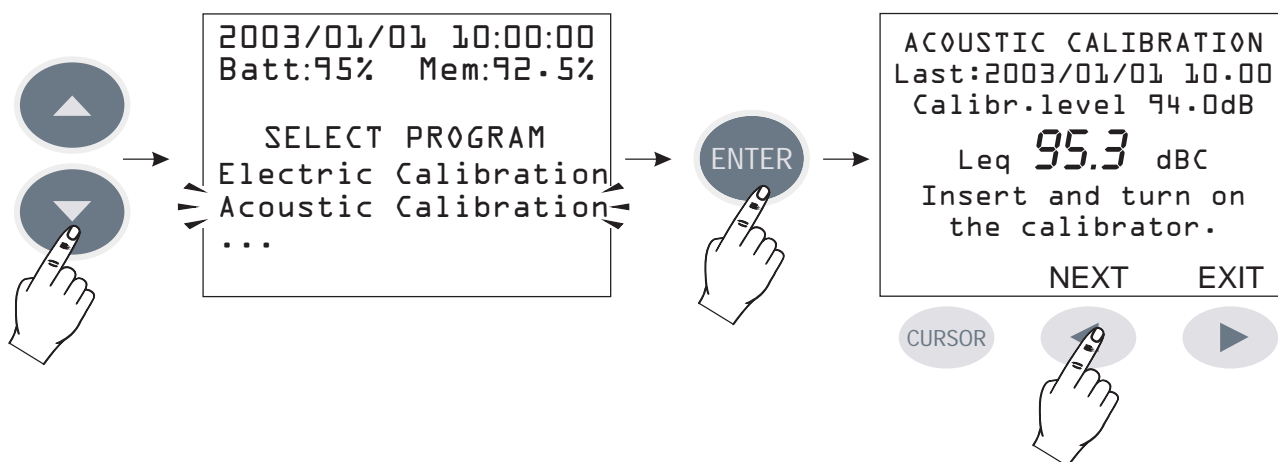

2. The first screen shows the date of the last calibration (Date:...) and, in the line below, the calibrator sound level to be used in the calibration in progress (this value can be modified, before starting the calibration program, by selecting "Calibration Level" from the MENU: see page 42). Gently insert the microphone in the calibrator hole and switch it on.
3. Select the sound level indicated on the sound level meter display (94dB is the reference value), then press NEXT to continue.
4. Now, the instrument measures the sound level applied and waits for it to become steady: the measured level will be displayed. The indication "Waiting for level stabilization..." will be viewed.

When the sound level has stabilized, the measured value is compared to the reference one and if the difference is acceptable, it is logged. In this case, the message "Turn off the Calibrator" will appear. Press NEXT to continue.

```

ACOUSTIC CALIBRATION
Last:2003/01/01 10.00
Calibr.level 94.0dB
Leq 94.0 dBC
Turn off the calibra-
tor.
NEXT

```

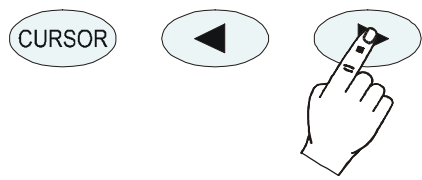

5. After the acoustic calibration, the **electric calibration** will be automatically started. This stage of the procedure generates the reference data for the following electrical calibrations.

```

ACOUSTIC CALIBRATION
Last:2003/01/01 10.00
Calibr.level 94.0dB
ΔLeq 12.5 dBC
Waiting for electric
calibration ...

```



```

ACOUSTIC CALIBRATION
Last:2003/01/01 10.00
Calibr.level 94.0dB
ΔLeq -0.1 dBC
Confirm calibration?
YES NO

```

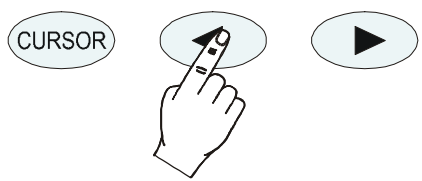

- 6. At the end, if the values of the electrical calibration are acceptable, press YES to confirm the new calibration (LEFT arrow of the keypad); press NO if you want to cancel the whole calibration (RIGHT arrow of the keypad).
- 7. Finally, the microphone polarization check is carried out. Wait until "Take out the calibrator" appears (take out the preamplifier from the calibrator)".

```

ACOUSTIC CALIBRATION
Last:2003/01/01 10.00
Calibr.level 94.0dB
ΔLeq -0.1 dBC
Checking microphone
polarization ...

```



```

ACOUSTIC CALIBRATION
Last:2003/01/01 10.00
Calibr.level 94.0dB
Leq 96.1 dBC
Take off the
calibrator
EXIT

```



8. Take out the preamplifier from the calibrator and press EXIT.

9. The procedure is over.

If calibration constants were incompatible with a correct working of the instrument, calibration would fail and the message “Calibration failed! Consult the manual” would appear. In this case, refer to “Troubleshooting” (page 109) and if necessary contact our service department.

MICROPHONE REPLACEMENT

The HD2110 sound level meter is calibrated in the factory in conjunction with the microphone. If the microphone capsule sensitivity deviates too much from factory calibration, the sound level meter blocks acoustic calibrations and reports the microphone as damaged.

The acoustic calibration can therefore fail even if the capsule is replaced or repaired, or if using a capsule with different characteristics from the one supplied.

If you wish to change the microphone capsule, you must use the relevant wizard in Noise Studio under the menu “Instrument management >> New microphone”. The procedure, which requires a certified sound calibrator to be used, is described in detail in Noise Studio’s online Help.

DIAGNOSTIC CHECK

The diagnostic test is a program that verifies a series of electrical critical parameters. The following are checked: supply voltages, microphone polarization and sensitivity, the type of preamplifier and the temperature. At the end of the procedure, should it fail, a table will be shown with the results of the inspection. If necessary, refer to “Troubleshooting” page 109), and if necessary contact our service department.

REVERBERATION TIME MEASUREMENT

The “**Reverberation Time**” program is available as an option on the HD2010UC/A sound level meter. The measurement of reverberation time requires the use of a sound source, an omnidirectional microphone and a measuring device that can measure the sound decay in the environment being tested. The reference standards for reverberation time measurements are the EN ISO 3382/2008 and the EN ISO 354/1985.

Typical applications of this function are the measurement of acoustic parameters in theatres, auditoriums, rooms for music reproduction and also the determination of airborne sound insulation of buildings like apartments, schools etc.

INSTRUMENTATION AND MEASUREMENT CONDITIONS

The EN ISO 3382-2 Standard: “*Acoustics -- Measurement of room acoustic parameters -- Part 2: Reverberation time in ordinary rooms*” was updated in 2008. This standard sets the criteria and imposes the choices on which instrumentation to use and on measurement conditions in order to make the results as repeatable and comparable as possible.

Concerning the sound source, it has to meet the precise requirements for omni-directionality of emission and signal/noise ratio in all concerned acoustic bands, typically in the octaves from 125Hz to 4kHz (or third octave from 100Hz to 5KHz).

The omni-directionality must be accurately verified: the maximum acceptable deviations, as an average for each 30° around the source, are the following:

Frequency [Hz]	125	250	500	1000	2000	4000
Max Departure [dB]	±1	±1	±1	±3	±5	±6

In order to evaluate the minimum acoustic level of the source for each octave band so as to measure the reverberation time, analysis of a decay equal to at least 20 dB, starting from 5 dB under the stationary level, is sufficient. By estimating that the background noise of the environment, in order to be negligible, should be at least 10dB under the minimum level considered for the decay not to influence it significantly, **the emitted sound source level should be at least 30 dB higher per each band compared to the background noise.**

Normal speakers are usually suitable to be used as sources for reverberation time measurement because of the typical strong directionality of sound emission. Usually a special sound source composed of a series of twelve loudspeakers arranged on the figure of a dodecahedron is used.

For the measurement technique which uses an impulse source, gun shots or balloon explosions are normally used.

Concerning the microphone choice, it is important to evaluate its *directionality* and its *frequency response* characteristics. In fact, 1/2” microphones with frequency response optimized for *pressure acoustic field* are the best choice. Alternatively it is possible to use microphones optimized for *random acoustic field* or for *free field* applying in such case the correction for random noise incidence.

Measurement position

The measurement position is important because the measurement results depend on the position both of the source and of the microphone. It is therefore fundamental to consider a number of positions suitable to describe the environment being tested, both for the source and for the microphone. The position of the source should consider the actual points where the sound source will be located according to the most usual occupancy of the environment. Typically, a minimum number of two or three source positions are considered, except for the case of a small conference room where it is possible to consider only the single typical position of the lecturer. The height from the floor is usually equal to 1.5m.

For each position of the source, different microphone positions need to be analyzed by considering the actual distribution of the listeners. The distance of the measurement points should be at least 2m and they must be at least 1m from walls or reflecting surfaces. The average height from the floor (considering that listeners are usually seated) should be 1.2m. The minimum distance from the source must be equal to:

$$d_{\min} \approx 2\sqrt{\frac{V}{cT}}$$

where V is the volume of the environment in m^3 , c is the sound speed (343 m/s at normal temperature) and T is the estimated value for the reverberation time. Usually the minimum distance is not less than 3 meters.

The analyzing device can be reduced to the minimum by using a simple recorder that can guarantee the minimum time resolution required to measure the decay. ISO 3382 considers two possible types of measurement for the sound level to be registered: *the sampling of the acoustic level exponentially weighted and the recording of linearly integrated levels*. In case the acoustic level exponentially weighted is measured, it is necessary for the exponential average time to be lower than and as close as possible to $T/30$ where T is the reverberation time.

For the linear integration sequence, the time of each integral must be lower than $T/12$. There are no advantages in reducing the linear integration time below this value. The HD2010UC/A carries out a linear integration of sound level on time intervals corresponding to 1/32s; according to ISO 3382, it can therefore perform reverberation time calculations starting from a reverberation time of 0.375s.

The measurement device must estimate the reverberation time by measuring the gradient of the decay curve over a decay of at least 20 dB and then estimating the necessary time for a decay equal to 60 dB, according to the definition of reverberation time. Of course, with this type of device the recording and the measurement needs to be repeated for all the positions of the source and the microphone and for all the octave and third octave bands.

Using a modern frequency analyser as the HD2010UC/A it's possible to carry on the analysis in parallel on all the frequency bands; this analysis is known as *multi-spectrum analysis*, as spectra are calculated at regular time intervals.

Estimations of the reverberation time T_{10} , T_{20} and T_{30}

The reverberation time measurement taken by analyzing a reverberation sample equal to 60 dB is usually not feasible due to the insufficient signal/noise ratio of the source. The reverberation time is usually *estimated* starting from the measurement of the decay time over a limited stretch equal to 20dB or 30 dB, starting from 5 dB under the stationary level. These estimates of the reverberation time are indicated as $T_{60}(20)$ (or T_{20}) and $T_{60}(30)$ (or T_{30}).

In practice a linear interpolation is carried out using the Ordinary Least Squares on the decay starting from the point 5 dB lower than the stationary level and stopping, for example, 35 dB below this level. The gradient of the straight line gives the decay rate in dB/s from which the reverberation time can be extrapolated.

MEASUREMENT USING A STATIONARY NOISE

To perform the reverberation time measurement with the sound source interruption technique, an omnidirectional sound source (typically a dodecahedron loudspeaker) should be used, powered by a wide band signal that covers the acoustic spectrum required for the measurement.

The wide band signal issued by the source is usually of two types: **white** or **pink**. The issued noise is defined as “**white**” when the spectrum density is constant all over the audio frequency range. It is defined as “**pink**” when the spectrum density is inversely proportional to the frequency. Analyzing the spectrum of a white noise source by bands with a constant percentage width, as octave or third of octave bands, the sound level increases with frequency by 3dB per octave. Instead, in the case of the pink noise source, the sound level spectrum, analyzed by constant percentage bands, remains constant over the whole frequency range.

The analysis can be done sequentially for each band or in parallel for all the bands. For the sequential analysis it is possible to use a source which has already been filtered so as to issue energy only in the band concerned, with a perceptible improvement of the signal/noise ratio. In the case of the parallel analysis, by therefore simultaneously acquiring the decay of all measurement bands, the source will usually be a pink noise source that can overcome by at least 30 dB the background noise for all the concerned bands, at least from 100 Hz to 5 kHz.

To perform the measurement, firstly a stationary regular sound needs to be generated by maintaining the source on at a constant volume for a time of at least one fifth of the reverberation time.

In addition to the sampling of the constant level reached in the environment and of a decay of at least 20dB, the background noise needs to be sampled in order to assess the measurement conditions.

Because of the random nature of the excitation signal, the measurement technique with the sound source interruption presents a remarkable variability in the measurement, especially at low frequencies and therefore requires the calculation of averages in order to reduce the irregularities of the decay curve and to improve the accuracy of the slope measurement. The minimum number of measurements according to the standard is equal to 3.

According to ISO 5725, the repeatability of the reverberation time measurement according to the number of averages calculated is equal to:

$$r_{30} = \frac{200}{\sqrt{BNT_{30}}}; r_{20} = \frac{370}{\sqrt{BNT_{20}}}$$

respectively for T_{30} and T_{20} where r is expressed as a percentage and B is the bandwidth of the filter used, respectively equal to $0.71f_c$ and $0.23f_c$ for filters with bandwidth equal to an octave or third of octave. In addition to calculating the reverberation time T_{30} or T_{20} **it is necessary to analyze the decay curve visually to check the possible presence of anomalies in the decay and also for possible double gradients**. It needs to be remembered that if the linear correlation coefficient calculated with the Ordinary Least Square method on the interpolated stretch is lower than 0.95 it is not possible (according to ISO 3382) to consider the measurement valid and therefore the reverberation time cannot be defined. In some cases it is possible to measure two different slopes, one for the initial stretch of the decay curve and one for the final stretch.

According to ISO 3382 the signal/noise ratio must respectively be at least 45 dB and 35 dB for the T_{30} and T_{20} measurements.

ISO 3382 standard contemplates the possibility of calculating the reverberation time from the impulse response of the environment being tested by using a numeric technique developed by Schroeder. This technique allows, starting from the measurement of the environment response to the sound impulse, to obtain the same decay curve that would have been measured by the stationary noise technique. Indeed, each decay curve obtained using this technique corresponds to the average of an infinite number of sound decays obtained using the stationary noise technique, as demonstrated by Schroeder and as recognized by ISO 3382 that considers the repeatability of a single measurement with the impulse response technique equal to the repeatability associated to the average of 10 measurements carried out using the stationary noise technique.

The impulse response can be obtained by using different methods, and not necessarily using a sound source of an impulsive nature. Let us only consider the example of the impulsive source generated by a gun shot or the explosion of a balloon, as they are the most frequently used, even though they are not always usable or advantageous.

From the idea that the impulsive source produces an ideal impulse, the signal detected will be the direct response to the impulse of the environment. This approach is radically different to that of the stationary noise source, as *no stationary conditions are reached and therefore the answer is strongly dependent both on the position of the source and of the microphone*. The reverberation times measured directly from the decay of the impulse response are slightly lower than those produced by the decay of a stationary noise and do not coincide with the Sabine's definition.

Schroeder's Integral

Schroeder (1965) demonstrated that the decay defined by Sabine can be obtained from the impulse response calculating the integral of the response itself. Such an integral must be calculated on the square of the impulse response, moving backward from the end of the decay up to the instant when the impulse was received.

Particular attention must be given to the choice of the start time for the integration. Indeed, by choosing too long a time, that is to say, longer than the decay interval of the sound level, an integrated decay curve will be obtained that will show an imaginary double gradient caused by the integration of the background noise. In contrast, by choosing a time too close to the beginning, that is to say, near to the instant when the impulse was received, the measurement dynamic will be reduced, which is useless. The ideal choice is the right compromise between maximizing the decay length and minimizing the effect of the background noise.

Consequently, the measurement of the background noise is extremely important when using the impulsive source technique, and must be measured with the maximum care in order to avoid completely distorting the measurement of the reverberation time.

Delta Ohm's sound level meter HD2010UC/A can automatically perform the backward integration of Schroeder by applying advanced numeric techniques to remove the undesirable effects of the background noise.

In the case where two different gradients of the integrated decay curve can be identified, the two relevant estimated reverberation times can be reported from the slope of the respective decay segments, which must be at least 10 dB each.

Early Decay Time EDT

In addition to the traditional reverberation time, starting from the integrated impulse response, the **Early Decay Time EDT** can be obtained from the first 10dB of the decay itself. Compared to the traditional reverberation time T correlated to the physical properties of the measured environment, the EDT is correlated with the subjective perception of the reverberation, and is therefore useful to evaluate the dependence of the EDT/ T ratio on frequency in the different points of the environment.

OPERATING PROCEDURE FOR REVERBERATION TIME MEASUREMENT

In this chapter we will describe the steps needed to measure the reverberation time.
Turn on the sound level meter and enter the program selection mode by pressing **PROG**:

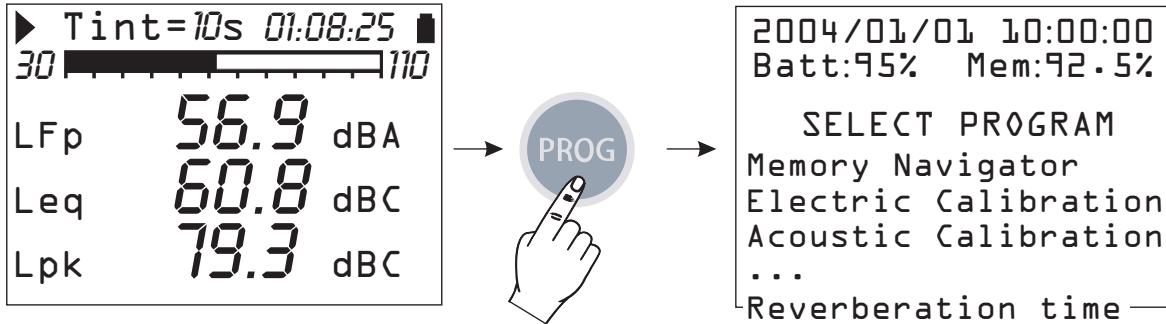

By using the arrows select the program "Reverberation Time" and confirm with **ENTER**³.

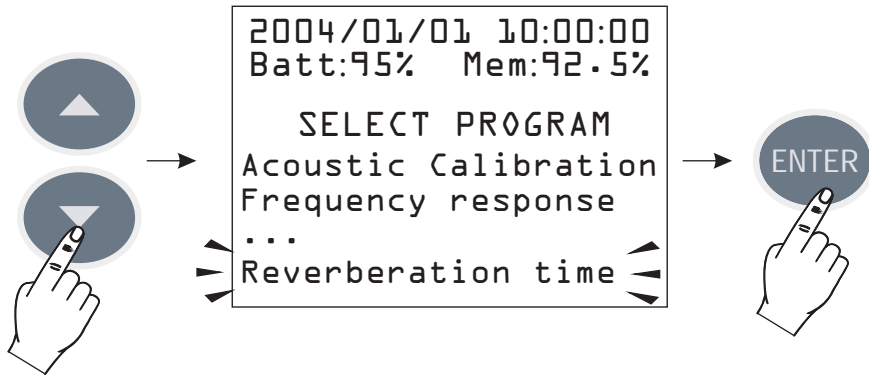

The program must be loaded into the memory: to continue, press the left arrow of the display keyboard (**YES**) and, on the next page, press the right arrow corresponding to **CONTINUE**.

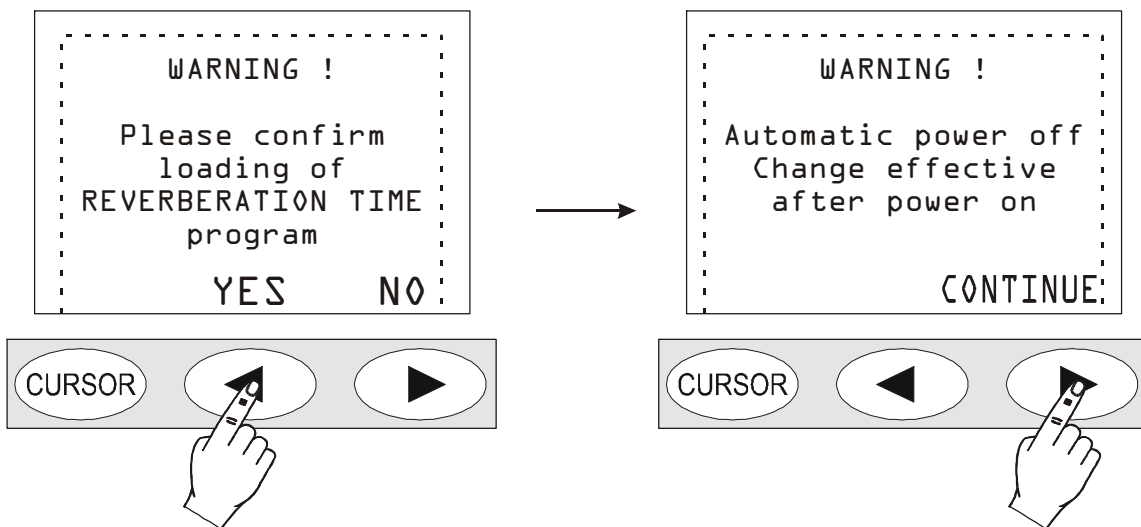

The sound level meter will automatically turn off.

³ If the option to measure the reverberation time is not present, a warning message will appear: "Program not enabled. Please contact the manufacturer". In this case you need to contact your vendor to purchase this feature.

Turn it back on with the **ON/OFF** key: a written confirmation of the activation of the reverberation time measurement program will appear.

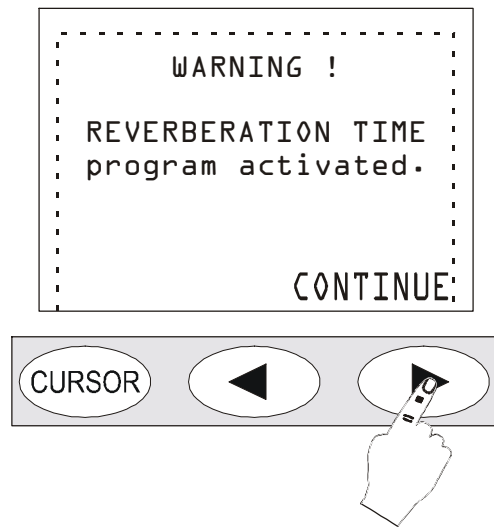

The page that now appears is the basic page:

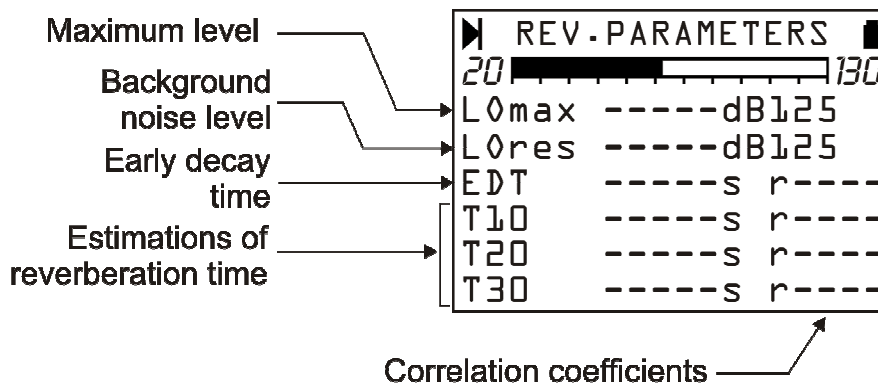

From top to bottom are shown: the maximum level in octave bands reached by the noise source (LO max), the background noise level in octave bands (LO res), the Early Decay Time EDT and the three estimations of the reverberation time T₁₀, T₂₀ and T₃₀ each with the correlation coefficient "r".

Before starting the reverberation time measurement, it is convenient to verify the source sound level and perform any preliminary investigation in order to set the noise generator to measure the reverberation time. The Profile view shows 8 times per second the maximum equivalent level integrated every 1/32s. The parameter can be selected for the octave and third of octave bands (**optional on 2010UC/A**). In the views concerning the frequency spectrum, two spectra per second are displayed as maximum band levels linearly integrated every 1/32s. The page of the six numeric parameters is not active until the reverberation time has been measured. When the source level has been verified and the signal/noise ratio is sufficient, the reverberation time measurement can be started. The sound level meter guides the user through the whole measurement procedure by means of messages on the display.

The sound level meter and the noise source must be set up (impulsive or continuous according to the type of measurement selected) and, when ready, continue by pressing the **PROG** key.

Measurement of the background noise

The first step involves the measurement of the background noise without any other noise sources: when ready press the GO key.

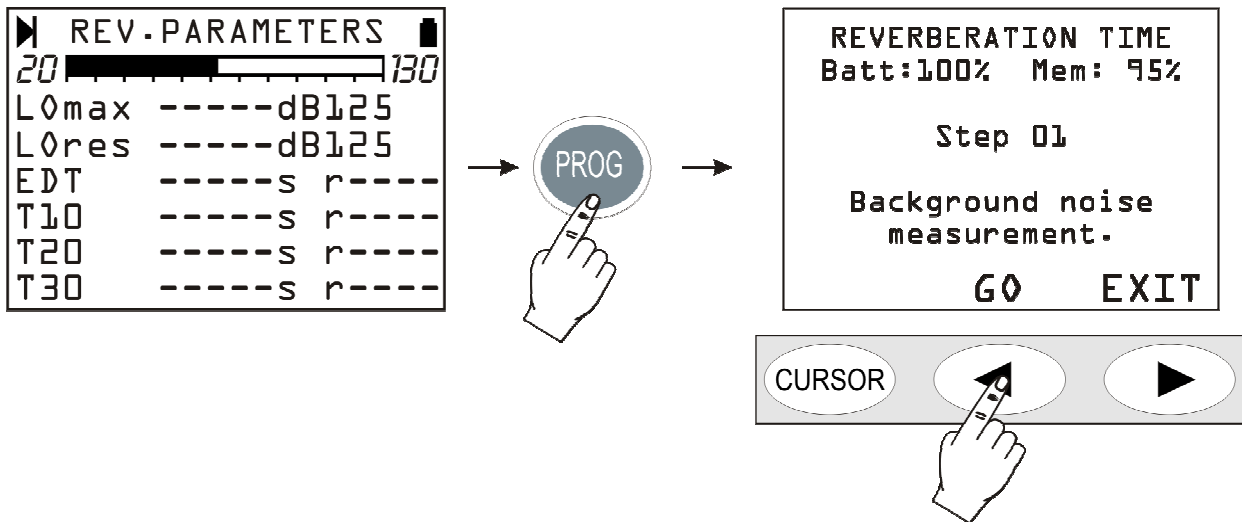

The current noise level is recorded and integrated for two seconds and then saved in the sound level meter internal memory.

In the next step (04) the type of noise source that will be used for the measurement is chosen: continuous noise source (NOISE) or impulsive source (IMPULSE). According to your choice, the measurement session will proceed in two different ways: first, the sound source interruption technique will be illustrated, and then the integrated impulse response.

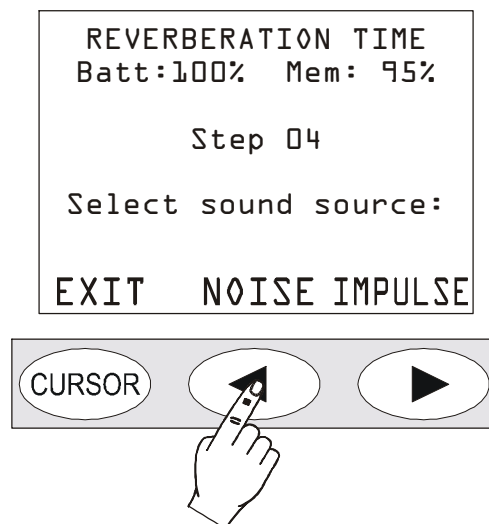

Sound source interruption

If you use the **continuous sound source interruption**, press the central **NOISE** key.

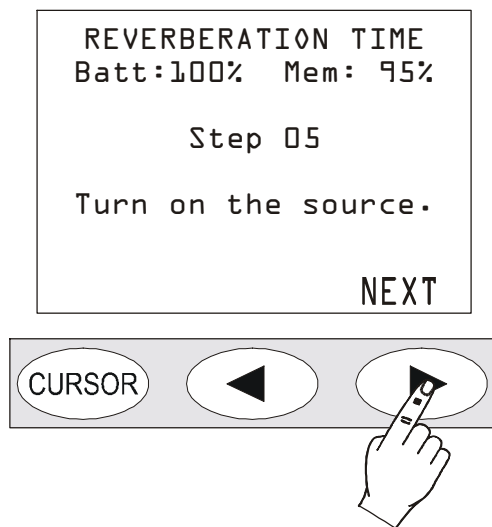

Activate the sound source and press the NEXT key.

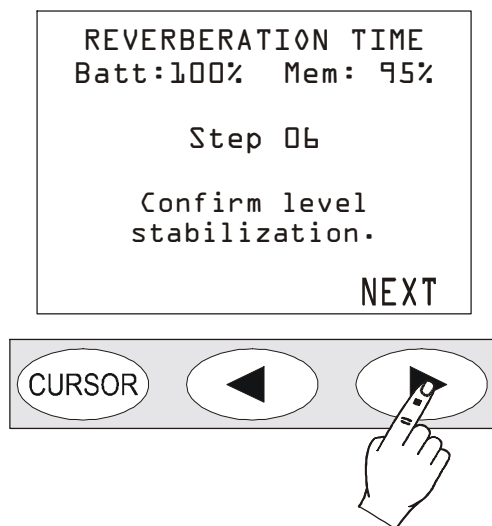

Wait until, according to the environment dimensions, the sound of the source stabilizes. Usually 4-5 seconds are enough even for wider environments, then proceed pressing the NEXT key.

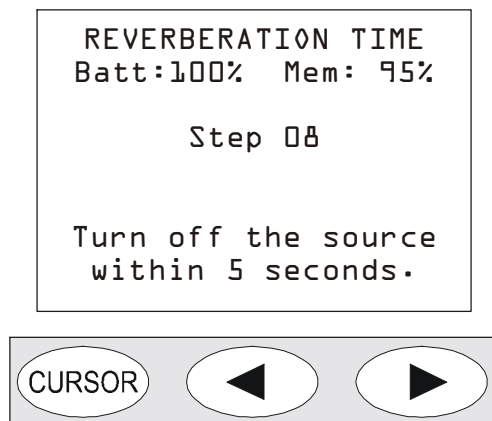

Now turn the sound source off **within 5 seconds**: the sound level meter will automatically measure the environment noise decay and will perform the calculations. For the entire duration of the measurement (6 seconds from the source being turned off) avoid undesired noises that could affect the measurement. The following page will appear at the end:

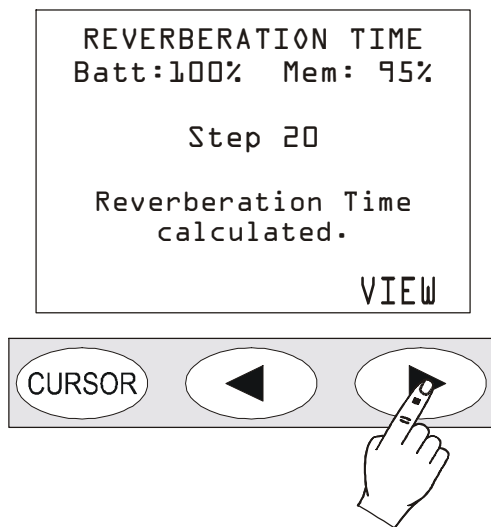

Press VIEW to display the results of the measurement.

REV. PARAMETERS	
20	130
L0max	105.2dB125
L0res	50.5dB125
EDT	----s r----
T10	0.91s r1.00
T20	0.95s r0.98
T30	0.94s r0.99

Using the sound source interruption method, the EDT value is not calculated in the measurement of the reverberation time.

The sound level meter gives a complete description of the measurement both in the form of a table and graphically. See the paragraph describing the results: *"Reverberation Time - Analysis of the Results"*.

Integrated Impulse Response

Using the integrated impulse response method, when at step 4, select *IMPULSE...*

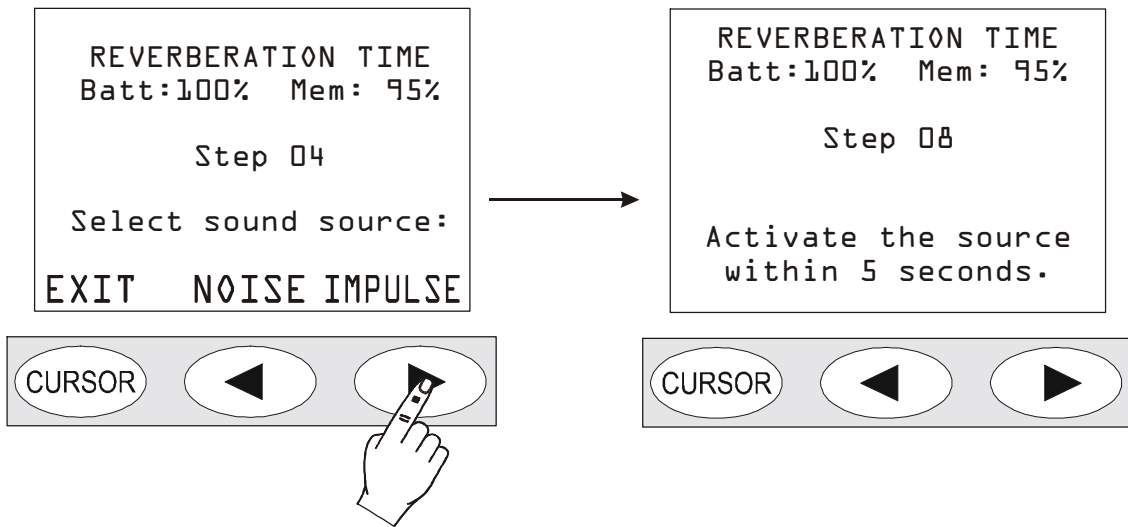

... and, as indicated in the next page, activate the impulsive noise sound source (gun shot, balloon explosion,...) **within 5 seconds** from pressing the button.

The sound level meter will automatically measure the environment noise decay and will perform the calculations. For the entire duration of the measurement (6 seconds from the source being turned off) avoid undesired noises that could affect the measurement. The following page will appear at the end:

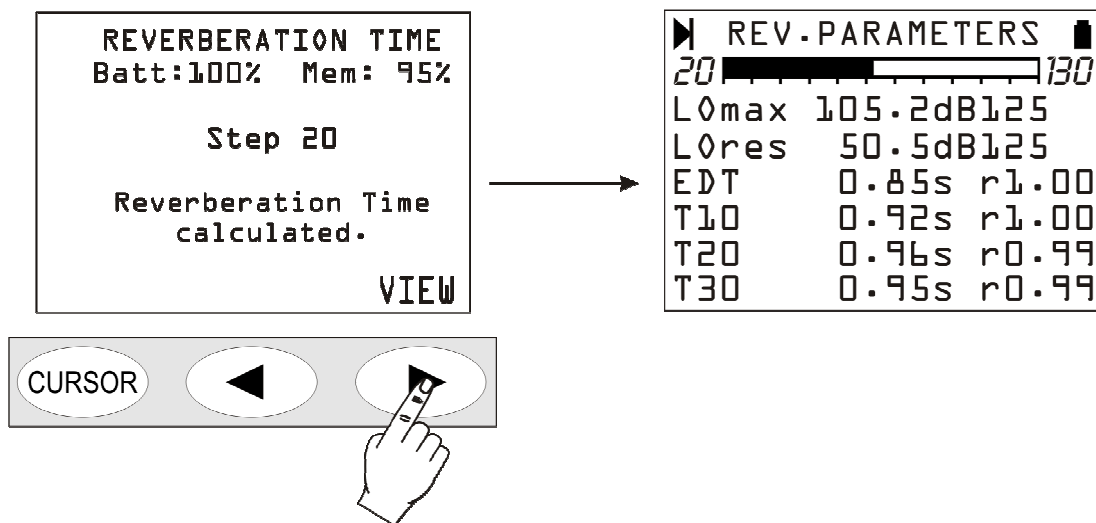

The sound level meter gives a complete description of the measurement both in the form of a table and graphically. See the paragraph describing the results: "*Reverberation Time - Analysis of the Results*".

Press the **PROG** key to access the next step where you can save (*SAVE* key), review the values again (*VIEW* key) or close the current measurement session to start a new one (*EXIT* key).

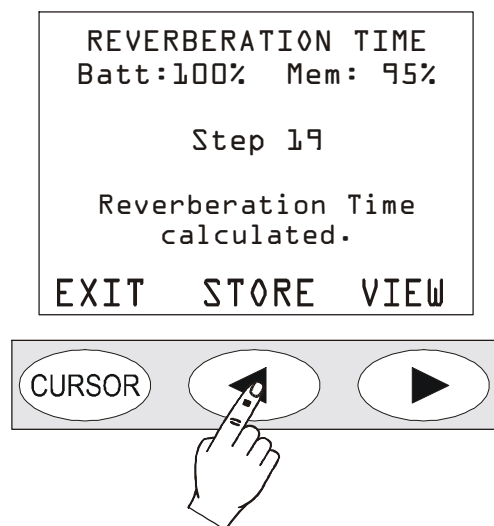

To restore the standard SLM mode of the sound level meter and to exit the reverberation time measurement program, turn off the instrument (ON/OFF button) and then turn it back on.

Measured not correctly performed

The measurement procedure is terminated if the maximum delay of 5 seconds is not satisfied for the generation of the impulsive noise or the continuous source turn off; the following message appears:

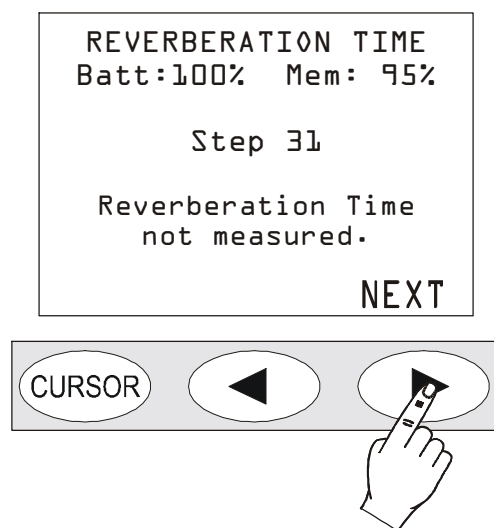

The same message is displayed if the signal/noise ratio between the generated signal and the background noise is not large enough.

Besides, one or more results may be missing if the signal/noise ratio between the generated signal and the background noise is not sufficient to perform the respective reverberation time estimations, as shown in the following page.

REV. PARAMETERS	
20	130
LOmax	90.5dB125
LOres	65.5dB125
EDT	0.85s r1.00
T10	0.92s r0.96
T20	-----s r----
T30	-----s r----

Reverberation time – Analysis of the results

At the end of the measurement, as indicated above, the results are supplied in a table or graphically.

Parameters

Pressing the right arrow on the display keyboard corresponding to the VIEW key brings the table up onto the screen.

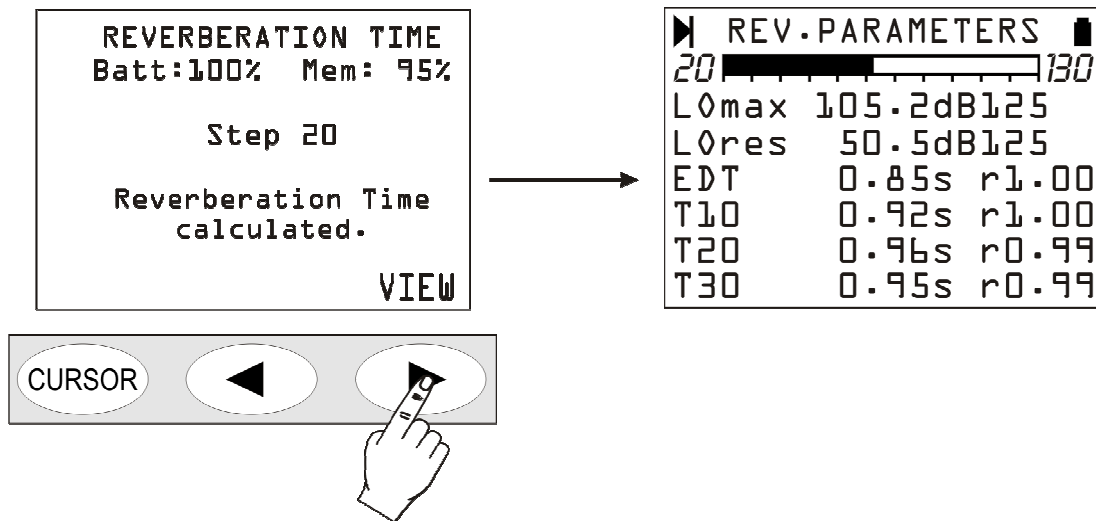

From top to bottom are shown the maximum octave band level reached by the noise source (LO max), the octave band background noise level (LO res), the first decay time EDT and the three estimations of the reverberation time T_{10} , T_{20} and T_{30} each with the correlation coefficient “r”. The results of the measurement refer to the variable indicated in the first two lines of the table (LOmax and LOres in the picture above). To display another variable, press the ENTER button: the current variable starts blinking. Using the arrows select the new variable from those available:

- LO: sound pressure level in octave bands from 125Hz to 8KHz
- LTO: sound pressure level in third octave bands from 100Hz to 10KHz (if third octave option is installed).

Pressing the right arrow, it's possible to select the central frequency of the filter allowing to modify their value. Pressing the left arrow returns to the selection of the parameter to be displayed.

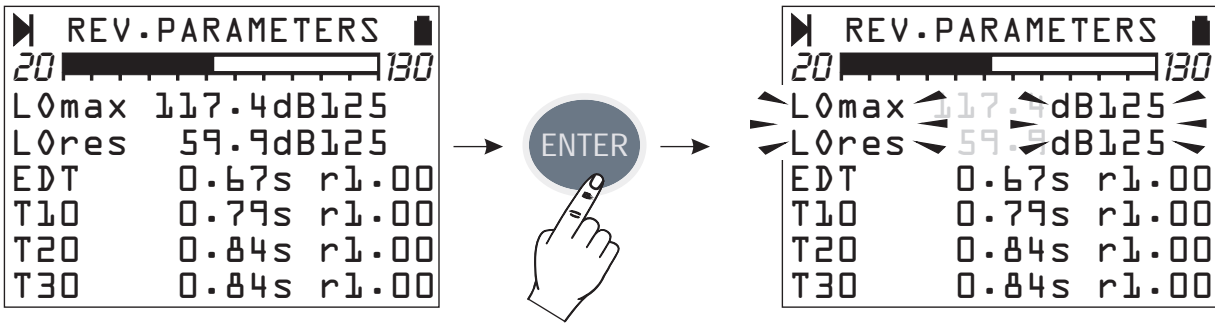

Confirm the selection by pressing the ENTER key. The sound level meter will calculate the new values and update the page showing the results.

To move from the table of the results to the graphs (profile, octaves and thirds of octave) repeatedly press the **MODE** button: as indicated below, by pressing this key the display will move to the time profile view, to the octave spectrum, to the third of octave (optional on **HD2010UC/A**) one and then return to the results.

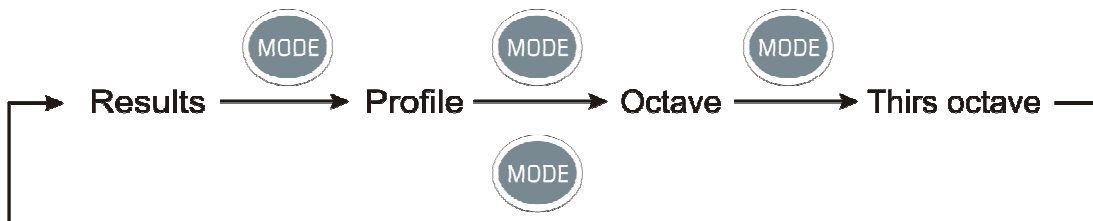

Profile

The **Profile** view shows the time trend of the acquired sound level. If you used the impulsive source method the graph shows Schroeder’s integral of the sound level acquired.

The following picture shows an example of a time profile obtained using the impulsive source method.

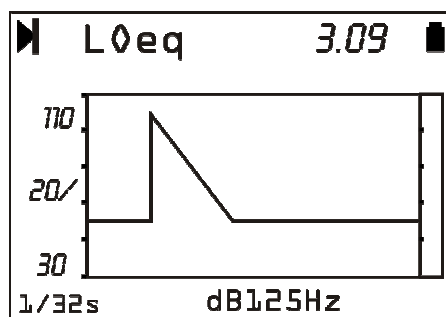

The upper number on the right (3.09) indicates the time in seconds in correspondence of the right border of the visible window of the graph. When the cursors are **not** active, you can move the graph horizontally on the time axis using the arrows. This function helps examine the decay profile when the measurement is taken in wide spaces where the reverberation time is longer than three seconds.

The integration time (fixed at 1/32s) and the central frequency of the constant percentage bandwidth filter are shown below.

The parameter displayed (LOeq at 125Hz in the picture's example) is the same parameter which the parameters view refers to. Even here it is possible to select, using the ENTER button and the arrows, the parameter to be displayed. Upon confirmation with ENTER, the profile graph and the values displayed in the parameters view are updated.

The profile can be analyzed by using the **cursor**s. By repeatedly pressing the CURSOR button the cursors **L1** and **L2** are sequentially activated, and finally the two cursors **ΔL**. The cursor selected blinks and the relevant data appear on the display in the second line from the top. When they are active individually (L1 or L2), the display shows the noise level and the corresponding time in seconds. When they are both active in "tracking", the second line of the display shows in this order: the difference $\Delta L=L2-L1$ of the noise levels, the time interval between L1 and L2 and the reverberation time estimation calculated by interpolating the part of the decay between L1 and L2.

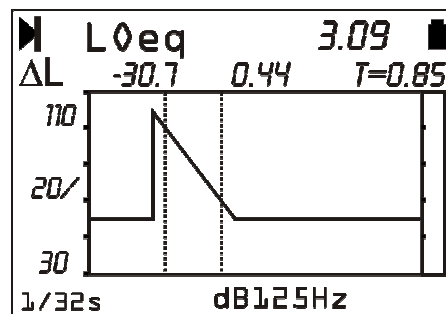

Reverberation time by octave and third of octave

By pressing the **MODE** key once, the display shows the estimation of reverberation time by octaves soon after the results view. Pressing the **MODE** button again you can see the estimation by the third of octave bands (optional on HD2010UC/A).

The spectrum by octave bands shows the reverberation times T_{10} , T_{20} , T_{30} and the early decay time EDT for each band from 125 Hz to 8 kHz, and the spectrum by third of octaves from 100 Hz to 10 kHz. The times are expressed in seconds.

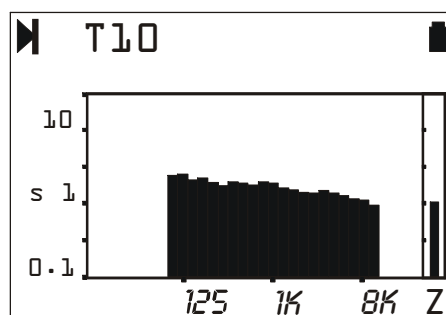

The variable (T_{10} , T_{20} , T_{30} or EDT) are selected as usual by **ENTER** and the arrows: upon confirmation by pressing **ENTER**, the page is refreshed to show the new results.

The **CURSOR** button activates the cursors: the following data are reported when the component is selected on the graph by the blinking cursor (RT@100 Hz in the following example): the reverberation time estimation and the respective correlation coefficient.

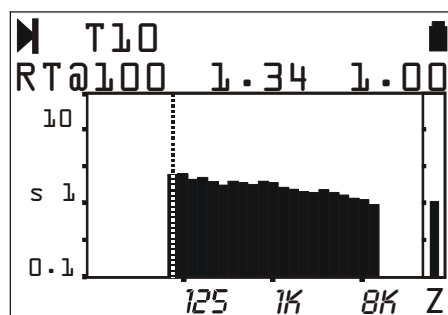

Display and printing of the results

The set of results obtained with the analysis of the reverberation time can be sent to a PC, connected via the special serial cable supplied with the device. A standard communication software (e.g. HyperTerminal) can be used to receive the data. The chapter "*SERIAL INTERFACE*" explains how to connect to a PC, the download of the data and their storage into a file.

In addition to the values acquired as a table, all the main characteristics of the sound level meter and measurement conditions are supplied.

A deeper analysis of the results can be performed by using the **Noise Studio** program supplied free of charge with the sound level meter. This software displays, processes, prints and exports the data stored in the sound level meter using the *SAVE* command (**PROG >> SAVE**) both as tables and as 2D and 3D graphs. The post-processing module (available as an option) NS3 of Noise Studio package allows to download, display and analyse the reverberation time measurements stored in the sound level meter memory. Specific functions to analyse and correct the reverberation time decay curves and to calculate absorption, airborne sound insulation and impact noise are implemented in NS3 software module.

Please see program's online Help menu for the details.

Important: with the saving operation (**SAVE** key), the current measurement session is closed and the sound level meter is set up for a possible new session. By using the *Navigator* feature (**PROG >> Navigator**), it is possible to review the measurement sessions saved, directly on the sound level meter display, but with some limitations: compared to the open session, the parameter results and time profile views **cannot be displayed**.

To display the different estimations (EDT, T_{10} , T_{20} and T_{30}) of the reverberation time for the octave and third of octave bands **optional on HD2010UC/A** just press the **MODE** key repeatedly.

Direct printing of results, pressing the **PRINT** button, is active for the saved sessions too.

FIRMWARE UPDATE

The firmware, that is the program managing all of the instrument functions, can be upgraded by transferring the file from a PC to the HD2110C/A through the serial/USB port. In this way, all the instrument functions can be upgraded.

To make the upgrade, you need to use Noise Studio “firmware upgrade” function. See “Noise Studio Handbook” online help for details.

OPTIONS UPGRADE

Instrument options (**HD2010.O1** “Third Octaves” and **HD2010.O4** “Reverberation Time”) can be bought and installed also after sound level meter initial purchase; they can be directly activated by the user using the Noise Studio software. Alternatively, it’s possible to send the instrument to Delta Ohm for upgrade.

To activate the specific option can be used the “Option Upgrade” function in Noise Studio along with the activation code supplied after option purchase. Please see the online Noise Studio Handbook for details.

Note: option **HD2010.O1** “Third Octave” requires the laboratory Calibration of filters and can normally installed at Delta Ohm technical department.

BATTERY MANAGEMENT

The battery symbol  in the upper right corner of the display constantly provides the charge status of the instrument batteries. The more the batteries discharge, the more the symbol gets “empty”:



When the battery voltage reaches the minimum value for a correct operation, the symbol flashes. At this point, only 5 minutes of autonomy are left and batteries should be recharged as soon as possible (the instrument uses a 4.8 V / 2.1 A NiMH battery pack).

If the instrument is still used, the battery voltage will decrease still further and the instrument cannot ensure anymore a correct measurement; data recording is automatically interrupted, as well as data logging and the instrument goes into STOP mode. Under a given level, the instrument will automatically shut off. Data stored on memory will remain. The instrument cannot be switched on again until the battery level remains low.

The battery charge level is available on the menu main screen and on the program screen, expressed as a percentage value. Press MENU or PROG to view it. When the level is indicated by 0%, 5 minutes of autonomy are left.

Note: the battery symbol also flashes when the auto power-off is disabled (AutoPowerOFF = OFF).

Recharging the batteries:

To recharge the batteries, connect the external power supply to the power socket (point 15 on page 5). The battery symbol changes into a mains plug when the instrument is connected to an external power supply.

The batteries can also be recharged by setting the serial port of the instrument in USB mode and connecting the instrument to the PC via the HD2110USB cable. **Charging via USB requires the instrument to be switched on: the batteries are not recharged via USB if the instrument is switched off.** Charging via USB is slower than charging via an external power supply.

Replacement of the batteries:

If the autonomy of the fully charged batteries is no longer sufficient, they must be replaced. To replace the batteries:

1. Switch the instrument off.
2. Unscrew the closing screw of the battery compartment cover.
3. Remove the battery pack. To extract the connector, pull the wires upwards near the connector.

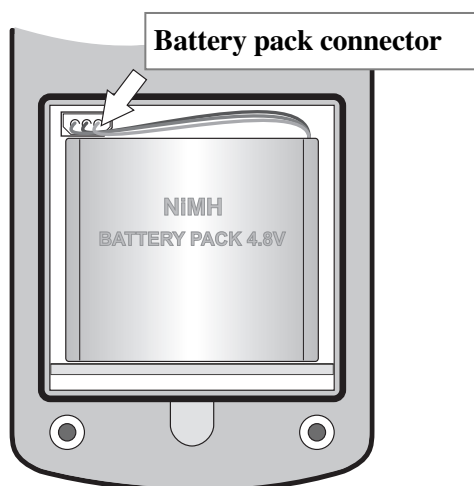

4. Insert the connector of the new battery pack (ordering code of the spare pack BAT4V8NIMH). The connector has a reference that prevents a wrong insertion. To fully insert the connector, push it with a pointed non-metallic object (e.g. a pencil or the cap of a pen).
5. Verify that the instrument turns on by pressing the ON/OFF key. If the instrument does not turn on, disconnect the battery pack and wait a few minutes before reconnecting it (when the battery pack is reconnected, the instrument should turn on automatically).
6. Place the new battery pack in the battery compartment taking care that the wires are not pinched.
7. Close the battery compartment cover.

Check date and time after replacing the batteries. If this operation takes less than two minutes, no clock adjustment should be needed.

WARNING ABOUT THE USE OF BATTERIES

- When the instrument is not used for a long time, remove the batteries and store them in a cool and dry place.
- Avoid loss of liquid from batteries.
- Use waterproof and good-quality batteries.
- If the instrument does not turn on after battery replacement:
 - Remove the batteries.
 - Wait at least 5 minutes for the sound level meter internal circuits to discharge.
 - Connect the batteries. If the batteries are charged, the instrument should turn on automatically.

Rechargeable batteries:

- When using for the first time, fully recharge the batteries.
- New batteries only reach full performance after they have been fully discharged and recharged at least two or three times.
- Batteries discharge themselves over time, even if not used.
- The batteries can be charged and discharged hundreds of times, but with use they lose capacity. If the autonomy of fully charged batteries is no longer sufficient, they must be replaced.
- Do not use charging devices incompatible with the type of battery.
- Batteries last longer if, from time to time, a complete discharge and charge cycle is performed.
- Do not overcharge the batteries by letting them charge for a long time after reaching full charge.
- Do not expose batteries to high temperatures.

Disposal of batteries:

- Dispose of dead batteries in the dedicated bins or deliver them to authorized collection centers. Follow the relevant regulation.
- Do not dispose as household waste.
- Do not throw batteries into fire.

INSTRUMENT STORAGE

Instrument storage conditions:

- Temperature: -25...+70°C.
- Humidity: less than 90% R.H. no condensation.
- To be avoided:
 1. High humidity storage.
 2. Direct sun irradiation over the instrument.
 3. High temperature source near the instrument.
 4. Presence of strong vibrations.
 5. Steam, salt and/or corrosive environments.

The instrument case is in ABS plastics material and the protection belt in rubber: do not use any solvent for cleaning.

SERIAL INTERFACE

The instrument is provided with a versatile serial interface with double protocol: RS232C and USB. The interface settings depend on the item “MENU >> Instrument >> Input/Output >> Serial Disp.”:

- **PRINTER:** connection with RS232 interface of the portable serial printer.
- **MODEM:** connection with RS232 interface to a modem.
- **RS232:** connection with RS232 interface to a PC equipped with COM type physical port.
- **USB:** connection with USB interface to a PC where the VCOM driver is installed.

The RS232 setting allows to connect the sound level meter to a COM type physical port of a PC. This connection does not need any particular program to work as it is allowed by the common architecture of PC equipped with RS232 (COM) port. The maximum speed of data transfer is up to 115200 baud.

In the last few years, in order to meet the needs of the new audio and video peripherals, the USB standard has been used for information serial transfer. Recently many PC manufacturers do not offer the COM type ports any longer, which are usually replaced by the USB type ports. There is a 4 wire connection, two wires for information transfer, other two wires for the power supply. As far as the data transfer is concerned, the main differences with respect to the RS232 interface RS232 are:

- The transfer occurs in simplex mode, i.e. it's impossible to carry out simultaneously a transfer in both the directions
- The data are transferred as package size
- The transfer time is defined by only one of the two units (the master)
- The transfer speed is fix at 1.5Mbit/s, 12Mbit/s or 480Mbit/s according to the USB standard and the kind of connected device.

The two devices connected through the USB interface are identified as master and slave. The master supplies power to the slave and decide the sense and the transfer time scheduling.

The USB interface of sound level meter is a sort of slave and then it has to be connected to a USB master able to supply with the necessary power and to manage the communication.

The sound level meter HD2010UC/A is equipped with a serial connecting cable for PC with COM type ports (code **HD2110RS**) or USB (code **HD2110USB**).

The **HD2110/RS** cable is a *null-modem* cable with 9-way sub D female connector. The HD2110USB cable is fitted with an USB connector type A. On request, the connection cable for modem or printer (DCE) with a 25-way sub D male connector (code **HD2110CSM**) or with a 9-way sub D male connector (code **HD2110CSP**) can be supplied.

When the item “MENU >> Instrument >> Input/Output >> Serial Device” is set on “PRINTER”, “MODEM” or “RS232”, the following signals are connected to the 8 pin male connector type M12 available on the instrument:

Pin	Direction	Signal	Description
1	Input	CTS	Clear to send
2	Output	DTE	DTE ready
3	Input	DCE - CD	DCE ready – Carrier detect
4	Output	VDD	Power supply 3.3V
5	Input	RD	Receiving data channel
6	Output	RTS	Request to send
7	Output	TD	Transmitting data channel
8	-	GND	Reference ground

The following signals are connected to the 9 pin sub D male connector of the HD2110RS cable:

Pin	Direction	Signal	Description
1	DCE >> HD2010UC/A	DCE - CD	DCE ready – Carrier detect
2	DCE >> HD2010UC/A	RD	Receiving data channel
3	HD2010UC/A >> DCE	TD	Transmitting data channel
4	HD2010UC/A >> DCE	DTE	DTE ready
5	-	GND	Reference ground
7	HD2010UC/A >> DCE	RTS	Request to send
8	DCE >> HD2010UC/A	CTS	Clear to send
9	HD2010UC/A >> DCE	VDD	Power supply 3.3V

When the item “MENU >> Instrument >> Input/Output >> Serial Device” is set on “USB”, the following signals are connected to the 8 pin male connector type M12 available on the instrument:

Pin	Direction	Signal	Description
2	I/O	DP	Data +
4	I/O	DM	Data -
6	Input	VBUS	Power supply 5V
8	-	GND	Reference ground

When the sound level meter is connected via RS232 to an active terminal (DCE active) the auto power off is disabled and the instrument cannot be switched off. If the instrument is off, the connection to an active terminal (DCE active) will turn it on.

Standard parameters of the instrument serial transmission are:

- Baud rate 38400 baud
- Parity None
- N. bit 8
- Stop bit 1
- Protocol Hardware.

Data transmission speed can be changed through the "*Baud rate*" parameter inside the menu - (MENU >> Instrument >> Input/Output >> RS232 Baud Rate – see page 39). Available baud rates are: 230400, 115200, 57600, 38400, 19200, 9600, 4800, 2400, 1200, 600, 300. The other transmission parameters are fixed.

The 2010UC/A is provided with a complete set of commands to be sent via the RS232 serial port of a PC.

COMMUNICATION PROTOCOL

The command consists of ASCII strings with a variable length, ending in CR-LF.

The instrument provides always a response, after a command has been received; if the command is not accepted, the response string is always NAK-CR-LF. It is possible to disable the response, when it is not expressly requested by the command, modifying the VERBOSE setup parameter (see the SET paragraph).

Commands are divided into 5 groups, as shown in the following table.

Group	N. of Commands	Description
SET	65	SETUP: parameter configuration
KEY	21	KEY: keyboard simulation
STT	4	STATUS: instrument status
DMP	6	DUMP: memory dump

Each group contains a given number of commands. Each command is identified by a specific string. The generic syntax of a command is the following:

<group>:<command>:<value>:CR-LF

Ex.: "SET:INPUT_GAIN:10\r\n"

sets the INPUT_GAIN parameter to 10dB (see SET paragraph).

Only capital characters are acknowledged. Each token can be shortened at the minimum number of characters that univocally identify it. The example can be shortened as follows:

"SET:INP:10\r\n"

Here are the possible command formats:

A3 - SET:INTEGRATION_TIME:<{SS,MM,HH}>:<value>CRLF

A4 - SET:TIME:<hh>:<mm>CRLF

A5 - SET:DATE:<yyyy>:<mm>:<dd>CRLF

A6 - SET:x_SLM_PARAMETER:<Parameter abbreviation>:<parameter attribute>CRLF

A7 - SET:PROFILE_PARAMETER:<Parameter abbreviation>:<parameter attribute>CRLF

A8 - SET:<COMMAND>:<value>CRLF

A10 - SET:<COMMAND>:?CRLF

C1 - KEY:<COMMAND>CRLF

C2 - KEY:<COMMAND>:<value>CRLF

D1 - STT:<COMMAND>:<OPTION>CRLF

E1 - DMP:<COMMAND>CRLF

If you enter "?" properly in the string, you can get either a help for the compilation of the desired command or the current status of the instrument configuration parameters. Here are the formats of the commands that use the "?" character.

0 ?CRLF

Provides the list of the groups of commands

A9 SET:?CRLF

Provides the command list of the SET group

A10 SET:<COMMAND>:?CRLF

Provides the current status of the specified command

C3 KEY:?CRLF

Provides the command list of the KEY group

D2 STT:?CRLF

Provides the command list of the STT group

D3 STT:<COMMAND>:?CRLF

Provides the current status of the specified command

E2 DMP:?CRLF

Provides the command list of the DMP group

SET Group (SETUP)

The following table shows the list of the commands of the SET group (SETUP)

Command	Format	Description
INSTR_MODEL	A10	Instrument model - UNMODIFIABLE
INSTR_NUMBER	A10	Instrument serial number - UNMODIFIABLE
INSTR_VERSION	A10	Instrument version - UNMODIFIABLE
MIC_MODEL	A10	Microphone model – UNMODIFIABLE
MIC_NUMBER	A10	Microphone serial number – UNMODIFIABLE
MIC_TYPE	A10	Type of microphone – UNMODIFIABLE
CLASS	A10	Class of tolerance – NON MODIFICABILE
MEM_SIZE	A10	Memory size – UNMODIFIABLE
OPTIONS	A10	Firmware options – UNMODIFIABLE
EXT_RNG	A10	Extended range – UNMODIFIABLE
TIME	A4	Time (hh:mm)
DATE	A5	Date (yyyy/mm/dd)
DISP_CONTRAST	A8	Display contrast (3÷9, default: 5)
AUTO_POWEROFF	A8	Instrument auto-power-off (ON/OFF, default: ON)
BAUD_RATE	A8	Baud rate RS232
DEVICE	A8	Serial device
INPUT_GAIN	A8	Input gain
INTEGRATION_TIME	A3	Integration time in s, m (1÷59) or h (1÷99)
REPORT_TIME	A8	Report Time
ERASE_TIME	A8	Erase interval
EXCHANGE_RATE	A8	Exchange rate in dB (3÷5)
DOSE_THRESHOLD	A8	Dose threshold in dB (0÷140)
CRITERION_LEVEL	A8	Criterion level in dB (60÷140)
VERBOSE	A8	Acknowledge (ON/OFF, default: ON). Always ON upon power on.
OVERLOAD_LEVEL	A8	Overload level in dB (20÷200)
INT_MODE	A8	Integration Mode
1_PERC_LEVEL	A8	Percentile level 1 in % (1 ÷ 99, default: 1)
2_PERC_LEVEL	A8	Percentile level 2 in % (1 ÷ 99, default: 10)
3_PERC_LEVEL	A8	Percentile level 3 in % (1 ÷ 99, default: 50)
4_PERC_LEVEL	A8	Percentile level 4 in % (1 ÷ 99, default: 90)
1_SLM_PARAMETER	A6	SLM parameter 1 (see parameter list)
2_SLM_PARAMETER	A6	SLM parameter 2 (see parameter list)
3_SLM_PARAMETER	A6	SLM parameter 3 (see parameter list)
SPECT_AUX_POND	A8	Spectrum auxiliary weighting
STAT_PARAMETER	A6	Parameter for statistical analysis
EVN_TRIGGER	A8	Event trigger source
EVN_ON_LEVEL	A8	Trigger activation level in dB (10 ÷ 140, default: 90)
EVN_OFF_LEVEL	A8	Trigger deactivation level in dB (10 ÷ 140, default: 60)
EVN_POLARITY	A8	Trigger level polarity (POS/NEG)
EVN_ON_TIME	A8	Trigger activation delay in seconds from 0 to 10
EVN_OFF_TIME	A8	Trigger deactivation delay in seconds from 0 to 255
EVN_PRINT	A8	Enabling event trigger printing
AUTO_STORE	A8	Enabling Auto-Store function (ON/OFF, default: OFF)
SLM+PROF_DLOGGER	A8	Continuous recording of SLM and PROFILE parameters (ON/OFF, default: ON)

Command	Format	Description
1_REP_PARAMETER	A6	REPORT parameter 1 (see parameter list)
2_REP_PARAMETER	A6	REPORT parameter 2 (see parameter list)
3_REP_PARAMETER	A6	REPORT parameter 3 (see parameter list)
4_REP_PARAMETER	A6	REPORT parameter 4 (see parameter list)
5_REP_PARAMETER	A6	REPORT parameter 5 (see parameter list)
REP_PARAMETERS	A8	Recording of REPORT parameters 1-5 (ON/OFF, default: OFF)
REP_OCTAVE	A8	Recording of Octave spectrum (ON/OFF, default: OFF)
REP_TOCTAVE	A8	Recording of Third Octave spectrum (ON/OFF, default: OFF)
REP_STATISTICS	A8	Statistical recording (ON/OFF, default: OFF)
1_EVN_PARAMETER	A6	EVENT parameter 1 (see parameter list)
2_EVN_PARAMETER	A6	EVENT parameter 2 (see parameter list)
3_EVN_PARAMETER	A6	EVENT parameter 3 (see parameter list)
4_EVN_PARAMETER	A6	EVENT parameter 4 (see parameter list)
5_EVN_PARAMETER	A6	EVENT parameter 5 (see parameter list)
EVN_PARAMETERS	A8	Recording of EVENT parameters 1-5 (ON/OFF, default: OFF)
EVN_OCTAVE	A8	Recording of Octave spectrum (ON/OFF, default: OFF)
EVN_TOCTAVE	A8	Recording of Third Octave spectrum (ON/OFF, default: OFF)
EVN_STATISTICS	A8	Statistical recording (ON/OFF, default: OFF)
CAL_LEVEL	A8	Acoustic calibrator level in dB (90.0 ÷ 130.0, default: 94.0)
MIC_CORR	A8	Acoustic range correction
WND_SHL_CORR	A10	Wind-shield correction (ON/OFF, default: OFF)
SEQ_TIMER	A3	Acquisition delay in s, m (1÷59) or h (1÷99)

The value that some parameters can take is listed in the following table (default value in bold print).

Parameter	Value
BAUD_RATE	300
	600
	1.2k
	2.4k
	4.8k
	9.6k
	19.2k
	38.4k
	57.6k
	115.2k
	230.4k
DEVICE	RS232
	MODEM
	USB
	PRINTER
INPUT_GAIN	0
	10
	20
	30
	40
ERASE_TIME	5s
	10s
	30s
	60s
REPORT_TIME	1s
	2s
	5s
	10s
	20s
	30s
	1m
	2m
	5m
	10m
	20m
	30m
	1h
	SPECT_AUX_POND
C	
A	
EVN_TRIGGER	OFF
	LEV
	MAN
MIC_CORR	FF
	RI
WND_SHL_CORR	OFF
	SAV
	WME
EVN_PRINT	OFF
	TAG

The parameters that can be displayed in SLM mode are selectable among the following ones:

Parameter	Attribute	Description
Lpk	Z or C	Instantaneous peak level, Z or C weighted
Lpkmx	Z or C	Peak maximum level
LeqS	Z, C or A	Short equivalent level, Z, C or A weighted
Leq	Z, C or A	Equivalent sound pressure level
LFp	Z, C or A	FAST sound pressure level
LSp	Z, C or A	SLOW sound pressure level
LIp	Z, C or A	IMPULSE sound pressure level
LFmx	Z, C or A	FAST maximum sound pressure level
LSmx	Z, C or A	SLOW maximum sound pressure level
LImx	Z, C or A	IMPULSE maximum sound pressure level
LFmn	Z, C or A	FAST minimum sound pressure level
LSmn	Z, C or A	SLOW minimum sound pressure level
LImn	Z, C or A	IMPULSE minimum sound pressure level
LeqI	A	Equivalent sound pressure level with Impulse time constant
LE	A	A weighted exposure level (SEL)
Dose	A	A weighted dose
Dose,d	A	A weighted daily dose
L1	A	Percentile level (calculated on FAST pressure level, A weighted)
L2	A	Percentile level
L3	A	Percentile level
L4	A	Percentile level
OL	-	Time percentage in which an overload has occurred

The attribute of parameters that can be displayed in SLM mode indicates the respective frequency weighting.

KEY GROUP

The following table shows the command list of the KEY group.

Command	Format	Description
LEFT	C1	LEFT key
MENU	C1	MENU key
PRINT	C1	PRINT key
PROG	C1	PROG key
PAUSE	C1	PAUSE key
RUN	C1	RUN key
UP	C1	UP key
MODE	C1	MODE key
RIGHT	C1	RIGHT key
ENTER	C1	ENTER key
DOWN	C1	DOWN key
HOLD	C1	ALPHA key
CURSOR	C1	HOLD key
CLEFT	C1	CURSOR key
CRIGHT	C1	CURSOR LEFT key
SER_MON	C1	CURSOR RIGHT key
STORE	C1	Simulates the PRINT key to be pressed for more than 2 sec
DATA_LOG	C1	Simulates the REC key to be pressed for more then 2 sec

Command	Format	Description
PRN_VAL	C1	REC+RUN key
EXEC	C2	PRINT key without printing the heading

STT GROUP (STATUS)

The following table shows the command list of the STT group (STATUS).

Command	Description
ACQUISITION	Acquisition control
DISPLAY	Display management
MONITOR	Monitor function via RS232
RECORDER	Recording management

The STT:ACQUISITION commands are provided in the following table.

Command	Format	Description
HOLD	D1	Interrupts display update
UPDATE	D1	Restarts display update
PAUSE	D1	Measurement in pause
RUN	D1	Starts measurements
STOP	D1	Ends measurements
CLEAR	D1	Clears measured levels
CONTINUE	D1	Restarts measuring
ERASE	D1	Erases the last x seconds of measurements
RECORD	D1	Starts and records measurements

The STT:ACQUISITION:? command provides information on the acquisition status as shown in the following example.

```
STT:ACQ:?
STT:ACQUISITION:STOP
BATTERY: 32%
MEMORY: 95.4%
DUMP TIME:00:00:01
LAST CALIBRATION: 2003/07/31 08:37
```

The STT:DISPLAY commands are listed in the table below.

Command	Format	Description
SLM	D1	Displays 5 selectable parameters in numeric format
PROFILE	D1	Displays the time profile of a selectable parameter
OCTAVE	D1	Displays the spectrum by octave bands
THIRD_OCTAVE	D1	Display the spectrum by one-third octave bands
PROB_DIST.	D1	Displays the level distribution of probabilities
CUMUL_DIST.	D1	Displays the percentile levels graph

The STT:DISPLAY:? command provides information relevant to the sound level meter actual display as shown in this example:

STT:DIS:?
 STT:DISPLAY:Mode:PROFILE

The following table lists the STT:MONITOR commands.

Command	Format	Description
ON	D1	Starts the Monitor function
OFF	D1	Ends the Monitor function
MEASUREMENT	D1	Monitor
SLM	D1	Monitor by 3 parameters
PROFILE	D1	Monitor by single parameter
OCTAVE	D1	Monitor of the spectrum by octave bands
THIRD_OCTAVE	D1	Monitor/Recording by third octave bands
REPORT	D1	Monitor of the reports
EVENT	D1	Monitor of the events

The following table lists the STT:RECORDER commands.

Command	Format	Description
ON	D1	Starts the Record function
OFF	D1	Terminates the Record function
AUTO	D1	Enables the Auto-Store function

STT:MONITOR:? and STT:RECORDER:? commands provide information on the monitor and recording status as shown in the following example.

STT:REC:?
 STT:RECORDER:Measurement:SLM:OFF

DMP GROUP (DUMP)

The table below features the list of the DMP group commands (DUMP).

Command	Format	Description
ON	E1	Starts memory dump
OFF	E1	Ends memory dump
NEXT_RECORD	E1	Requires the transmission of the next record
RECORD	E1	Requires the transmission of the current record
CLEAR	E1	Clears memory

Data download sequence is:

- DMP:ON\r\n
The heading ending in the string “MEMORY DUMP\r\n” is printed if there are any data on memory
- DMP:RECORD\r\n
Prints the previous record in binary format
- DMP:NEXT_RECORD\r\n
Prints the current record in binary format. If this is the last record, it prints the string “END OF DUMP\r\n”
- DMP:CLEAR\r\n (optional)

- Clears memory
DMP:OFF\r\n
Ends data dump

Data dump can be interrupted through the sequences:

- DMP:OFF\r\n
Ends data dump

CONNECTION TO A MODEM

A modem connection allows a remote control of the HD2010UC/A sound level meter. Optional **Noise Studio module “Monitor”** for PC, can fully manage the sound level meter not only via a simple RS232 serial connection or USB, but also, via the telephone line by means of two modems.

While the modem that connects the PC to the telephone line must not meet any particular requirement but being Hayes© compatible, the modem connected to the HD2110 sound level meter has to be configurable by the sound level meter itself and shall not interfere with improper messages during the delicate data transmission phase from the sound level meter to the PC. Delta Ohm s.r.l. suggests three types of modems to be used:

- Multitech MT2834ZDX
- Digicom SNM49
- Digicom Botticelli

The connection with these modems has been tested. Other modems might be used but, due to the great variety available on the market, we cannot provide service for the connection to modems other than those listed here.

The modem connected to the HD2010UC/A sound level meter must be configured before being used for data transmission. The configuration is carried out automatically by the sound level meter itself, according to the following steps.

1. Connect the modem to the HD2010UC/A by means of the **HD2110CSM** special cable with M12 connector.
2. Connect the modem to the telephone line and the power supply.
3. Switch on the modem.
4. Switch on the sound level meter.
5. Set the baud rate at 38400 baud at least via the parameter: MENU >> Instrument >> Input/Output >> RS232 Baud Rate.
6. Select MODEM as serial connection through the parameter: MENU >> Instrument >> Input/Output >> Serial Device.

The instrument automatically gets into the modem configuration mode. The successful configuration will be confirmed by the message “Modem Configured.” Should the configuration fail, the sound level meter will automatically switch to PC mode and the message “Configuration failed!” will be displayed.

When the modem is configured, it is possible to make the remote connection running **Noise Studio “Monitor”** module. Possible under voltages on the modem do not create problems as the configuration is memorized and automatically loaded on turning it on.

The table shows the HD2110CSM cable connections:

M12 connector (female 8-pole)	DB25 serial connector (male)
1	5
2	20
3	8
4	22
5	3
6	4
7	2
8	7

Connectors – front/external view

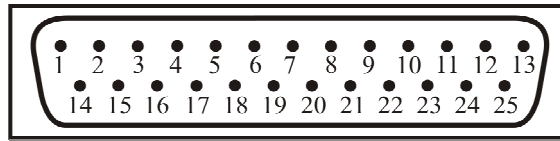

DB25

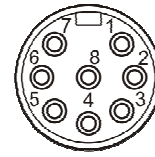

M12

CONNECTION TO A PRINTER

The HD2010UC/A sound level meter can print the levels displayed in a format compatible with a portable 24 column printer, such as the HD40.1.

Printer and sound level meter must be configured properly.

Sound level meter configuration

1. Set the parameter MENU >> Instrument >> Input/Output >> RS232 Baud Rate to: 38.4k
2. Set the parameter MENU >> Instrument >> Input/Output >> Serial Device to: PRINTER.

Printer configuration

1. The printer Baud Rate **must be the same** of the sound level meter (38400 baud).
2. Data bits: 8.
3. Parity: None
4. Stop bits: 1.
5. Handshaking: Xon/Xoff
6. Autofeed: Enabled.



Connect the HD2010UC/A sound level meter to the printer by means of the special **HD2110RS** cable.

Follow the instructions in the documentation supplied with the printer.

CONNECTION TO A PC WITH USB INTERFACE

The HD2010UC/A sound level meter fitted with USB interface can be connected to a PC's USB port by using the HD2110USB cable.

The USB port connection requires the previous installation of a driver contained in the Noise Studio software.

Before connecting the USB cable to the PC, install the Noise Studio software.

With the operating systems starting from Windows 7 it is necessary to boot the PC taking care to disable the request for “driver signature”, as explained in the USB driver installation guide included in the Noise Studio software installation package.

Proceed as follows:

1. Set the instrument menu item “MENU >> Instrument >> Input/Output >> Serial Device” to “USB”. Confirm and exit from the menu”.
2. **Do not connect the instrument to USB port until requested from the wizard**
3. Start the **Noise Studio** software installation package (in the operating systems starting from Windows Vista, click with right mouse key on file “*Autorun*” and select “*Run as administrator*”).
4. From starting window of Noise Studio click on “USB drive installation” to start the driver installation procedure.
5. The program checks the Windows® operating system version and copies related drivers in a temporary folder.
6. At the end a message appears asking to plug the sound level meter connection cable to PC USB port: press OK and close **Noise Studio** software pressing EXIT key.
7. **Connect the sound level meter to USB port and turn it ON:** when Windows recognise the instrument, it appears a message “*a new device has been detected*”.
8. Wait some seconds until the message “new hardware is installed and ready to work” appears.
9. Driver installation procedure is ended: whenever the instrument will be connected it will be automatically recognized.

Note: if the sound level meter has been connected to USB port **before USB driver installation**, in Windows 2000 and XP operating systems it appears the window “*new hardware installation*”. In Windows Vista and Windows 7 it appears an installation error under “device manager”: in both cases, cancel operation, disconnect instrument and restart the complete procedure starting from the beginning of this guide.

VERIFICATION OF PROPER DRIVER INSTALLATION

To verify the proper installation procedure, open the “Device Manager” section of the Control Panel of the PC.

Connect the instrument to the USB port.

The following items should appear:

- “Port (COM and LPT) >> USB Serial Port (COM#)”. **The value # is the number assigned to virtual serial port.**
- “*Controller USB (Universal serial bus) >> USB serial converter*”

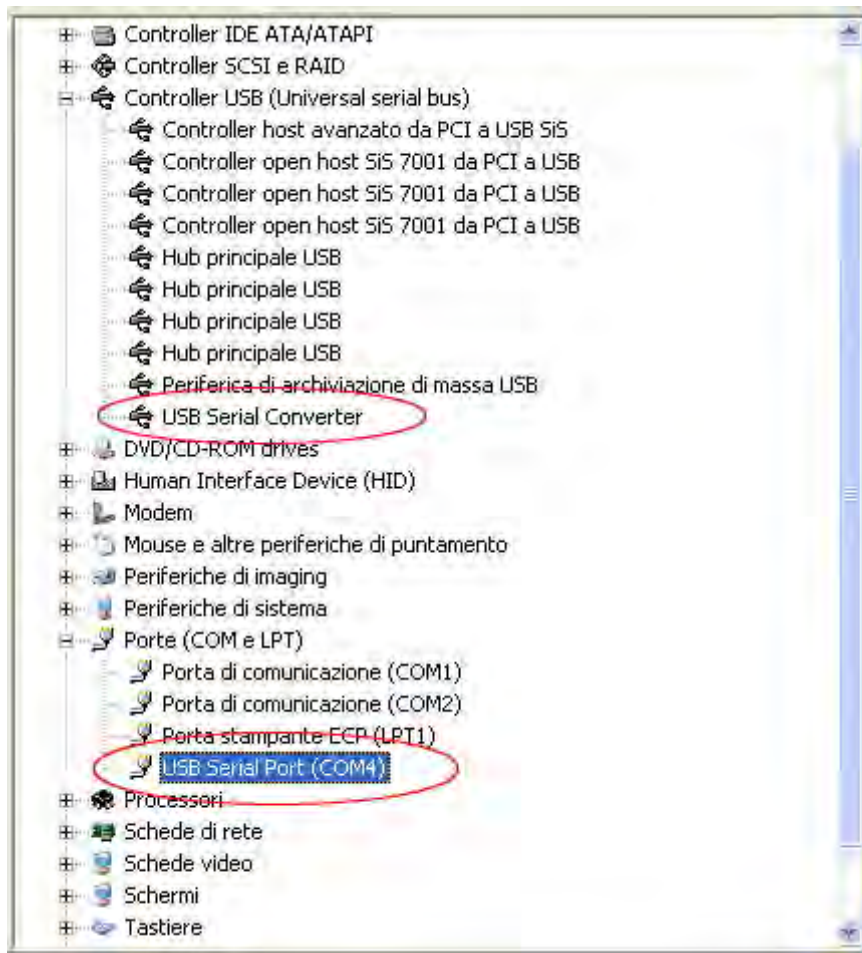

When USB cable is unplugged, the above items will disappear and they will appear again as soon as the instrument is plugged to USB port.

In the documentation supplied with the **Noise Studio** software installation package it is available a detailed version of the USB driver management guide. The steps to remove the USB driver are also included.

HD2010MC MEMORY CARD READER

The reader HD2010MC can be used on the sound level meters provided with M12 serial connection. Sound level meters not provided with M12 input, can be modified in order to be able to use the memory card reader HD2010MC.



DESCRIPTION OF THE INTERFACE FOR MEMORY CARD HD2010MC

The reader HD2010MC allows to expand the storage capacity of the sound level meter. By employing SD type or MMC card type, it is possible to record, for example, a sound level profile continuously for several months. In addition, it is possible to download data from the internal memory of the sound level meter to the card. This function can turn very useful when the effected measurements need to be downloaded without moving the device or without using a notebook.

The maximum storage capacity of the card is 2GB, the formatting is FAT16 type.

The reader is powered by the sound level meter and doesn't require any external power supply.

PREPARATION OF A NEW MEMORY CARD

Every new memory card needs to be formatted before use by means of the appropriate function of the Noise Studio software.

The formatting function requires the PC, on which the Noise studio Software has been installed, to be equipped with a PC Memory card reader (not included in supply). Those are typically included in most recent laptops and desktop computers. Optionally it is possible to use an external memory card, to be connected to an USB port.

How to format a memory card:

1. If the PC isn't provided with a SD/MMC card reader, connect an external device to the USB port of the PC.
2. Start up the Noise Studio software.
3. Press the key *Instrument management* in Noise Studio: press the key *Memory Card Formatting*.
4. Select the path of the card to be formatted and confirm with ENTER.
5. On the following screen, ensure that the parameter "File System = FAT" has been selected and press START: the card will be formatted.

6. When the message “Formatting completed” appears, press OK for confirmation and CLOSE to exit.
7. Close the Noise Studio software.
8. The formatting has been accomplished and the card is ready for use.

CONNECTION OF HD2010MC TO THE SOUND LEVEL METER AND USE OF THE MEMORY CARD

Connection of the HD2010MC:

1. Switch off the sound level meter .
2. Connect HD2010MC to the M12 connector of the sound level meter ensuring the correct fastening of the connector’s ring nut. **While inserting, please make sure that the arrow printed on the reader is turned upwards.** The reader has to be connected to the sound level meter in vertical position.



3. Insert the memory card in the slot of HD2010MC interface.
4. Switch on the sound level meter and set the menu item “MENU >> Instrument >> Input/Output >> Serial device ” on “MC”.
5. The sound level meter identifies the device. The display of the sound level meter shows “MC connected” and the remaining dimension of memory. The LED on the card reader signalizes the connection.
6. If the display visualizes “Connection failed”, check carefully if the memory card has been introduced correctly into the slot and if the connector is plugged in properly.

When HD2010MC interface is connected to the sound level meter, any recording is automatically sent to the memory card rather than to the internal memory of the sound level meter.

During recording, the LED on the reader flashes upon receipt of every data package.

When memory is used up entirely, the recording will be interrupted.

To disconnect HD2010MC interface from the sound level meter:

1. Switch off the sound level meter.
2. Disconnect HD2010MC interface.

NOTE: Slipping off the memory card while the sound level meter is running and interface is connected causes the loss of all data.

In order to replace the memory card, switch off the sound level meter.

For disabling HD2010MC temporarily:

Set the menu item “MENU >> Instrument >> Input/Output >> Serial device” on a different device than MC.

In order to re-enable the reader, set the menu item on “MC”.

FOR USING DATA DIRECTLY FROM PC

In order to read and copy files from the memory card to the PC, use a memory card reader for PC: the card will be recognized as external peripheral mass storage device.

Do not write, cancel or modify the files through the PC.

In order to cancel the memory card, use the formatting function (see chapter “*Preparation of a new memory card*”).

DATA TRANSFER FROM SOUND LEVEL METER TO MEMORY CARD

Data can be transferred from the internal memory of the sound level meter to the external memory by executing the sound level meter program “PROG key >> Data download to MC”.

This program allows copying of the measurements recorded in the sound level meter into the external memory card.

The program can be activated only after having connected the memory card interface HD2010MC, as described in the chapter “*Connection of HD2010MC to the sound level meter and use of the memory card*”.

During data download, which occurs automatically, the remaining memory space of the card and the

estimation of program completion time are displayed on the screen.

The data transfer from the sound level meter to the memory card **doesn't** delete the internal memory of the sound level meter. In order to delete the content of the internal data memory of the sound level meter, it is necessary to use the Navigator program.

To cancel the data of the card, use only the formatting function of Noise Studio: the erasure of single files contained in the memory card is not foreseen.

The Navigator program is not able to manage registrations which have been effected with external devices as interface for HD2010MC memory card.

TECHNICAL SPECIFICATIONS

Type of card	MMC and SD
Maximum capacity	2GB
Power supply	provided by sound level meter
Function indicator	LED on the reader
Connector	8-pole female M12

TECHNICAL SPECIFICATIONS

The HD2010UC/A sound level meter is a type 1 or 2 integrating sound level meter with frequency analysis by octave and third octave bands (**with “Third Octave” option**), as well as with statistical analysis.

HD2010UC/A complies with the following standards

- IEC 61672:2002-5 and IEC 61672-1 ed. 2.0 of 2013 Class 1 or Class 2 Group X
- IEC 60651:2001-10 Class 1 or Class 2
- IEC 60804:2000-10 Class 1 or Class 2
- IEC 61260:1995-8 Class 1 + Amendment 1:2001-09
- ANSI S1.4:1983 Type 1 or Type 2
- ANSI S1.11:1986 Order 3 Type 1-D Optional Range

Microphone Models

- **UC52**, ½ inch pre-polarized microphone with 20 mV/Pa sensitivity; frequency response optimized for Free Field.
- **MC24E** and **MC24EH**, ¼ inch with 2 mV/Pa (MC24E) or 0.25 mV/Pa (MC24EH) sensitivity, pre-polarized, optimized for free field measurements.

Preamplifier Models

For ½ inch pre-polarized microphones, with 20 mV/Pa sensitivity:

- **HD2010PNE2**: with connection for UC52, ½” microphone and driver for extension cable up to 10mt. This preamplifier is provided with CTC device for electrical calibration, it can be directly plugged into the HD2010UC or using the extension cable..
- **HD2010PNE2W**: heated preamplifier with connection for UC52, ½” microphone and driver for extension cable. This preamplifier is provided with CTC device for electrical calibration, it can be plugged into the sound level meter or using the 5mt extension cable provided (10mt as an option).

Suitable for ¼ inch microphones

- **HD2010PNE4**: preamplifier for MC24E ¼” microphone. Equipped with CTC calibration device for electric calibration and driver for cable up to 100m. Requires the HDP079A02 microphone adapter.
- **HD2010PNE4H**: preamplifier for MC24EH ¼” microphone. Equipped with CTC calibration device for electric calibration and driver for cable up to 100m. Requires the HDP079A02 microphone adapter.

Accessories

The use of the following accessories does not significantly modify the HD2010UC/A technical specifications:

- HD SAV Windshield (with spectral correction Menu >> Calibration >> Shield >> SAV for type 1 version)
- HDP079A02 microphone adapter for ¼ microphones, for the use of MC24E microphone with HD2010PNE4 preamplifier and MC24EH microphone with HD2010PNE4H preamplifier.
- Extension cable between the preamplifier and the body of the sound level meter up to a maximum of 10m.
- Stabilized power supply SWD10.
- Portable thermal printer HD40.1.
- VTRAP tripod and HD2110/SA support for the preamplifier
- Outdoor protection HDWME: (with spectral correction Menu >> Calibration >> Shield >> WME for type 1 version)
- HD2010MC memory card reader.

METROLOGICAL CHARACTERISTICS

Frequency Weighting

- A, C, Z for RMS measurements
- C, Z for peak level measurements
- Filters with bandwidth corresponding to an octave from 31.5 Hz to 8 kHz.
- Filters with bandwidth equal to third octave (with “Third Octave” option) from 25 Hz to 12.5 kHz.

Z weighting is flat along the whole sound spectrum with the following features:

Attenuation [dB]	Frequency Range [Hz]
< 0.1	100 ÷ 20 k
< 1	31.5 ÷ 21 k
< 5	16 ÷ 22.5 k

Filters with bandwidth equal to an octave or third of octave are all class 1 filters according to IEC 61260.

Frequency Response

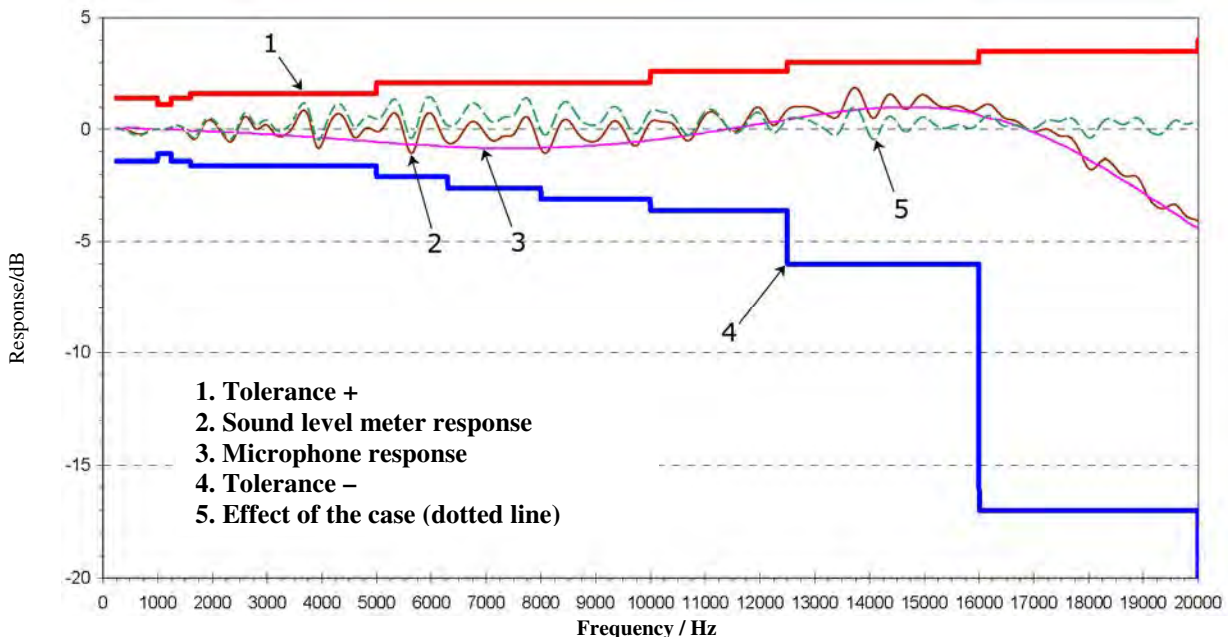

The selection of the UC52 microphones, on the basis of frequency response specifications, and the spectral corrections calculated by the sound level meter DSP allows obtaining a Class 1 response according to IEC61672. The HD2010UC/A is also available in the Class 2 version.

The frequency response of the microphone depends on the presence of devices like windshield HD SAV or all-weather protection unit HDWME. In order to make measurements with the maximum possible precision in different situations, the HD2010UC/A sound level meter can automatically apply spectral corrections needed to measure in random field conditions, or with the windshield or with the all-weather outdoor protection. Spectral correction for diffuse field measurement is enabled setting parameter Menu >> Calibration >> Mic.Resp.Correction >> RI while correction for HD SAV mounted, is enabled setting parameter Menu >> Calibration >> Shield >> SAV.

For more information on the applied corrections please refer to the UC52 microphone manual.

Outdoor microphone protection HDWME

The windshield and rain protection units mounted on HDWME outdoor protection, modify microphone frequency response: in order to apply the correction to sound level meter overall response, it's necessary to set the specific parameter Menu >> Calibration >> Shield >> WME. With this setting applied, HD2010UC/A sound level meter with HDWME protection, fully complies to type 1 specifications according to IEC 61672 standard; in such configuration, when used in vertical position, the sound level meter is able to measure accurately environmental noise from above (0° incidence) like for example the noise generated by aircraft over flights.

When parameter Menu >> Calibration >> Shield is set to WME and microphone acoustic response (menu Calibration >> Mic.Resp.Correction) is set to RI, it's applied a frequency spectral correction to obtain a flat frequency response in a diffuse field. Using this setting the HD2010UC/A sound level meter with HDWME outdoor protection mounted in vertical position, is suitable for measurements of environmental community noise due to noise sources on the ground (road traffic noise, railway noise...).

For more information on spectral correction applied to HD2010UC/A sound level meter when used with HDWME outdoor protection, please refer to UC52 microphone user manual.

Self-generated Noise

The intrinsic noise (measured replacing the microphone with the capacitive adapter) is shown in the following tables according to the different frequency weightings, either for **RMS** level or **peak level** measurements:

Input Gain [dB]	intrinsic noise [dB]				
	LpA	LpC	LpZ	LpkC	LpkZ
0	50	49	53	61	65
10	40	39	43	51	55
20	31	32	36	45	48
30	26	30	33	43	45
40	24	29	33	43	45

The intrinsic noise, by constant percentage bandwidth, both octave and third octave, is given in the following tables:

Input Gain [dB]	intrinsic noise by octave bands [dB]								
	32	63	125	250	500	1k	2k	4k	8k
40	24	31	19	18	18	19	15	16	17

Input Gain [dB]	intrinsic noise by third octave bands [dB]										
	25	31.5	40	50	63	80	100	125	160	200	250
40	20	19	15	9	9	8	8	8	8	8	9

Input Gain [dB]	intrinsic noise by third octave bands [dB]										
	315	400	500	630	800	1k	1.25k	1.6k	2k	2.5k	3.15k
40	9	13	13	12	12	17	11	10	10	11	11

Input Gain [dB]	intrinsic noise by third octave bands [dB]					
	4k	5k	6.3k	8k	10k	12.5k
40	11	11	12	12	13	13

Linearity range

The lower limit of the linearity range, by constant percentage bandwidth, can be taken by the intrinsic noise table and adding 7 dB. The upper limits correspond to 141 dB and 131 dB, respectively for input gain equal to 0 dB and 10 dB. The linearity range is almost independent of frequency in the 31.5 Hz ... 12.5 kHz interval, and it is shown in the following table according to the input gain:

Input Gain [dB]	Parameter	Lower Limit [dB]	Upper Limit [dB]
0	LpA	60	141
	LpC	60	
	LpZ	60	
	LpkC	68	144
	LpkZ	72	
10	LpA	50	131
	LpC	50	
	LpZ	50	
	LpkC	58	134
	LpkZ	62	
20	LpA	40	121
	LpC	40	
	LpZ	43	
	LpkC	52	124
	LpkZ	55	
30	LpA	33	111
	LpC	37	
	LpZ	40	
	LpkC	50	114
	LpkZ	52	
40	LpA	31	101
	LpC	36	
	LpZ	40	
	LpkC	50	104
	LpkZ	52	

The starting level for the linearity range detection matches the reference level (94 dB) at 1 kHz. With different frequencies, the starting level takes into account the attenuation of the frequency weighting being measured. In the secondary fields the starting level is subject to the same increment of the input gain.

Integration Time

It can be set from a minimum of 1s to a maximum of 99 hours.

Measurement Dynamics with Electromagnetic Fields

Minimum measurable level equal to 60dBA with carrier from 26 MHz to 1 GHz and amplitude equal to 10V/m modulated 80% at 1 kHz.

Reference Conditions

- The measuring range is that with input gain equal to 10 dB.
- The level corresponds to 94 dB.

- The acoustic calibration can be performed at a sound level included in the range 94dB ÷ 124dB.
- The reference direction of the acoustic signal is that of the preamplifier longitudinal axis.
- The reference acoustic field is the free field

Operating conditions

- Storage temperature: -25 ÷ 70°C.
- Operating temperature: -10 ÷ 50°C.
- Working relative humidity: 25 ÷ 90%RH, not condensing.
- Static pressure: 65 ÷ 108kPa.
- Protection degree: IP64.

In case of condensation growth, it must evaporate completely before using the sound level meter.

Drifts

- Temperature: ± 0.3 dB over the range -10 ÷ 50°C (with correction for microphone drift activated).
- Relative humidity: ± 0.3 dB over the range 25 ÷ 90%RH, not condensing.
- Static pressure: ± 0.3 dB over the range 65 ÷ 108kPa.

ELECTRICAL CHARACTERISTICS

Pre-heating time

Less than 10 seconds.

Power Supply

- Batteries: 4.8 V / 2.1 A NiMH rechargeable battery pack. The sound level meter has a battery charger function (see page 72 for the charging mode).
- Autonomy: >12 hours in RUN mode with good-quality batteries. Amounting to 8 hours when using the outdoor microphone unit HDWME fitted with heated preamplifier.
- External batteries: It is possible to connect external batteries to the sound level meter through the male connector for external power supply (Ø 5.5mm socket). The positive (pole) power supply must be connected to the central pin. The battery should supply 6÷12 V at about 200 mA/h.
- Mains: mains adapter with 5÷24 Vdc/500 mA continuous voltage.
- Switch-off: selectable auto-power-off.

When battery voltage falls below 3.9V, the sound level meter cannot perform any measurement. However it is possible to access and download the data in the memory. Under 3.5V, the instrument will automatically shut off. Logged data and configuration parameter are maintained even without power supply.

Input maximum levels

The maximum tolerable sound level with UC52 microphone is 146 dB.

The level of the electrical signal applicable to the microphone input, despite the replacement of the microphone capsule with the proper capacitive adapter, must not exceed 10Vrms.

LINE Output

- 3.5mm Ø mono jack
- Preamplifier output signal
- Non-weighted output protected against short-circuit
- Gain: ~ 3 mV/Pa and ~ 30 mV/Pa respectively for an input gain equal to 0 dB and 20 dB, not calibrated
- Linearity: 100dB with output maximum level equal to 2Vrms
- Series impedance: 1kΩ
- Typical Load: 100kΩ

DC Output

- 2.5mm Ø mono jack
- Short-circuit protected output
- A weighted output with FAST constant time updated 8 times/s
- Gain: 10 mV/dB Linearity: 80 dB
- Series impedance: 1kΩ
- Typical Load: 100kΩ

Serial interface

- Socket: 8-way M12
- Type: RS232C (EIA/TIA574) not insulated
- Baud rate: between 300 and 230400 baud
- Data bits: 8
- Parity: None
- Stop bits: 1
- Flow control: Hardware
- Cable length: max 15m

Extension Cable for the Microphone

The microphone preamplifier can be connected to the body through an extension cable up to 10m long (CPA). The sound level meter specifications are not significantly modified by the cable presence.

STATISTICAL ANALYSIS

Descriptors L_{AFp} or L_{eq} Short or L_{pk}

Sampling 1/8 s.

Classes from 0.5 dB.

Measurement range: 30dB ÷ 140dB.

4 percentile levels, programmable between L_1 to L_{99} .

Statistical graphs calculation and display .

Graph of the level distribution of probabilities

Graph of the percentile levels from L_1 to L_{99} .

SPECTRAL ANALYSIS

Sampling: 48 kHz

Reference Attenuation: 0dB
Reference Range: 50dB ÷ 130dB
Reference Level: 94dB
Octave bands from 31.5 Hz to 8kHz
Third Octave bands from 25Hz to 12.5kHz (option HD2010.O1)
Spectrum frequency weighting (only display): linear (Z) , C or A.
Ratio of filter central frequencies: base 2

Average spectra with sampling time equal to 0.5s, linearly integrated up to a maximum of 99 hours.

Multi-spectral analysis in 1 second intervals up to 1 hour (“Report” recording)

REVERBERATION TIME MEASUREMENT (OPTIONAL)

Reverberation time calculation by sound source interruption with guided wizard
Reverberation time calculation by applying (Schroeder’s inverse Integral) the impulse response technique and background contribution correction algorithm.
Frequency Range: octave from 125 Hz to 8 kHz and optional third of octave from 100 Hz to 10 kHz.
Spectrum Step: 32 spectra per second.
Measurement dynamic: 80dB.
Optimized interpolation of the decay profile, with correlation coefficient calculation using the Ordinary Least Squares method.
Simultaneous calculation of: EDT, T(10), T(20), T(30) estimations of the reverberation time T_{60} according to ISO 3382 standard.
Calculation of T_{60} directly on the decay profile over an interval selected by the user positioning the cursors.

VISUALIZATION

Graphic display

Backlit 128x64 pixels on a 56x38mm surface.

Mode:

- SLM (sound level meter) screen with 3 selectable parameters.
- Time profile of the A weighted sound pressure level with FAST time constant according to 1/8s intervals.
- Octave band spectra between 31.5 Hz and 8 kHz and third octave spectra between 25 Hz and 12.5 kHz.
- Level distribution of probabilities in 0.5dB, 1dB or 2dB classes.
- Graph of the percentile levels from L1 to L99.

Display mode for the reverberation time measurement

- Numeric screen providing the chosen band:
 - source maximum level
 - background noise level of the environment
 - EDT, T(10), T(20), T(30)

- Correlation coefficients of the 4 estimations of T_{60} .
- Sound level decay profile for the selected band.
- Graph of reverberation times, for the chosen estimation among EDT, T(10), T(20) or T(30), for all octave bands from 125 Hz to 8 kHz.
- Graph of reverberation times, for the chosen estimation among EDT, T(10), T(20) or T(30), for all third octave bands from 100 Hz to 10 kHz (“Third Octaves” option)

STORAGE OF MEASUREMENTS

The basic version is fitted with a permanent 4 MB memory; it allows recording of:

- Continuous recording mode: Over 23 hours of recording (3 parameters twice a second plus 1 parameter 8 times a second)
- Auto-Store mode: Over 48 hours of recording of 3 parameters with spectra for octave and third octave band (with the “Third Octave” option) at 5-second intervals.
- Report recording mode: more than 5 days recording based on intervals of 1 minute including 5 user definable descriptors, average spectrum in third octave bands and statistical analysis.

Optionally, the memory is expandable to 8 MB.

Security of memorized data

Independent of battery charge.

PROGRAMS

Calibrations and Diagnostic Programs

- Acoustic calibration at 1kHz using a sound level calibrator included in the range: 94dB ÷ 124dB
- Electrical calibration with built-in generator.
- “Diagnostic check” program”.

Reverberation time measurement program

This program allows reverberation time measurement, according to a wizard, using both the sound source interruption technique and the integrated impulse response.

Interface and processing programs using a PC

- Noise Studio (basic version) for download and graphic display of stored data, as well as for instrument configuration
Noise Studio includes a number of optional modules for analysis and post-processing of noise measurements captured using the Delta Ohm sound level meters. The functions in these modules are specifically developed for given applications (such as noise analysis in the workplace or railway traffic noise analysis) and **can be enabled on a licence protected hardware key (CH20)**.
- “**Workers Protection**” module – cod.NS1 module is used to get and process the sound measurements performed in workplaces. Data are transferred from the sound level meter memory to the PC using the Noise Studio program. Here, they can be processed in compliance with the Italian and European Community rules concerning noise in workplaces.
- “**Acoustic Pollution**” module – cod.NS2A – module for acoustic climate analysis on a daily, weekly and annual basis including road, railway and airport noise. The software performs statistical and spectral analysis and automatically identifies noisy events. The analyses are performed in compliance with the national (D.L.194/2005 and D.M. 16/03/1998) and EU legislation regarding the acoustic pollution and the mapping of the territory. (NS2A analysis request “advanced data logger” to be installed in the sound level meter).

- “**Acoustic Insulation**” module – cod.**NS3** – for evaluation of airborne sound insulation according to national and international standards. Calculation of reverberation time in rooms and calculation of partitions and façades insulation, and tapping noise according to ISO140 standards. Calculation of sound insulation indexes according to ISO 717-1:1996 and ISO 717-2:1996. This program requests the “reverberation time” option installed in the sound level meter.
- “**Monitor**” module - cod.**NS4** - for the acoustic monitoring and remote control via PC or via modem. Programmed acquisition, event identification and synchronized audio recording.

For a detailed description of software features actually available please contact your authorized local distributor.

Firmware

To be upgraded via the serial port with Noise Studio software.

OTHER CHARACTERISTICS

Printing

- Direct printing of logged parameters (printing of a single event)
- Continuous Printing (Monitor).

Case

- Dimensions (Length x Width x Height): 445x100x50mm equipped with preamplifier,
- Weight: 740g (batteries included)
- Materials: ABS, rubber

Time

- Date and time: clock and date updated in real time
- maximum deviation is less than 1min/month

REFERENCE STANDARDS

- IEC 60651:2001, Class 1 or 2
- IEC 60804:2000 , Class 1 or 2
- IEC 61672-1:2002 and IEC 61672-1 ed.2.0 of 2013, Class 1 or 2 Group X
- IEC 61260:1995 by octave and one-third octave bands, Class 1
- ANSI S1.4-1983, Type 1 or 2
- ANSI S1.11-1986 by octave and one-third octave bands, Order 3, Class 1-D, Wide Range.

ITALIAN LAWS

- Noise in working environment: D.L. 81/2008, UNI 9432/2011, ISO9612/11 and Directive 2008/46/CE.
- Acoustical climate assessment and monitoring with sound events capture
- Noise of entertainment dancing spaces: D.P.C.M. 215 del 16/04/99
- Noise emission from machines D.L 262 del 04/09/2002, Directive 2000/14/CE and 2005/88/CE
- Measurement of building's passive acoustic requirements and acoustic classification of building according to: EN ISO 3382 and UNI 11367:2010 ("Reverberation Time" option required).

ORDER CODES

HD2010UC/A.Kit1: Kit HD2010UC/A class 1 integrating sound level meter and analyser with octave bands spectrum analysis, 4 MB memory and advanced data logging functions, complete statistical analysis, capture and analysis of sound events.

The Kit includes: type 1 HD2010UC/A sound level meter, UC52/1 pre polarized condenser microphone ½”, HD2010PNE2 preamplifier (HD2010PNE2W with opt. HD2010.OE), HDSAV windshield, HD2110USB cable (alternatively, on request, HD2110RS serial cable for RS232 connection), SWD10 power supply, Noise Studio (basic module) PC interface software, IEC 61672 and IEC 61260 manufacturer conformity declaration, carrying case, instruction manual.

HD2010UC/A.Kit2: Kit HD2010UC/A class 2 integrating sound level meter and analyser with octave bands spectrum analysis, 4 MB memory and advanced data logging functions, complete statistical analysis, capture and analysis of sound events.

The Kit includes: type 2 HD2010UC/A sound level meter, UC52 pre polarized condenser microphone ½”, HD2010PNE2 preamplifier (HD2010PNE2W with opt. HD2010.OE), HDSAV windshield, HD2110USB cable (alternatively, on request, HD2110RS serial cable for RS232 connection), SWD10 power supply, Noise Studio (basic module) PC interface software, IEC 61672 and IEC 61260 manufacturer conformity declaration, carrying case, instruction manual.

Options, accessories and software

HD2010.O0 “Memory module”: memory extension of 4MB.

HD2010.O1 “Third Octaves”: spectral analysis in third octave bands from 25Hz to 12,5kHz class 1 according to IEC 61260. Includes Calibration Certification according to IEC61260.

HD2010.O4: “Reverberation time” option reverberation time measurement with the sound source interruption technique and the impulsive source method.

HD2010.O1/4 “Microphone chain for high levels measurements” (up to 160dB): replaces HD2010PNE2 preamplifier and UC52/1 microphone with HD2010PNE4 preamplifier, complete with HDP079A02 microphone adapter, and MC24E ¼” microphone with 2 mV/Pa sensitivity. **Available only for the kit HD2010UC/A.Kit1.**

HD2010.O1/4H “Microphone chain for high levels measurements” (up to 180dB): replaces HD2010PNE2 preamplifier and UC52/1 microphone with HD2010PNE4H preamplifier, complete with HDP079A02 microphone adapter, and MC24EH ¼” microphone with 0.25 mV/Pa sensitivity. **Available only for the kit HD2010UC/A.Kit1.**

HD2010.OE “Microphone chain for outdoor measurements”: replaces the standard HD2010PNE2 preamplifier with the heated version HD2010PNE2W, equipped with CTC device for electrical calibration and 5m integrated extension cable (10m on request); includes the outdoor unit HDWME with windshield, rain shield and bird spikes. This option is available only in combination with the standard microphone.

HD2020: class 1, according to IEC60942:2003, acoustic calibrator with LCD display. Suitable for ½” and, with HD2020AD4 adapter not included, ¼” standard microphones. Calibration frequency 1000 Hz, levels 94 dB and 114 dB. ACCREDIA calibration certificate is included.

HD2022: class 2, according to IEC60942:2003, acoustic calibrator. Suitable for ½” and, with HD2020AD4 adapter not included, ¼” standard microphones. Calibration frequency 1000 Hz, level 114 dB. ACCREDIA calibration certificate is included.

HD2020AD4: ½”- ¼” adapter for ¼” microphones. It can be used with HD2020 and HD2022 calibrators.

CPA/5: 5m extension cable for HD2010PNE2 preamplifier.

CPA/10: 10m extension cable for HD2010PNE2 preamplifier.

SWD10: stabilized power supply with $V_{in}=100-240V_{ac}$ / $V_{out}=12V_{dc}/1000mA$.

VTRAP: tripod, max. height: 1550 mm

HD2110/SA: support to fix the preamplifier to the tripod.

HD2110RS: RS232 null-modem cable with DB9 standard connector.

HD2110USB: USB cable with type A connector.

HD40.1: the kit includes: 24-column portable thermal printer, serial interface, 57mm paper width, four NiMH 1.2V rechargeable batteries, SWD10 power supply, instruction manual, 5 thermal paper rolls.

HD2010MC: data logging and download module for Secure Digital SD memory cards. Included 2GB SD card.

Post processing software modules

- **CH20:** hardware protection dongle for PC with Windows operating systems. Plugged in USB ports it enables the use of analysis modules.
- **NS1: “Workers Protection”** module, used to get and process the sound measurements performed in workplaces according to ISO 9612:2011. Data are transferred from the sound level meter memory to the PC using the Noise Studio program. Here, they can be processed in compliance with the Italian and European Community rules concerning noise in workplaces. Exposition calculations take into account uncertainty and efficacy of PPE. Impulsivity index is taken into account.
- **NS2A: “Acoustic Pollution”** module for acoustic climate analysis on a daily, weekly and annual basis including road, railway and airport noise. The software performs statistical and spectral analysis and automatically identifies noisy events. The analyses are performed in compliance with the national (D.L.194/2005 and D.M. 16/03/1998) and EU legislation regarding the acoustic pollution and the mapping of the territory. (NS2A analysis request “advanced data logger” to be installed in the sound level meter).
- **NS3: “Acoustic Insulation”** module for evaluation of airborne sound insulation according to national and international standards. Calculation of reverberation time in rooms and calculation of partitions and façades insulation, and tapping noise according to ISO140 standards. Calculation of sound insulation indexes according to ISO 717-1:1996 and ISO 717-2:1996. This program requests the “reverberation time” option installed in the sound level meter.
- **NS4: “Monitor”** module for the acoustic monitoring and remote control via PC or via modem. Programmed acquisition, event identification and synchronized audio recording.
- **NS5: “Environmental Noise”** module for analysis of acoustic pollution and environmental noise sources. The software performs statistical and spectral analyses, automatically identifies noisy events and the pulse and tonal components of the noise sources. The analyses are performed in compliance with the national (D.L. 194/2005 and D.M. 16/03/1998) and EU legislation regarding the acoustic pollution.

Spare parts and accessories

UC52/1: pre-polarized microphone for free field with class 1 frequency response.

UC52: pre-polarized microphone for free field with class 2 frequency response.

MC24E: ¼” pre-polarized microphone for free field measurements up to 160dB. It can be combined with HD2110PEL4 preamplifier by using the HDP079A02 adapter.

MC24EH: ¼” pre-polarized microphone for free field measurements up to 180dB. It can be combined with HD2110PEL4H preamplifier by using the HDP079A02 adapter.

HDWME: outdoor protection with windscreen, rain shield and birds spike. Included: windscreen HDSAV3, anti-birds spike HDWME1, rain shield HDWME2, stainless steel support HDWME3

HDWME1: anti-birds spike for HDWME outdoor protection.

HDWME2: Rain shield for HDWME outdoor protection.

HDSAV3: Windscreen for HDWME outdoor protection.

HDSAV: Windscreen for ½” microphone.

BAT4V8NIMH: Spare battery pack for the sound level meter.

BAT-40: Spare battery pack for HD40.1 printer

RCT: 4 rolls of thermal paper, 57 mm width and 32 mm diameter

HD2010PNE2: microphone preamplifier with standard connection for prepolarized ½” microphones. Provided with CTC device for electrical calibration.

HD2010PNE2W: heated microphone preamplifier (for the HDWME unit) with standard connection for prepolarized ½” microphones. Provided with CTC device for electrical calibration and with a driver for extension cable up to 5m (other lengths on demand).

HD2010PNE4: preamplifier for MC24E ¼” microphone. Equipped with CTC calibration device for electric calibration and driver for cable up to 100m. Requires the HDP079A02 microphone adapter.

HD2010PNE4H: preamplifier for MC24EH ¼” microphone. Equipped with CTC calibration device for electric calibration and driver for cable up to 100m. Requires the HDP079A02 microphone adapter.

WHAT SHALL I DO IF ...

This chapter deals with the step by step description on how to carry out the most recurrent measurements in the acoustic field with the HD2010UC/A sound level meter. If necessary, see the description of the key functions from page 111 and the different display modes from page 15 onwards.

MEASUREMENT PROCEDURE

The HD2010UC/A sound level meter can acquire 3 parameters simultaneously (twice/second), as well as the A weighted sound level with FAST constant time 8 times/second (PROFILE Mode). The available parameters are those listed in the tables of appendix A1, on page 118.

Sound Level Meter (SLM) – See also the description on page 17.

Use the MODE key to select the SLM display, where 3 measuring parameters are shown in numeric format. Press ENTER repeatedly to set the integration time (Tint), the measuring range and the parameters to be displayed as described in the paragraph “*Selecting Parameters*” of chapter “*SLM (sound level meter) Mode*” on page 17.

Alternatively, measuring parameters can be set from menu, as described in the chapter “DESCRIPTION OF THE MENU FUNCTIONS” on page 37. Once parameters have been set, start the measurements by pressing the START/STOP/RESET key.

When the Tint time is over, the HOLD indication will appear and display update will stop. Now you can print or store the values. Meanwhile, the instrument goes on measuring: to continue display updating, just press the HOLD key. When the continuous recording is activated and the Tint time goes over, the acquisition is stopped automatically.

If you press HOLD during the measuring phase, the display update will be temporarily interrupted. When HOLD is pressed again, the updating will continue. Even if the display is not updated, the instrument will go on measuring.

Pressing PAUSE, acquisition and calculation of the integrated parameters will be temporarily interrupted. When in PAUSE, the calculation of integrated parameters, such as, for example, Leq and the maximum levels, is suspended; in this phase the contribution of the last seconds of acquisition can be deleted using the “Back-Erase” function and the LEFT and RIGHT keys, as described in the paragraph: “*Back-Erase Function*” on page 18. While in PAUSE, all integrated parameters can be cleared pressing START/STOP/RESET. Press PAUSE once more to start measuring again.

Press PRINT at any time to print the on-screen data. To activate the continuous printing (*Monitor*), press and hold down PRINT for at least 2 seconds. A flashing **M** overlapping the status indicator, shows that the Monitor function is active. The Monitor function remains active even jumping to other measuring views and can be disabled pressing PRINT again or START/STOP/RESET to stop measurement.

Profile Mode (Time history) - See also the description on page 19.

With the MODE key you can open the PROFILE screen, in which the time profile of the A weighted sound pressure level with FAST time constant is shown graphically. The sampling interval is equal to 1/8s.

Once parameters have been set with the START/STOP/RESET key, the execution is started. Once the Tint time (defined in the SLM page) is over, HOLD will be displayed: display update will stop. Meanwhile, the instrument goes on measuring: to continue display updating, just press the HOLD key. When the continuous recording is activated and the Tint time goes over, the acquisition is stopped automatically.

If you press HOLD during the measuring phase, the display update will be temporarily interrupted. When HOLD is pressed again, the updating will continue. Even if the display is not updated, the instrument will go on measuring.

If you press PAUSE, the acquisition will be temporarily suspended. While in pause, press START/STOP/RESET to clear the graph. Press PAUSE once more to start measuring again.

If you press CURSOR at any moment, a cursor will be activated. If you press CURSOR once more, a second cursor will activate, while, if you press it for the third time, both cursors will be activated in “tracking”. Use the LEFT and RIGHT arrows of the keypad to shift the selected cursors into the desired position to indicate the measured level and the corresponding acquisition time. Press CURSOR again to disable cursors.

Press PRINT at any time to print the on-screen data. To activate the continuous printing (Monitor), press and hold down PRINT for at least 2 seconds. The flashing letter M, over the status indicator, indicates that the Monitor function has been activated. The Monitor function remains active even when jumping to other measuring views and can be disabled pressing PRINT again or START/STOP/RESET to stop measurement.

Spectrum (by octave and optional third octave bands) - See also the description on page 21.

Press MODE to view the SPECTRUM screen by octave or third octave bands (with the “Third Octave” option), where the frequency spectrum by constant percentage bandwidths is displayed. Use ENTER to set the integration time or the frequency weighting of the wideband auxiliary channel, as described in the paragraph “Spectrum Mode” on page 21. Alternatively, measuring parameters can be set from menu, as described in “DESCRIPTION OF THE MENU FUNCTIONS” a pag. 37. Once parameters have been set via the START/STOP/RESET key, the execution is started.

Once the Tint time (in common with the SLM screen) is over, HOLD will appear and the spectrum updating will be temporarily suspended. Meanwhile, the instrument goes on measuring: to continue display updating, just press the HOLD key. If you press HOLD during the measuring phase, the display update will be temporarily interrupted. When HOLD is pressed again, the updating will continue. Even if the display is not updated, the instrument will go on measuring.

Also data acquisition can be temporarily suspended with the key PAUSE. To clear the graph, when in pause, press START/STOP/RESET. Press PAUSE once more to start measuring again.

Press PRINT at any time to print the on-screen data. To activate the continuous printing (Monitor), press and hold down PRINT for at least 2 seconds. A flashing M over the status indicator, shows that the Monitor function is active. The Monitor function remains active even when jumping to other measuring views and can be disabled pressing PRINT again or START/STOP/RESET to stop measurement.

Press REC for 2 seconds at any time to store the displayed data. As soon as data are saved on memory, a screen will allow you to enter the recording title. Activating the single data recording, while in STOP mode, is first asked to choose between automatic (Auto-Store) or manual recording).

To activate a cursor at any moment, press CURSOR. If you press it again, a second cursor will be activated; if pressed for the third time, both cursors will be activated in “tracking”.

Use the LEFT and RIGHT arrows on the keypad to shift the selected cursors to the desired position to detect the measured level and the nominal frequency of the selected band. Press CURSOR again to disable cursors. Please see the paragraph “USING THE CURSORS” on page 20.

STORAGE OF MEASUREMENTS

The HD2010UC/A offers three different storage modes:

1. The **Continuous Recording** (press REC and START keys simultaneously) implies the storage of the SLM screen-page (2 samples a second) together with the time profile of the A weighted

sound pressure level with FAST constant time (8 samples a second). It is also possible to record the Report and Event groups data, each composed of: 5 programmable levels, average spectra for octave and third octave band, and statistical analysis. The Event group data are recorded at the end of each event and the Report group data are recorded at programmable intervals from 1s to 1 hour. The REC symbol as status indicator shows when the sound level meter is recording. If you press STOP, recording will be stopped and you will be asked to confirm the title. While recording, you can press PAUSE to suspend recording.

2. The **Auto-Store** mode can be activated either through the parameter MENU >> Recording >> Auto-Store or by pressing REC and holding it down for at least 2 seconds with the sound level meter in STOP mode. Then select the AUTO option when you are requested to choose the recording option.

The flashing REC symbol, overlapping the status indicator, shows that the sound level meter is recording. Press START to start recording and STOP to stop it. A flashing REC over the RUN status indicator, shows when the sound level meter is recording. Press REC with the instrument in STOP to disable the Auto-Store. The Auto-Store recording mode allows to record automatically data displayed on SLM, OCTAVE and T.OCTAVE (with option) screens at the end of the set integration interval (MENU >> Instrument >> Measurements >> Integration Interval); the measurement will be automatically interrupted immediately after recording.

3. **Single screen** storage is obtained by pressing REC for at least 2 seconds when the instrument is in RUN or STOP mode. If the instrument is in STOP mode you will be prompted to choose between automatic and manual storage; the current screen will be stored if choosing the latter.

The *Continuous Recording* allows recording the time profile of instantaneous and integrated levels. This means that you can record, for example, the sound pressure level with FAST time constant 8 times a second and, at the same time, the sound pressure levels with SLOW time constant, the peak level, and the Leq over 0.5s twice a second. At the end of recording, you can manually store the average spectrum calculated while recording.

MEASUREMENT OF NOISE DOSE

The **Dose** represents the percentage of a maximum value of noise exposure throughout a day:

$$D(Q) = \frac{100}{T_c} \cdot \int_0^T 10^{\frac{L-L_c}{q}} dt$$

where:

$D(Q)$ = exposure percentage for an Exchange Rate equal to Q .

T_c = daily exposure time (usually 8 hours).

T = measurement time.

L = sound pressure level when it is higher than the Threshold Level, and $-\infty$ otherwise.

L_c = Criterion Level for a daily exposure corresponding to 100% of the dose.

Q = Exchange Rate.

q = parameter independent of the exchange rate and equal to:

- 10 for $Q = 3$ dB
- $5/\log 2$ for $Q = 5$ dB
- $4/\log 2$ for $Q = 4$ dB
- $4/\log 2$ per $Q = 4$ dB

The sound level meter calculates the following parameters: *DOSE (A)*, the percentage of the daily effective dose, and *DOSE,d (A)*, the estimated daily DOSE according to the programmed parameters.

The DOSE calculation is characterized by three parameters:

1. **DOSE Criterion** is the SPL constant value, which continuous exposure for 8 hours determines a 100% DOSE.
2. **DOSE Threshold** that represents the SPL level under which the DOSE is not increased.
3. **Exchange rate** is the variation of the SPL value that determines a double or half duration of exposure with the same DOSE Criterion. Provided values are 3, 4 or 5dB.

The three configuration parameters are contained in the submenu Measurement (MENU >> Instrument >> Measurement): once they have been set, select the submenu Sound Level Meter (MENU >> Sound Level Meter) and choose, according to the type of measurements to be made, between the parameters DOSE (A) or DOSE,d (A).

The integration time can be entered directly in the SLM measuring window. Now the instrument is ready to carry out the measurement: press START. After Tint time has elapsed, the instrument turns into the HOLD status and displays the DOSE calculated over the set time.

STATISTICAL ANALYSIS

Up to 4 percentile levels are selectable in the SLM display mode (MENU >> Instrument >> Measurement >> Percentile Lev. 1-4), programmable between L_1 and L_{99} . The statistical analyzer samples the sound pressure A weighted level with FAST time constant, 8 times a second; the levels are accumulated in 0.5dB classes. The percentile levels are calculated interpolating the cumulative distribution.

It's possible to choose which descriptor the statistical analysis is performed on: equivalent level, sound pressure level with FAST time constant, and peak level. The complete statistical analysis is available with the distribution of probabilities graph and the L_1 to L_{99} percentile level graph.

DATA PRINTING

The displayed values can be printed at any time in all display and acquisition modes.

Besides the *Monitor* function can be activated via the serial line when you press PRINT and hold it down for 2 seconds. This function allows to continuously send displayed data in real time to the serial interface. The transferred data are those of the active display mode at the time PRINT was pressed. Data are continuously transferred until PRINT is pressed again, or until the acquisition is stopped. The Monitor function can be activated even in the STOP acquisition mode; it will start as soon as the instrument turns into RUN mode. The Monitor works independently from any recording of data on memory.

Using the Monitor function it is possible, with the help of a PC, to make measurements limited only by the PC storage capacity.

TROUBLESHOOTING

The HD2010UC/A sound level meter is provided with a diagnostic program (DIAGNOSTIC CHECK) that automatically checks the instrument main parameters. This program can be run at any time to check the instrument operating conditions (see description on page 55).

One of the parameters being analyzed is the sensitivity of the amplification channel that includes, through a charge partition circuit (CTC), the microphone capacity. Measurement is made at 1kHz.

DIAGNOSTIC CHECK

1. *The DIAGNOSTIC CHECK program fails*

Replace batteries and try again after waiting for the end of the stabilization time and, if the problem remains, contact service.

CALIBRATION

1. *The ELECTRIC CALIBRATION program fails*

Ensure that the instrument is not subject to high noise and/or vibrations.

Try again after having waited for the end of the stabilization time and, if the problem remains, run the ACOUSTIC CALIBRATION program.

2. *The ACOUSTIC CALIBRATION program fails*

Ensure that the instrument is not subject to high noise and/or vibrations and that acoustic calibrator and sound level meter are steadily aligned and that the microphone is properly plugged in the calibrator cavity. Check that the seal rubber ring is present and undamaged.

Try again after having waited for the end of the stabilization time and, if the problem remains, load the factory calibration following these steps:

- Ensure that acquisition is on STOP.
- Disconnect the batteries while the instrument is switched on: this operation ensures that all the instrument internal circuits are discharged.
- Press and **hold ENTER down** and then connect the batteries. The instrument will switch on and will display a warning relevant to the load of factory calibration. Release ENTER and press the key on the right near the CONTINUE key.
- After having waited for the stabilization time, run the program ACOUSTIC CALIBRATION.

Should the program fail, contact the service department.

RESTORING FACTORY CALIBRATION

The default configuration of the instrument parameters (factory setup) can be recalled at any time by means of a combination of keys. **This operation does not clear the content of data memory.**

While the instrument is off, press and hold down ENTER and power on the sound level meter. All the menu items are simultaneously brought back to the default value.

RESTORING FACTORY CALIBRATION

The Factory Calibration can be recalled at any time by means of a combination of keys. **This operation does not clear the content of data memory.**

While the instrument is off, disconnect the batteries and wait at least 5 minutes for the sound level meter internal circuits to discharge.

Press and hold down the ENTER key while reconnecting the batteries: the sound level meter will automatically turn on. Confirm the load of factory calibration.

The sound level meter calibration parameters are restored to the last factory calibration; all menu items are simultaneously brought back to the factory parameters (default).

MISCELLANEOUS PROBLEMS

1. *The instrument does not turn on after battery replacement.*
 - Disconnect the batteries and wait at least 5 minutes before reconnecting them. The instrument should turn on automatically when the batteries are connected.
2. *The detected sound levels seem incorrect.*
 - Ensure that no condensation is present on the capsule or preamplifier. Avoid turning on the instrument in conditions of possible condensation growth. Use the outdoor microphone unit HDWME to perform measurements in conditions of high humidity or when it is raining.
 - Check that the warm-up time, indicated by a blinking letter “W” over the upper left status indicator, has elapsed.
 - Check measurement accuracy using the acoustic calibrator.
 - Load factory calibration.
 - Check that the microphone protection grid is screwed down on the capsule securely.
3. *Upon turning the sound level meter on, it turns off automatically right after the introduction screen.*
 - The batteries are flat.
4. *The sound level meter does not communicate with the PC.*
 - Check that the sound level meter and PC communication speed is the same (MENU >> Instrument >> Input/Output >> Baud Rate).
 - Check that the connection cable is plugged correctly in the sound level meter and is connected to a PC serial port or USB with the item MENU >> Instrument >> Input/Output >> Serial device set up respectively on RS232 or USB respectively.
 - If you use a USB interface, check that the driver is correctly installed.
 - If you use a Noise Studio program, disable the AutoDetect function (Menu Option >> Port Settings) and set the connection directly to the COM port to which the instrument is connected with the same baud rate of the sound level meter (Menu >> Instrument >> Input/Output >> Baud Rate).
5. *It is not possible to activate continuous recording. By pressing REC and RUN, the instrument starts measurements without recording.*
 - The instrument does not have available memory for additional data. Download the data and/or erase the memory.

KEYBOARD DESCRIPTION

HOLD

HOLD key

The HOLD key can be used to temporarily suspend the display update while the instrument continues making the requested measurements. A “H” in the left corner at the top shows that the display is in this phase. Press the key again to go back to standard measurement. While the instrument is in HOLD mode, you can jump from a screen-page to the other, activate the cursors on the graphic pages, print and store data. Recording and the Monitor function are not affected by the HOLD status.



ON/OFF key

To switch on or off the instrument, press the ON/OFF key **for at least one second**. Upon the power on, the instrument shows for a few seconds the manufacturer’s logo and the firmware version. Then it switches to the SLM working mode (Sound Level Meter) and displays 5 instantaneous or integrated measurement parameters in numeric form.

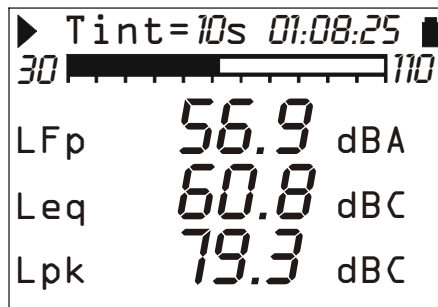

Before switching off the instrument, press STOP to end the ongoing measurement. If you do not do it, a message will request you to stop the measurement in progress: “WARNING! Stop the measurement to continue”.

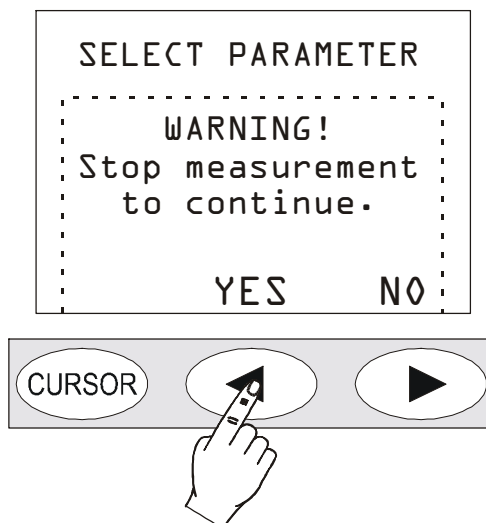

Press YES and then ON/OFF to switch off the instrument.

“Auto Power Off” Function

The instrument is provided with the Auto-PowerOff function that switches automatically off the instrument after 5 minutes when it is in STOP and no key is pressed in this time interval. Before switching off, the instrument will make a series of beep: in this phase you can press a key to prevent the instrument from switching off.

The function can be disabled from the MENU via the "Auto-Power-Off" item (MENU >> Instrument >> System >> Auto-Power-Off = OFF). In this case, the battery symbol flashes to remind the user that the instrument will not switch off automatically, but only if the <ON/OFF> key is pressed. The *Auto-Power-Off* function is temporarily disabled when an external power supply is used or when the instrument is recording or running a program.



MENU key

The HD2010UC/A sound level meter requires, according to its use, many parameters to be set. If you press MENU, you can access all instrument parameters, for the following functions:

- Instrument
- Sound Level Meter (SLM)
- Spectrum Analyzer
- statistical analyzer
- Trigger
- Recording
- Calibration
- Sequencer

Inside the menus you can:

- Move from one item to the other within the same menu by means of the UP and DOWN arrows,
- Press ENTER to choose an item to be modified,
- Use the UP and DOWN keys to modify the selected parameter,
- Press ENTER to confirm a change, or press MENU to cancel it,
- Press MENU to exit the menu or the submenu.

Some of the parameters available via menu can also be set directly during the measurement phase (like, for example, the integration interval, the measuring range, etc.)

When you access the menus, the available memory will be displayed, as well as battery level, date and time.

See a detailed description of the menu items on page 37 and following pages



PRINT key

Press PRINT to send the screen page to the RS232 serial interface, in a printable format.

Data can be sent to a serial printer (like for example HD40.1 – see page 86), directly connected to the sound level meter. In this last case, set the parameter MENU >> Instrument >> Input/Output >> Serial Device to: PRINTER, to get a printing format compatible with a portable 24 column printer.

Data downloading to a PC can be managed via a communication program, such as, i.e., Windows HyperTerminal.

If the key is pressed and soon released, the single screen page is sent to the serial line; the letter “P” will be displayed. If the key is hold down, the continuous printing (Monitor) will be started and the letter “M” will be displayed: to stop it, press PRINT again or press START/STOP/RESET to stop logging.

If the sound level meter is interfaced via RS232 with programs like HyperTerminal, it's possible to read measured values directly on the PC display. The same functions available for paper print can be enabled for video display.



PROG key

The PROG key is used to access the menu of the instrument programs. Use the UP and DOWN arrows to select the program; press ENTER to activate the selected program. These are the available programs:

- *Memory Navigator*: allows accessing stored data and viewing them on the instrument display. It works both with single session data and with multiple ones. (See details on page 44).
- *Electric Calibration*: single-frequency (1kHz) with electrical signal coming from the built-in sinusoidal reference generator. (See details on page 44).
- *Electric Calibration*: single-frequency (1kHz) with electrical signal coming from the built-in sinusoidal reference generator. (See details on page 50).
- *Acoustic Calibration*: is used for the sound level meter tuning at 1kHz with an acoustic calibrator. (See details on page 52).
- *Diagnostic Check*: this program checks several instrument parameters: supply voltages, microphone polarization and sensitivity, type of preamplifier (see details on page 55).
- *Reverberation*: it is a program to calculate reverberation times (option 4) according either to the technique of interruption of the sound source or to the impulsive source technique. (See details on page 56).
- *Data download on (SD) MC*: this program allows to copy measurements store in the sound level meter internal flash memory to an external memory card (ref. chapter on MC reader on page 89).

The selected program is performed upon pressing the ENTER key; some programs can be aborted at any time by pressing RIGHT on the keypad. When you access the programs, the available memory will be displayed, as well as battery level, date and time.



PAUSE/CONTINUE key

The PAUSE key interrupts the calculation of integrated measurements (Leq, SEL, maximum or minimum levels, spectra, etc.), as well as recording. The instantaneous levels are still measured and displayed in the SLM screen. Press PAUSE/CONTINUE to start measuring again. The integrated parameters are cleared if you press RUN/STOP/RESET while in PAUSE (during a measurement session). The last seconds of integration can be excluded, from the calculation of integrated parameters shown on the SLM screen (for example, to eliminate the effect of an undesired noise), using the LEFT and RIGHT keys while in PAUSE. The maximum erasing interval is programmable from 5 seconds to 60 seconds via MENU >> Instrument >> Measurement.

If you press the RUN/STOP/RESET key while in pause during the replay of a recording, the next stored data will be displayed. If you press the RUN/STOP/RESET key and hold it down, the replay will be performed in fast forward mode.



REC key

If REC is pressed and hold down for at least 2 seconds, the displayed data are stored as a single report. You can also activate the automatic recording of the parameters displayed on the SLM, OCTAVE and, optionally, T.OCTAVE pages (see THE RECORD FUNCTION on page 32).

The REC key, combined with START/STOP/RESET, activates the data logging. **Starting from the STOP condition**, if you press REC and hold it down, then press START/STOP/RESET, the data logging of measured values is started. To stop logging, press START/STOP/RESET: registration number, date and time will be displayed. Press ENTER to confirm.



RUN/STOP/RESET key

If you press RUN, while in stop, all the initial values of the integrated measurements like Leq, SEL, MAX/MIN levels will be first cleared (RESET) and then measurement starts. Pressing the key again (STOP), the measurements will be stopped. **If pressed while in pause, all integrated parameters will be cleared.**

During the replay of stored data, if you press this key while in pause, the next data will be displayed; if you press it and hold it down, the replay will be executed in fast forward mode.



UP key

The UP key selects a previous line in the menus or increases the selected parameter. Decreases the graphs scale limits of the time profile and of the frequency spectra moving data upwards.



MODE key

The MODE key selects the different display modes of the instrument from *SLM* to *PROFILE*, to *OCTAVE* or *THIRD OCTAVE* spectrum (*with the “Third Octave” option*), *sound level distribution of probabilities and percentile levels graph*.

It is possible to disable the display of the screen related to the spectrum analyzer and the statistical analyzer using the appropriate parameters in the relevant menus.

All operating modes are active at the same time, even though not displayed: using the MODE key, you can select the display mode without affecting measurement.



LEFT key

The LEFT key selects the previous character in the active line of the menu. It jumps to a previous parameter during the selection of a measurement variable that needs the definition of more than one parameter. It reduces (ZOOM-) the vertical scale of frequency spectra graph.



ENTER key

The ENTER key confirms the selected parameter. When setting parameters from the menu, to quit setting without saving a parameter, just press any key except **ENTER and the four arrows**, or press MENU. Factory setup is loaded into the sound level meter by turning it on while holding the **ENTER** key



RIGHT key

The RIGHT key selects the next character in the active line of the menu. It jumps to the next parameter during the selection of a measuring variable that needs the definition of more than one parameter. It expands (ZOOM+) the vertical scale of frequency spectra graph.



DOWN key

The DOWN key selects the next line in the menus or decreases the selected parameter. Increases the vertical scale limits of frequency spectra graphs moving the data downwards.



CURSOR (Keypad)

It activates the cursors in a graph. Press it repeatedly to activate in sequence: the first cursor L1, the second one L2 or both of them in “tracking” (ΔL). To disable the cursors, press the key again.

Use the LEFT and RIGHT key of the keypad to move the flashing selected cursor over the graph.

Relevant values are shown at the top of the display.

When the instrument works as spectrum analyzer, the display shows, starting from the left, the selected measuring parameter together with the sound level and the nominal frequency corresponding to the band selected by the cursor. The cursor can also select the wide band level on the right side of the display.



LEFT (Keypad)

The LEFT key moves leftwards the cursor or the two active cursors (flashing).

In the decay profile screen (*reverberation time measurement*) it's used to move the time axis downwards when cursors are not active.



RIGHT (Keypad)

The RIGHT key moves rightwards the cursor or the two active cursors (flashing).

It is used in the FFT screen to move the frequency axis upward when the cursors are not active.

It is used in the decay profile screen (*reverberation time measurement*) it is used to move the frequency axis upward when the cursors are not active

ANNEX

A1. HD2010UC/A MEASURING PARAMETERS

The tables below gives the acoustic parameters that can be displayed in numeric or graphic format, with the respective abbreviations used to identify them.

ACOUSTIC DESCRIPTORS (NUMERIC DISPLAY)

Instantaneous acoustic levels updated every 0.5s

Wideband

PARAMETER	ABBREV.	DEFINITION	WEIGH. FREQ.	WEIGH. TEMP.
L _{Xeq(Short)}	LeqS dBX	Short equivalent level (0.5s)	X=Z, C, A	-
L _{XYp}	LYp dBX	Sound pressure level (SPL) ⁴	X=Z, C, A	Y=F, S, I
L _{Xpk}	Lpk dBX	Instantaneous peak level	X=Z, C	-

Integrated acoustic levels

Wideband

PARAMETER	ABBREV.	DEFINITION	WEIGH. FREQ.	WEIGH. TEMP.
L _{Xeq}	Leq dBX	Equivalent continuous level	X=Z, C, A	-
L _{XYmax}	LYmx dBX	Sound pressure maximum level (SPL _{max})	X=Z, C, A	Y=F, S, I
L _{XYmin}	LYmn dBX	Sound pressure minimum level (SPL _{min})	X=Z, C, A	Y=F, S, I
L _{Xpkmax}	Lpkmx dBX	Peak maximum level ⁵	X=Z, C	-
L _{nn}	Li, i=1÷4 nn%	nn% percentile with nn=1÷99 ⁶	A	F

A weighting

PARAMETER	ABBREV.	DEFINITION	WEIGH. FREQ.	WEIGH. TEMP.
L _{AE}	LE dBA	Exposure level throughout the measurement time (SEL)	A	-
Dose % _A	Dose %	Dose percentage with programmable exchange rate, threshold level and criteria	A	-
Dose % _{A,d}	Dose,d %	Daily estimated dose with programmable exchange rate, threshold level and criteria	A	-
LA _{Ieq}	LeqI dBA	A weighted equivalent continuous level with Impulse time constant	A	I

Other

PARAMETER	ABBREV.	DEFINITION	WEIGH. FREQ.	WEIGH. TEMP.
Overload %	OL %	Percentage of the measurement time in which an overload occurs	-	-

⁴ The maximum reached level every 0.5s is sampled 128 time per second.

⁵ The maximum reached level every 0.5s is sampled 128 time per second.

⁶ It is possible to program up to 4 different percentile levels.

ACOUSTIC DESCRIPTORS (GRAPHIC DISPLAY)

Time Profile

Wideband Levels

PARAMETER	ABBREV.	DEFINITION	WEIGH. FREQ.	WEIGH. TEMP.
L_{AFmax}	L_{Fmx} dBA	Sound pressure maximum level (SPL_{max}) ⁷	A	F

Statistic analysis

PARAMETER	ABBREV.	DEFINITION	WEIGH. FREQ.	WEIGH. TEMP.
L_{Xpk}	L_{Xpk}	Peak level	X=Z, C	-
L_{Xeq}	L_{Xeq}	Equivalent level	X=Z, C, A	-
L_{XFp}	L_{XFp} dBX	Sound pressure level with FAST time constant (SPL)	X=Z, C, A	F

ACOUSTIC DESCRIPTORS THAT CAN BE STORED

Measurement group acoustic Levels

All the levels that can be displayed, above, related to the SLM and PROFILE,.

Report group acoustic levels

5 selected parameters

PARAMETER	ABBREV.	DEFINITION	WEIGH. FREQ.	WEIGH. TEMP.
L_{Xeq}	L_{eq} dBX	Equivalent continuous level	X=Z, C, A	
L_{XYmax}	L_{Ymx} dBX	Sound pressure maximum level (SPL_{max})	X=Z, C, A	Y=F, S, I
L_{XYmin}	L_{Ymn} dBX	Sound pressure minimum level (SPL_{min})	X=Z, C, A	Y=F, S, I
L_{Xpk}	L_{pk} dBX	Peak maximum level	X=Z, C	
SEL	LE dBA	Sound exposure level	A	
L_{nn}	$L_i, i=1\div 4$ $nn\%$	$nn\%$ percentile with $nn=1\div 99$ ⁸		
L_{Aeq}	L_{eqI} dBA	A weighted Equivalent continuous sound pressure level, with Impulse time constant.	A	I

⁷ It's displayed the maximum level every 0.125s sampled 128 times per second.

⁸ It is possible to program up to 4 different percentile levels.

Average spectrum (AVR) by octave and one-third octave bands

Statistical analysis on a selected parameter

PARAMETER	ABBREV.	DEFINITION	WEIGH. FREQ.	WEIGH. TEMP.
L _{Xeq}	Leq dBX	Equivalent continuous level	X=Z, C, A	
L _{XF}	LFp dBX	Sound pressure level with FAST time constant (SPL _{FAST})	X=Z, C, A	F
L _{Xpk}	Lpk dBX	Peak level	X=Z, C	

Event group acoustic parameters

5 selected parameters

PARAMETER	ABBREV.	DEFINITION	WEIGH. FREQ.	WEIGH. TEMP.
L _{Xeq}	Leq dBX	Equivalent continuous level	X=Z, C, A	
L _{XYmax}	LYmx dBX	Sound pressure maximum level (SPL _{max})	X=Z, C, A	Y=F, S, I
L _{XYmin}	LYmn dBX	Sound pressure minimum level (SPL _{min})	X=Z, C, A	Y=F, S, I
L _{Xpk}	Lpk dBX	Peak maximum level	X=Z, C	
SEL	LE dBA	Sound exposure level	A	
LA _{Ieq}	LeqI dBA	A weighted Equivalent continuous sound pressure level, with Impulse time constant.	A	I

Average spectrum (AVR) by octave and one-third octave bands

Statistical analysis on a selected parameter

PARAMETER	ABBREV.	DEFINITION	WEIGH. FREQ.	PARAMETER
L _{Xeq}	Leq dBX	Equivalent continuous level	X=Z, C, A	
L _{XF}	LFp dBX	Sound pressure level with FAST time constant (SPL _{FAST})	X=Z, C, A	F
L _{Xpk}	Lpk dBX	Peak level	X=Z, C	

A2. MEMORY CAPACITY DURING THE LOGGING FUNCTION

The 2010UC/A can automatically store data according to two different modes. **The sound level meter storage capacity when in Continuous Recording mode is equal to 23 hours with the supplied memory of 4 MB.**

The table below gives the sound level meter storage capacity in Auto-Store mode, recording automatically, at the end of each period equal to the set integration time, the SLM screen parameters with average spectra (AVR) by octave and by third octave bands. The storage capacity is expressed as the time necessary to get the memory full. For this calculation the “Third Octave” option is considered active”.

Integration Interval	Capacity
5s	> 45 hrs
1m	> 23 days
5m	> 4 months
30m	> 2 year

The storage of *Reports* and *Events* is made by units (record) which are recorded corresponding to each interval (Menu >> Instrument >> Measurements >> Report Time) or for each event. Each unit is made of one Header followed by the parameters enabled in the Menu >> Data Logger >> Report and >> Event. The following table explains the memory occupancy (in byte) for each block composing one unit (record).

Report or Event	Occupancy [bytes]
HEADER	7
PARAMETERS	10
OCTAVE SPECTRUM	24
THIRD OCTAVE SPECTRUM	66
STATISTIC	481

From the table it's possible, for example, to calculate the memory occupancy for reports recording, every 10 minutes (Menu >> Instrument >> Measurements >> Report time >> 10 min), including the 5 PARAMETERS (Menu >> Data Logger >> Report >> Parameters >> ON), spectrum in THIRD OCTAVE (Menu >> Data Logger >> Report >> T.Oct.Spectrum >> ON) and STATISTICAL ANALYSIS (Menu >> Data Logger >> Report >> Statistics >> ON):

$$6 \cdot (7 + 10 + 66 + 481) = 3384 \text{ byte/h} \gg \text{maximum duration} = 4 \text{ MB} / 3384 \sim 51 \text{ days}$$

An additional 4MB expansion memory is available as an optional accessory doubling the memory capacity.

A3: THE SOUND

The sound is a variation of pressure audible by the human ear. Its propagation, starting from the source, occurs in the form of waves and is thus subject to all the phenomena typical of the waves, such as refraction and diffraction. The propagation speed depends on the medium and, in the air, at ambient temperature, it equals to about 344 m/s.

The ear sensitivity is quite high and able to perceive pressure variations equal to about 20 μPa , corresponding to 5 parts a milliard of the atmospheric pressure. This incredible sensitivity is joint to the capacity to bear pressure variations more than one million times higher. For convenience, it was decided to indicate the sound pressure level in decibel rather than pressure in Pascal, in order to reduce the numeric extension.

The decibel (dB symbol) is defined by:

$$dB = 20 \cdot \log_{10} \frac{X}{X_0}$$

where: X is the measured quantity.

X_0 is the reference value of the measurement (to which corresponds 0 dB).

In acoustics, the pressure is the measured quantity and the reference value corresponds to 20 μPa , the minimum audible pressure. Therefore the sound level corresponding to a 20 μPa (0.00002 Pa) pressure variation will be indicated as 0 dB. The sound level corresponding to a 20 Pa sound variation will be indicated with 120dB, a level at the limit of the pain threshold.

An increase by 10 times of the sound pressure corresponds to a level increase by 20 dB, while an increase by 100 times of pressure corresponds to an increase in level by 40 dB: the sound level increases by 20 dB against each increase of a factor 10 of the sound pressure. Similarly, the increase of the level is equal to 6 dB for each doubling of the sound pressure.

The use of decibels to indicate the sound level has, besides the evident advantage to reduce the measurement numeric range, the advantage of providing a good approximation of the audible perception that follows the sound pressure on a logarithmic scale.

Not all pressure variations are audible. When a pressure variation is due, for example, to climatic variations, it changes too slowly to be heard, but, if it is fast, like, for example, that produced by striking the drum or by bursting a balloon, it can be heard by the human ear and is consequently identified as a sound.

The number of pressure oscillations/second is called sound frequency and is measured in cycles per second or Hertz (Hz). The audible frequency range extends between approximately 20 Hz up to 20 kHz. Under 20 Hz we enter the infrasound field, while over 20 kHz we enter in that of ultrasounds.

Hearing sensitivity is not constant throughout the whole range of audio frequencies, but it shows a consistent loss at very low or high frequencies. Sensitivity is at its maximum in the range between 1 kHz and 5 kHz. The variation of auditory sensitivity according to sound frequency also depends on the sound intensity. “Isophone” curves (equal loudness level contours), defined in ISO 226:2003 standard, are shown in the following graph and provide the sound pressure level giving the same audibility (loudness) at different frequencies. The dotted curve, named MAF (Minimum Audible Field) indicates the minimum audible threshold.

Music, voice and noises in general are usually distributed throughout a wide interval of frequencies. Borderline cases are: the “pure tone”, a sound made up by a variation of pressure at a given frequency; and the “white noise”: a sound uniformly distributed throughout all frequencies (it sounds like the TV audio rustling when it is not tuned in any station).

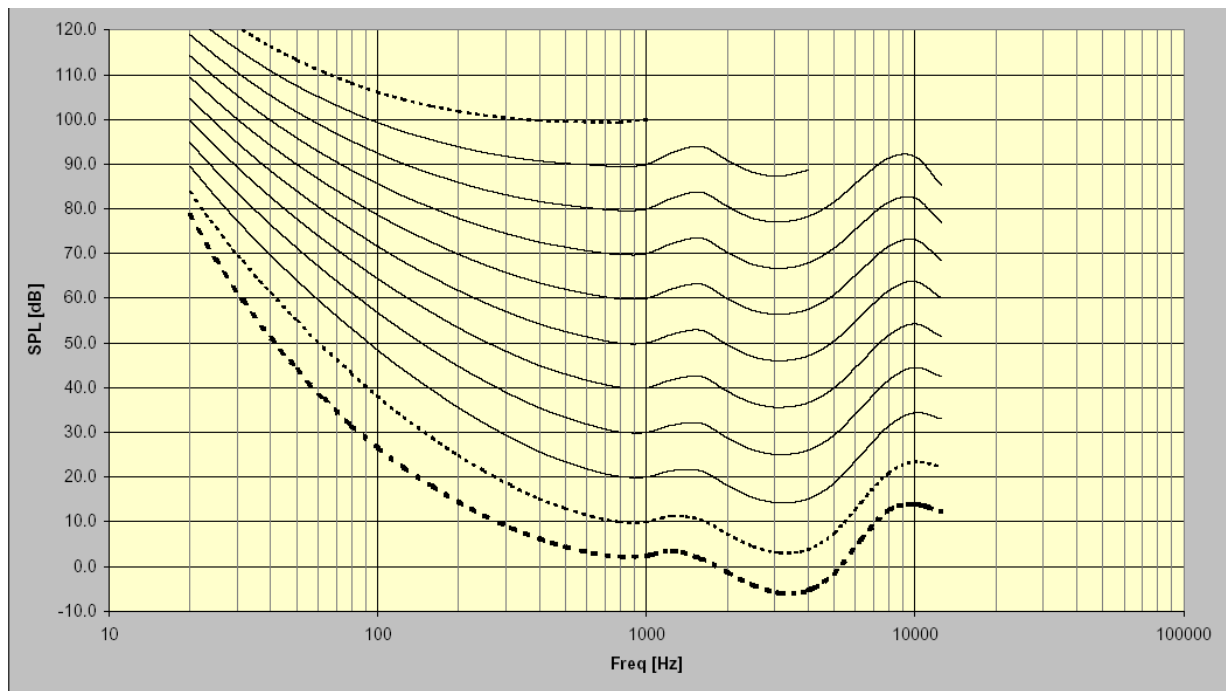

Noises characterized by the presence of a pure tone, are more bothering, at the same level, with respect to noises distributed over a wide interval of frequencies. The reason is to be found in the sound energy “concentration” in the ear mechanics.

Usually, the sound level is not static, but it changes with time. If the variation is very rapid, the ear cannot feel the real intensity. In case of sound pulses, we know that the ear has a reduced perception already for durations lower than 70 ms. For this reason, noises with an impulsive feature are usually considered, at the same level, more dangerous.

A4: SOUND LEVEL METER

The sound level meter is the instrument that measures the sound level. Usually, it is made up by a microphone, the sound sensitive element, by an amplifier, by a signal processing unit and by a reading and data display unit.

The microphone converts the sound signal into a corresponding electrical signal. The sensitivity of microphones for level measurements does not depend on the sound signal frequency. The preference of the type of microphone is usually based on the condenser type that grants excellent features like accuracy, stability and reliability.

The amplifier is necessary to bring the electrical signal to measurable amplitude and to strengthen the signal to allow cable transmission.

The processing unit takes care of calculating all measuring parameters necessary to characterize a sound event.

FREQUENCY WEIGHTING

If you have to assess the auditory impact of a noise source, you will have to make some corrections to the acoustic signal provided by the microphone in order to simulate the sound perception; this means that the microphone sensitivity will have to be adjusted to simulate the frequency response of the human ear. Two correction curves named “A weighting” and “C weighting” have been defined as international standard (IEC 60651, recently replaced by IEC 61672).

When the sound level is corrected by A weighting, it is referred to as L_{Ap} , and simulates the perception of low sound levels. When, on the contrary, the sound level is corrected by C weighting, it is referred to as L_{Cp} , and simulates the perception of high sound levels.

When there is no interest in sound perception, measurements are carried out using Z weighting (LIN for IEC 60651) that represents a constant response to all frequencies in the sound field.

SPECTRAL ANALYSIS

The spectral analysis by bands is used to analyze in detail the features of a complex sound. For this analysis the range of audio frequencies (between 20 Hz and 20 kHz) is divided into bands, typically with a constant percentage bandwidth corresponding to an octave or to a third octave. The sound level is calculated for each band considering only the noise components with frequencies included within the band limits: for octave bands the upper limit always equal the double of the lower limit, while for the third octave bands, the upper limit equals 1.26 times the lower limit, so that an octave band is divided into three third octave bands. For example, the band centered at 1 kHz will consider the sounds between 707 Hz and 1414 Hz for octave and between 891 Hz and 1122 Hz for third octave bands. The analysis result is usually shown in a graph called “spectrogram” where the sound levels are represented in graphic format for each of the bands in which the sound spectrum has been divided. The division of the spectrum into bands and the specifications of the pro-

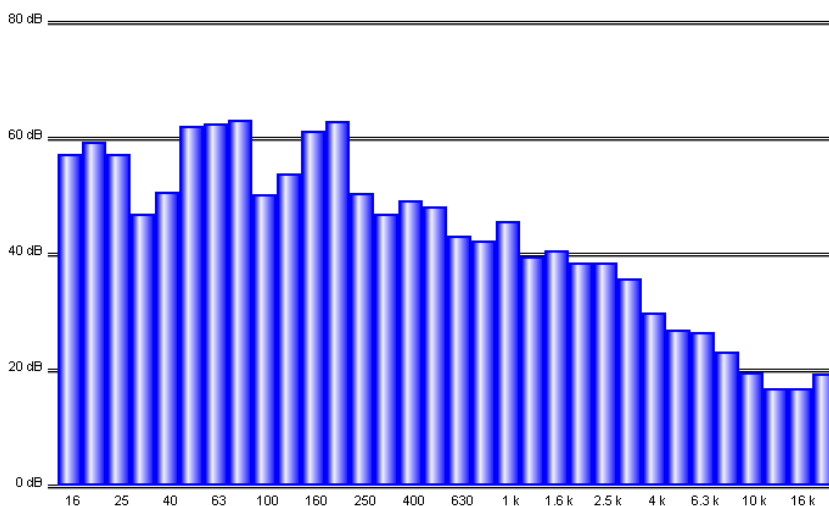

cedure has been divided. The division of the spectrum into bands and the specifications of the pro-

cessing unit that calculates the “spectrograms” have been defined by IEC 61260 international standard.

TIME CONSTANTS AND EXPONENTIAL WEIGHTING

Further processing of the microphone signal is needed when fluctuating sound levels have to be measured. To evaluate a sound level varying with time, two types of instantaneous responses have been defined by international standards (IEC 60651/IEC 61672). One, named FAST, simulates the ear response, the other one, named SLOW, provides a sound level quite stable even in case of fluctuating noises.

The choice of the type of response of the level meter combines with the selection of frequency weighting to provide a wide spectrum of possible measuring parameters; for example, the A weighted sound level will be measured with a FAST time constant (L_{FAp}) to simulate the auditory sensation. The FAST time constant is equal to 0.125s, while the SLOW constant equals 1s.

When measurements with a FAST time constant are carried out, the instantaneous sound level will be strongly affected by the pressure trend in the last octave of second, while it will not be affected by what happened more than one second before.

The sound level with a SLOW time constant will strongly depend, instead, on the trend of pressure in the last second, while it will not be affected by sound events occurred more than 10 seconds before. We can say that the sound level with a SLOW constant is approximately an average of the instantaneous levels of the last second.

IMPULSIVE NOISES

If the sound has a short duration, it is called **impulsive**: i.e.: writing with a typing machine, the noise caused by a hammer or by a gun are classified as impulsive sounds. To assess their impact on the auditory apparatus, consider that the more the sound is short, the less the ear can hear it. For this reason, a time constant has been defined in the international standards (IEC 60651/IEC 61672), called IMPULSE, very fast (35ms) for increasing sound pressure levels and very slow (1.5s) for decreasing levels.

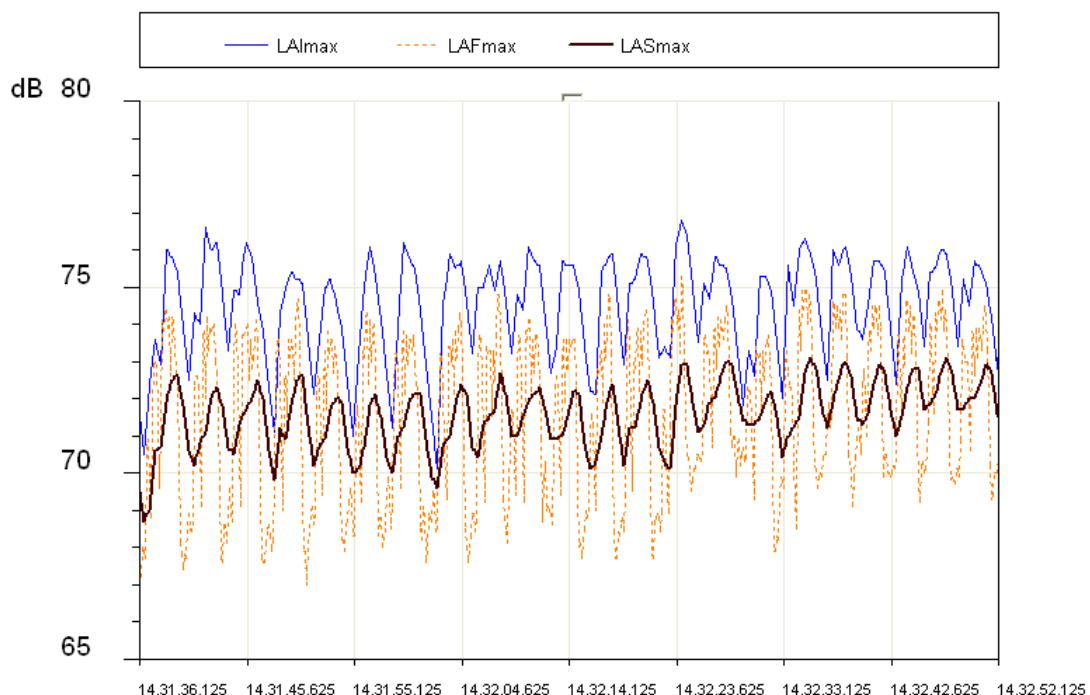

In case a sound source emits noises with a strong impulsive component, the level measured with the IMPULSE constant will be much higher than the SLOW level. The figure shows the sound level profile, measured simultaneously using the FAST, SLOW, and IMPULSE time constant by a surface mount machine.

The displayed levels are the maximum levels calculated on intervals equal to 1/8s. The most variable profile is the FAST profile (8dB) while the less variable is the SLOW one (3dB). The IMPULSE profile is systematically higher than FAST and SLOW, as it reflects the impulsive nature of the noise issued by the machine.

Impulsive sounds, independently on their spectrum, are more dangerous for the human ear, as the energy involved, in the short time-lapse in which they develop, does not allow the ear to take any defence. Therefore, the equivalent level being equal, a noise source containing impulsive components is generally penalized.

Unfortunately, while the ear sensitivity decreases according to the duration of noise, the risk of an auditory injury does not decrease. For this reason, sound level meters usually have a built-in circuit for the measurement of the acoustic signal peak value.

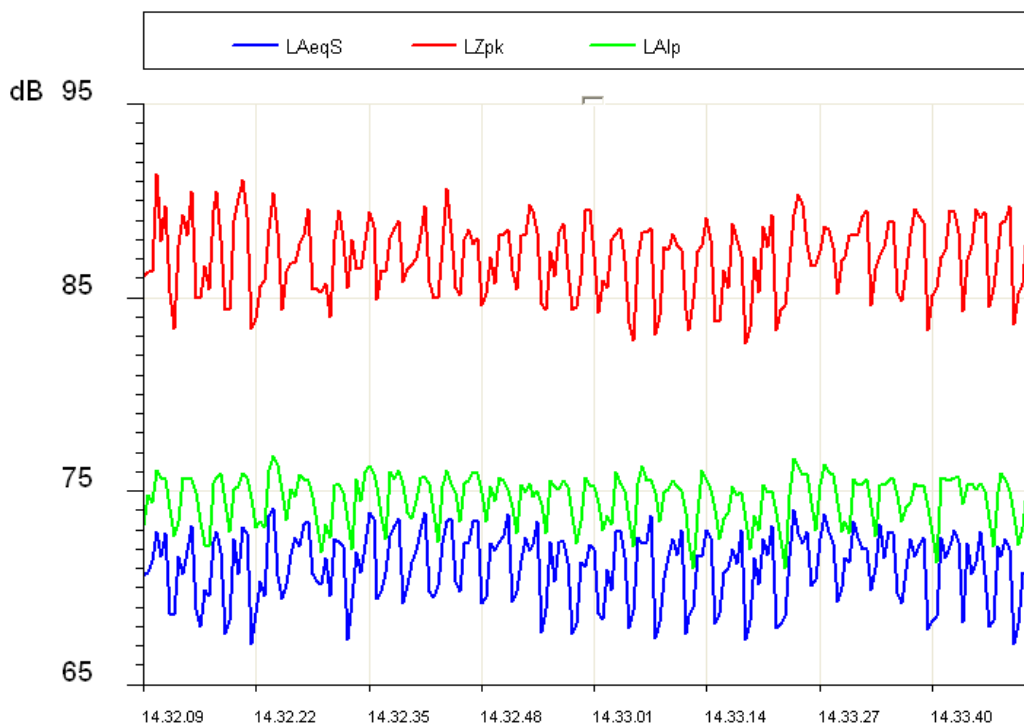

The non-weighted peak level and the IMPULSE level relevant to the surface mount machine are illustrated in the figure. As you can see, the peak level is at least 10 dB higher than the IMPULSE level. The parameter “PEAK”, referred to as L_{pk} has been defined in the international standards (IEC 60651/IEC 61672). It provides the peak level reached by the sound pressure in a given time interval. The response time of the peak level is very fast ($<100\mu s$) and it is able to measure the sound level of very short sound events (for example, a gunshot) with sufficient accuracy.

EQUIVALENT CONTINUOUS SOUND PRESSURE LEVEL

The approximation obtained by considering the levels with FAST or SLOW time constant as short-term averages is quite rough. If the sound during its propagation transports energy, it is important to account for the duration of the sound event in order to interpret the energy content correctly.

This is particularly important in assessing the impact of the sound produced by machines or general pollution sources on the auditory apparatus. It is obvious that a strong noise generates a

growing damage proportional to exposure. Evaluation of potentially harmful noise is therefore easy with constant level sounds.

If the sound varies in time you have to use a measurement parameter, defined in the international standards (IEC 60804, recently replaced by IEC 61672), called “equivalent level”, symbol L_{eq} . The equivalent level is defined as the constant level having the same energy content of the fluctuating level in the period being examined. The A weighted equivalent level (L_{Aeq}) will be used to measure the energy content, and then the harmful potential, of a fluctuating noise source during a given period.

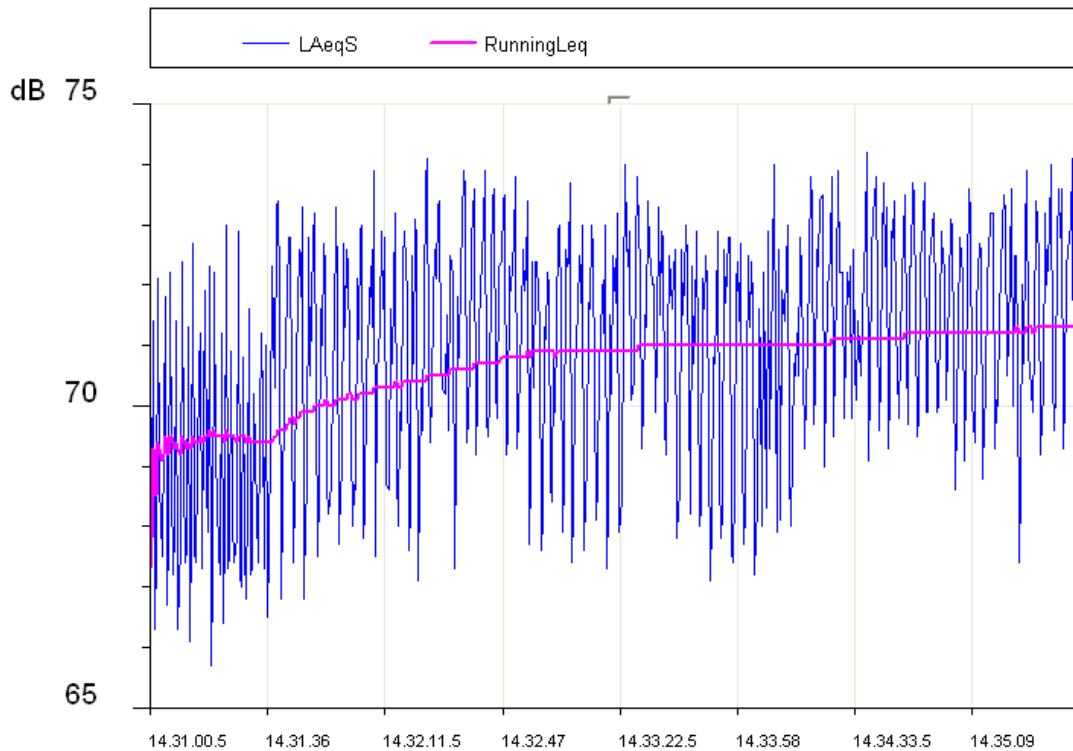

In the figure, the equivalent level profile is highlighted. It is stabilizing within few minutes to a level just above 71dBA.

Considering an intermittent source of noise (for example a train passing by), it is obvious that the equivalent level can give a measurement of the mean energy level after considering many passages.

If you wish to measure the energy content of a single passage, you need to use a different measurement parameter, the “Sound Exposure Level”, symbols SEL or L_E (IEC 60804/IEC 61672). The sound exposure level is defined as the constant sound level for 1 second that contains the same energy of the event being examined. By standardizing the SEL value (1 second), it is possible to compare sound events with different durations.

STATISTICAL ANALYSIS

If you need to examine, from a statistical viewpoint, the distribution in time of the sound pressure level, you have to use the percentile levels. A percentile level, symbolized as L_x is defined as the sound level being exceeded by the X percentage during the total time. To calculate the percentile levels you first need to classify the sampled sound level according to regular intervals (usually 1/8s) in width classes, usually between 0.1dB and 2dB. At the end of the acquisition the probability for each class is calculated by dividing the sampling frequency by the total number of samples. The result is the sound level distribution of probabilities shown.

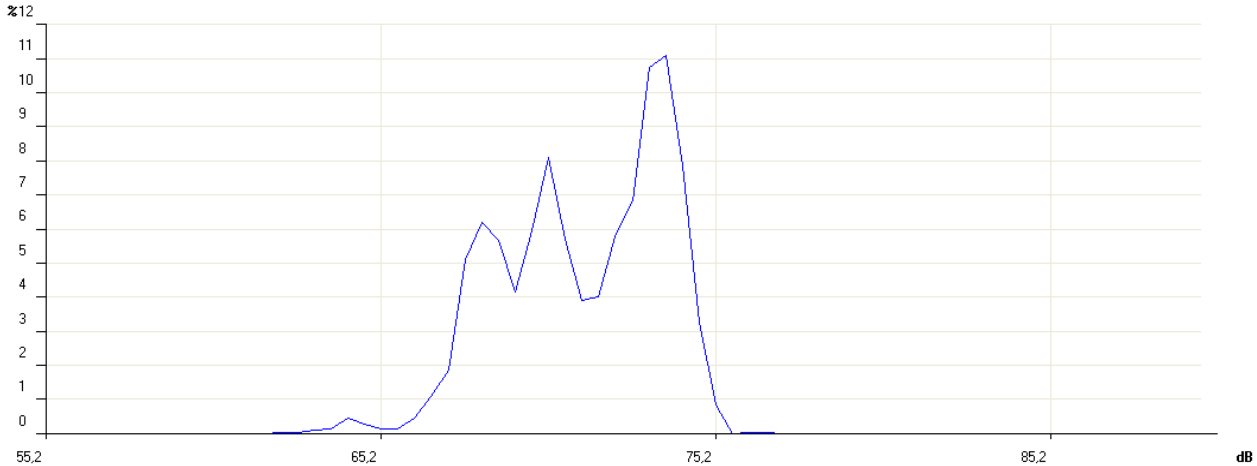

After this, the cumulative distribution is calculated. This is based on the sound level distribution of probabilities, beginning with a 100% probability for all lower classes with a value lower than the minimum measured level and for each class progressively subtracting the corresponding distribution probability of the level probabilities.

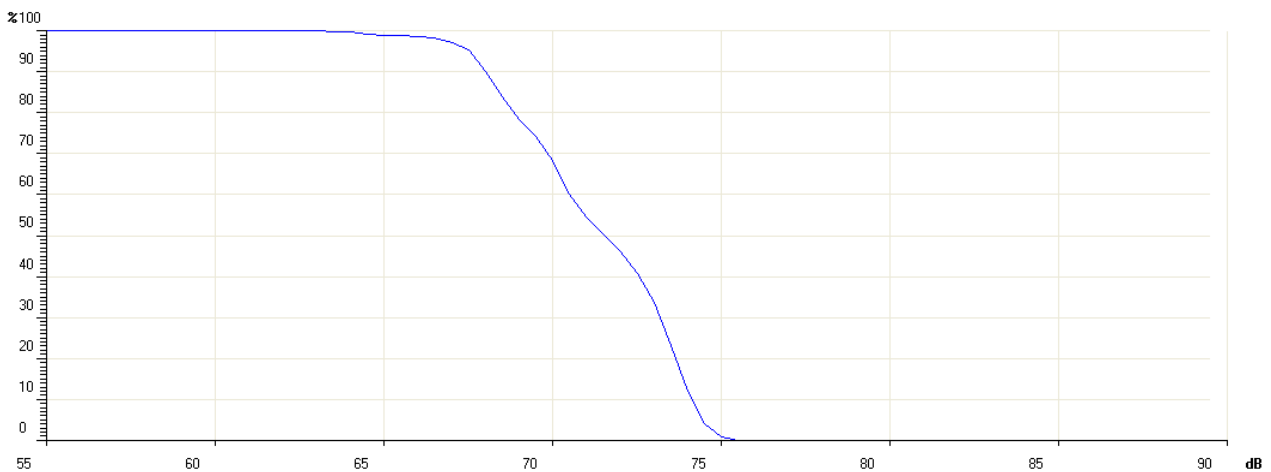

The cumulative probability will be null for levels higher than the maximum measured level. The percentile levels are calculated interpolating the cumulative distribution. For example, if from the analysis of the noise of a traffic road you detect that, the sound level (usually A weighted, examining the auditory impact), remains higher than 74dB half the time, the percentile level L_{50} is 74dB.

The integrating sound level meters directly supply the time integrated parameters, such as equivalent level and sound exposure level, in addition to maximum and minimum. On the other hand, the statistical analysis is a prerogative of statistical analyzers.

NOISE DOSE

The measurement of the “Dose” of noise is used in the field of noise monitoring in a working environment, meant as a percentage fraction of a maximum daily exposure to noise. The organizations taking care of safety in working environments have defined some standards for the measurement of the noise dose considering the energy content of sound pressure and comparing it with a maximum daily equivalent level (over an 8-hour time interval) that is, in Italy, equal to 85 dBA (A weighted equivalent level) when no hearing protection is available.

ISO 1999 standard, considering only sound energy, sets out that an increase of 3 dB in the sound level halves the exposure time, to keep the dose equal. Italy applies ISO 1999 definition. Health corporations in other countries have adopted a different principle that takes into account the ear recovery times during pauses and allow to increase the level by 4 dB (DOD) or 5 dB (OSHA) before halving the exposure time.

ACOUSTIC FIELD

Sensors and transducers in general are designed not to disturb the physical quantity to be measured. Exactly as a thermistor would limit to the minimum the temperature disturbance caused by its presence, also the microphone is designed not to alter heavily the acoustic field where it works. The alteration of acoustic field becomes important at frequencies corresponding to sound pressure wavelengths comparable to the microphone dimensions (diffraction phenomenon). For example, with 10 kHz, sound pressure wavelength equals about 3.4 cm, comparable with the dimensions of a typical microphone.

Essentially, there are two types of acoustic fields: the “free field” and the “diffuse field”. The field is defined “free” when the sound level decreases by 6 dB doubling the distance from the source. This condition is usually met with a good approximation at a distance from the source higher than its bigger dimension and, in any case, higher than the bigger wavelength of the generated noise.

The free field is significantly disturbed by the closeness of rigid walls, capable of “reflecting” sound levels comparable with those due to the acoustic pressure waves coming directly from the source.

The acoustic field in an environment where sound waves reflected by walls are dominant and, therefore, where the sound level is determined by sound pressure waves coming from all directions, is called “diffuse field”. While measurements in indoor environments are usually treated as diffuse field measurements, those outdoor are generally treated as free field measurements.

Since the microphone has dimensions comparable to the highest frequencies of the sound spectrum, it is designed to get an optimized response for a given acoustic field.

There are three types of microphone: for free field, diffused field and pressure.

The *microphone for free field* is designed to have a constant sensitivity at any sound field frequency for sound signals coming from the front side, making automatic adjustments to high frequencies to compensate the increase in pressure at the membrane level, due to its presence.

The *microphone for diffuse field* is instead designed to have a constant sensitivity at all frequencies for sound signals coming from all directions.

The *microphone for pressure measurements* is used for laboratory measurements even though, having a characteristic similar to that of a microphone for diffuse field, might also be used in reverberant fields.

When a diffuse field microphone is used in free field, it usually provides precise values when it is oriented at 70° - 80° compared to the sound source. If it is pointed to the source direction, it provides too high values, mainly at high frequency. Vice-versa, a microphone optimized for the free field will provide too low values when measuring in reverberant fields and in all cases in which it will not be oriented towards the sound source.

Modern sound level meters, like HD2010UC/A, apply corrections that can modify microphone responses according to the acoustic field in which they are used. In this way you can, for example, make measurements in indoor environments, in presence of multiple sound sources and anyway in a reverberant field, with a microphone optimized for free field, by activating the correction specific for random incidence. Applying this adjustment, the free field microphone will give a response similar to that of a diffuse field microphone.

ENVIRONMENTAL INFLUENCE

Temperature

Sound level meters are designed to work at temperatures included in the range: $-10^{\circ}\text{C} \div +50^{\circ}\text{C}$. Most accurate sound level meters, like HD2010, can have adjustment circuits for thermal drifts aiming to reduce at minimum the measuring error over the whole temperature range. It is suggested, however, to avoid sudden variations that might cause condensation. Furthermore, be sure that the instrument is in thermal equilibrium before carrying out a measurement or a calibration (just wait an hour after temperature has changed).

Humidity

The HD2010UC/A sound level meter and the microphone are not affected by relative humidity up to 90%. However, protect the microphone from rain and snow and keep it clean. In case of bad weather, it is suggested to use a windshield and, in case of use in very humid environments, the proper microphone dehumidifier should be applied.

Pressure

Microphone sensitivity depends on atmospheric pressure. Microphone sensitivity depends on atmospheric pressure. Sensitivity increases as pressure decreases and the change of sensitivity for the HD2010UC/A with the UC52 microphone measured at 250 Hz is always lower than ± 0.03 dB/kPa in the range 85 kPa \div 108 kPa as required by IEC 61672 for Class 1 sound level meters. Sensitivity drift with ambient pressure is usually worst at high frequencies, even if the sensitivity maximum difference in the range 85 kPa \div 108 kPa remains within ± 0.5 dB over the whole sound spectrum.

Wind

To reduce wind disturbance as much as possible, it is suggested to use the proper windshield, consisting of a polyurethane porous globe to be placed on the microphone.

This useful accessory protects also from dust, dirt, rain and snow. The presence of a windshield slightly alters the microphone frequency response and more accurate sound level meters are provided with a correction curve to compensate this effect.

Vibrations

Even though microphone and sound level meter cannot be easily affected by vibrations, it is better to isolate both instrument and microphone from strong vibrations.

Magnetic Fields

The influence of electrostatic and magnetic fields on the sound level meter is negligible.

PRECAUTIONS AND GENERAL HINTS OF USE

- Ensure that ambient conditions fit the use of a sound level meter. Take care that the instrument has reached thermal equilibrium, that there is no condensation on metal walls and that tempera-

ture, relative humidity and pressure are within the limits specified by the manufacturer. The use of the sound level meter in conditions of high humidity with consequent condensation can cause damages.

- Check the battery level of both sound level meter and calibrator.
- Check that the sound level meter is calibrated by measuring the calibrator reference sound level. This inspection has to be repeated at the end of measurements to assure the sound level meter stability.
- Use the windshield, when necessary. The shield grants a good protection against shocks. Its use is suggested also indoor, above all in presence of machines with mechanical parts in movement. When available, activate the proper adjustment on the sound level meter, to compensate the shield effect on the microphone frequency response.
- Determine the type of acoustic field where you have to operate and eventually apply the corrections that the sound level meter provides. Consider the measuring environment, the kind of sound source and the position in which measurements are carried out.
- Position the microphone according to the type of acoustic field considering also the correction made by the sound level meter, if any.
- The choice of frequency weighting and of time constant usually depends on the standard used to carry out measurements.
- Consider that the presence of an operator during measurement alters the sound field: thus keep the instrument as far as you can from your body. For better accuracy, position the sound level meter on the tripod, especially for spectral analyses. Best results are obtained if only the preamplifier is mounted on the tripod and the extension cable is used to connect it to the instrument.

CLASSIFICATION OF ACOUSTIC SIGNALS

Acoustic signals can be classified according to the possible analysis techniques. First of all we can divide the acoustic signals into two classes: stationary and non-stationary signals.

Stationary Signals: these are the signals which average values (mean value, equivalent value, etc.) do not depend on time.

Among the stationary signals there are the deterministic and the random signals.

Deterministic Stationary Signals: these are the stationary acoustic signals that can be described with a function of time that is as a sum of sinusoidal signals. These signals are periodical if the sinusoidal components are all multiples of a main frequency. They are also called “quasi periodical”.

Random Stationary Signals: these are the signals that can be described only in statistical terms.

Among the non-stationary signals can be identified continuous and transitory signals.

Continuous Non-stationary Signals: these are the signals that never have a null value.

Transitory Non-stationary Signals: these are the signals that have a non-null value only in determined time intervals.

Stationary signals can be analyzed over different time intervals obtaining comparable and repeatable mean levels. A frequency analysis can be made with a sequential spectrum analyzer, measuring the sound level band by band until the interested spectrum is covered. Spectra of periodical stationary signals will be striped, which means that they will have non-null levels only in the bands with

characteristic nominal frequencies. Random stationary signals will have instead a continuous spectrum.

An example of deterministic stationary signals could be a note or a chord played by a musical instrument, while for random stationary signals the example might concern car traffic noise or air-conditioning noises.

Non-stationary signals have sound levels depending both on the period of measurement and on integration time. The time taken for the analysis is critical for this type of acoustic signals and the frequency analysis has to measure all levels in every band of the spectrum at the same time. The analyser suitable to this kind of measurement is called to operate in “real time”. Among the non-stationary signals we can include talking or impulsive signals, such as a balloon burst. The calculation of integrated mean values over a given time interval might be used in spectral analysis of deterministic stationary signals, according to the signal main frequency. If the average time is at least 3 times higher than the acoustic signal main period, level oscillations are considered negligible. To get stable and repeatable levels, the integration time can be adjusted. In this case, consider that the uncertainty in determining sound levels will depend not only on the integration time, but also by the bandwidth of the filter being examined. In the case of the white noise, the following formula provides the uncertainty due to the statistical error.

$$u_s = \frac{4.34}{\sqrt{B \cdot T_{\text{int}}}}$$

The following table, as an example, gives such uncertainty for some filters with constant percentage bandwidth of a third octave for some integration times.

T_{int} [s]	Central Frequency [Hz]						
	16	31.5	63	125	250	500	2k
0.5	-	-	-	1.1	0.8	0.6	0.3
1	-	-	1.1	0.8	0.6	0.4	0.2
4	1.1	0.8	0.6	0.4	0.3	0.2	-
20	0.5	0.4	0.3	0.2	-	-	-
100	0.2	0.2	-	-	-	-	-

Some acoustic signals can be analyzed in statistical terms. The statistical analysis provides information complementary to that provided by the calculation of the equivalent level for signals strongly time dependent. Actually, signals with completely different time evolutions, and, consequently, with an impact completely different on the auditory apparatus, can have the same equivalent level. For example, in the analysis of the noise made by car traffic it is convenient to measure the so called “statistical levels” (or “percentile levels”) providing a description of noises fluctuating in time.

The statistical levels provide the sound level exceeded by a certain percentage of the measuring time, and are represented with the symbol L_x, where x is the percentage value; for example L₁₀ gives the sound level exceeded in the 10% of the measuring time. For the calculation of the percentile levels, the analyzer makes a sampling of the L_p sound level, with FAST time constant and A frequency weighting, at a frequency usually equal to 10 Hz.

Sound levels measured in this way are classified over the whole measurement range according to given amplitude intervals, usually a fraction of decibel, called classes. When starting the measurement all classes will have a null number of samples, while at the end of measurements, the classes will contain a number of samples depending on the rate with which a sound level has been measured inside the respective interval.

At the end of the measurement time, the distribution of probabilities will be first calculated, dividing the content of any class by the total number of samples and multiplying the result by 100;

then the cumulative distribution of probabilities will be calculated, having a value of 100% for levels lower than the first class containing at least a sample and taking lower values down to zero for levels higher than the last class containing samples.

From the definition of the statistical levels it is evident that L_1 will be very near to the maximum measured level, while L_{99} will be very near to the minimum measured level. Therefore, while levels L_1 , L_5 and L_{10} are representative of the peaks of the acoustic signal, L_{90} , L_{95} and L_{99} are representative of the background noise.

Other parameters characterizing the sound level have been derived from the statistical levels. For example, in the measurement of vehicle traffic noise, the "Traffic Noise Index" has been defined as:

$$\text{TNI} = 4 \cdot (L_{10} - L_{90}) + L_{\text{eq}}$$

That provides higher values in the case of a sound level strongly fluctuating and thus characterized by a bigger difference between L_{10} and L_{90} .

A5: ARCHITECTURAL AND BUILDING ACOUSTICS

Introduction

The aim of studying acoustics in buildings is to improve living conditions. Architectural Acoustics studies both the diffusion of sound in enclosed spaces, in order to improve the sound quality of music and the spoken words, and to soundproof sound sources and insulation against undesired noises.

The purpose of studying sound diffusion in enclosed environments is to improve sound distribution and the quality of auditory perception, intelligibility of words and the control of echo, etc.

The main parameter that describes an enclosed space from an acoustic viewpoint is **reverberation time**. The difference between the perception of hands clapping in a common living room and a large hall, for example in a sports hall, forms part of the experiences we all feel. The phenomenon needs to be interpreted by thinking of the sound wave propagation interacting with the walls and gives sound that “colour” which allows us to evaluate the dimensions of the space even when we are blindfolded.

Soundproofing and **sound insulation** in enclosed spaces is being studied to reduce the interference between adjacent rooms or from external sources. The guiding principle is known as “passive defence”. It is assumed that possible intervention on noise sources, like vehicle traffic noise or noise emanating from industrial and commercial activities, are generally difficult or complex and therefore you have to intervene on the building to protect the people working and living there from the undesired noises, either external or from other parts of the building itself.

Therefore, studies have been carried out on both the acoustic insulation through the measurement of the *sound insulating power* of the materials that form the dividing walls, and secondly on their *sound absorption* through the measurement of the sound absorption coefficient. Absorbing elements reduce the reverberation time, and also generally reduce the sound pressure level in a closed environment. They are also used to insulate a noise source with respect to the surrounding space, thus reducing the noise reflected by the acoustic barriers.

Even though it is impossible to analytically describe the acoustic behaviour of an actual enclosed space, there are simplified models for the quantitative predictions in applied acoustics. Qualitatively the most important factors in the description of acoustic behaviour are **reflection** and **absorption** and the “**modes**” of the enclosed environment being tested.

Any solid body hit by a sound wave, acts on the wave through *reflection*, *absorption* and *transmission*. Part of the sound wave is reflected, part is absorbed by the material the solid body is made of; a fraction of the wave goes through the entire solid body and is thus transmitted by it.

Thinking about an enclosed space in which there is a sound source, the effect of the walls will be to reflect the incident sound that bouncing from wall to wall will propagate in all directions. The walls will also transmit part of the sound so that even in the rooms close to the one being examined, it will be possible to perceive the sound issued by the source. Finally, part of the sound energy will be absorbed by the walls themselves and dissipated as heat.

From the listener’s viewpoint the sound will be perceived first of all as coming directly from the source, but right after, with only a small delay, as coming from all the other directions. The perception delay between the direct sound wave and the reflected waves depends on the path travelled by the sound wave, propagating at a speed equal to 343m/s at normal temperatures. The well-known effect of the echo is associated to the delay time between the direct wave and the reflected wave equal at least to one twentieth of a second, with travel differences of at least 20m.

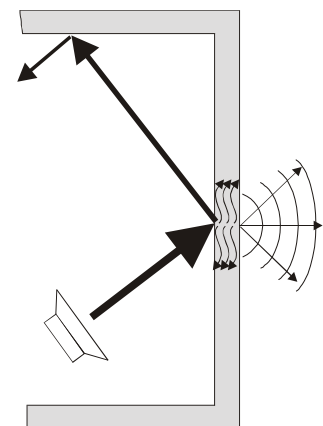

The absorption and the acoustic transmission is responsible for the progressive reduction of the sound wave at each interaction with the wall materials. Consequently, when the sound source is interrupted, after some time sound is no longer perceptible. The sound level will be maintained infinitely after the interruption of the sound source in an hypothetical room having walls with no absorption or transmission.

Modal Theory

By analyzing the sound level distribution in a room in which a sound source is operating, it can be seen that the sound level has highs and lows that depend on the position and dimensions of the room. This effect is explained by the **Modal Theory**.

This theory explains how the direct wave of the sound source combines with the waves reflected by the walls forming a series of maximum and minimum sound level spots. Therefore any enclosed space can be thought of as a multi-resonant system and so a certain number of resonance frequencies or characteristic “*modes*” of the room can be examined. These modes are distributed in the spectrum with a density proportional to the square of the frequency.

This implies that the sound level widely fluctuates from point to point in an environment where low frequency sounds having a stationary speed are issued. These fluctuations will decrease when the frequency of the sound issued by the source increases. Schroeder (1996) defined a characteristic frequency called “**Schroeder frequency**” above which it is possible to ignore the modal theory and therefore consider the sound field from a static point of view. This frequency is equal to:

$$f_{lim} \cong 2000 \left(\frac{T}{V} \right)^{1/2}$$

T = estimated reverberation time, V = volume in m³

This limit frequency divides the environments in two types: those of large dimensions, where consideration of modes has no significance, and small ones where the low frequencies field is important. While in the case of large dimension environments the acoustic field can be analyzed from a statistical point of view, in the case of small dimensions it is almost impossible to make any quantitative prediction about acoustic behaviour.

Definition of Reverberation Time

In technical acoustics measuring the speed with which, after the source has been turned off, the sound ceases in the environment is of primary importance. This measurement is performed calculating *the time required for the sound level in an observation point to decay by 60 dB, starting from the moment the source was turned off. Such a time interval is called “Reverberation Time”*.

The reverberation time is usually measured by exciting, up to permanent stationary conditions, the space examined using a wideband source so as to excite the most of resonance modes. The source is then abruptly interrupted and the sound pressure level decay is recorded, filtered by octave or third octave bands.

Analyzing the decay curve for central frequencies lower than the Schroeder frequency, non linear behaviours with double gradients can be seen, while for frequencies above the limit frequency the decay will be linear and therefore it will be much easier to measure its gradient and therefore obtaining the reverberation time. **According to ISO 3382**, when a *correlation coefficient below 0.95* is obtained calculating the linear regression on the sound level decay, it is not possible to define the reverberation time unambiguously.

For “large” dimension spaces, whose limits are defined by Schroeder’s frequency, the high modal density makes the sound field approximating a plane wave, propagating with equal probability in all directions, defined as “**diffuse field**”.

In practice, this approximation is valid above Schroeder’s frequency in environments that are not excessively absorbing and at a sufficient distance from the sound source and the walls. With this

approximation it is possible to calculate the reverberation time T starting from the geometrical characteristics of the room, using the **formula of Sabine**:

$$T = 0.161 \frac{V}{A}$$

where T is the reverberation time in seconds, V the volume in cubic meters and A the equivalent absorption area of the room in square meters:

$$A = \sum_i \alpha_i S_i$$

where the absorption of the room's walls and the possible objects in it are summed as indicated by S_i being the i -th surface with absorption coefficient α_i . The absorption coefficient is characteristic of the material and depends on the frequency and the sound incidence angle. Since the equivalent absorption area varies with the frequency, *the reverberation time also depends on frequency and is generally higher at low frequencies, which are usually more difficult to absorb compared to high frequencies.*

The reverberation time is one of the parameters used in the acoustic characterization of different environments such as class rooms, gyms and sports stadiums, congress and conference halls, theatres and rooms for shows, etc. The reverberation time is also used to measure other acoustic parameters of building materials such as the sound absorption, the airborne sound transmission, the impact sound insulation, etc. **The standard that defines the measurement of the reverberation time is ISO 3382:** "*Measurement of the reverberation time of rooms with reference to other acoustical parameters*" describing the possibility of performing the reverberation time measurement with two methods: the sound source interruption technique, meaning a stationary noise can be used, and the integrated impulse response technique which therefore implies an impulsive source can be used.

The sound level meter HD2010UC/A with the optional reverberation time measurement can measure the reverberation time using both the sound source interruption technique and the impulse source technique. The measurement is carried out in parallel for both wide band channels A, C and Z and for octave bands from 125 Hz to 8 kHz and third of an octave from 100 Hz to 10 kHz. The sound level is linearly integrated 32 times per second without interruptions and simultaneously on all measurement bands, allowing reverberation time measurements down to 0.37s. As the sound decay is measured for at least 5 seconds, the maximum reverberation time that can be measured according to ISO 3382 is equal to 12s, corresponding to the minimum decay allowed, equal to 25 dB.

A5.1 - MEASUREMENT OF THE SOUND ABSORPTION

The absorbing materials and elements are largely used in the acoustic modelling of building elements, above all the ceiling, every time the reverberated sound energy has to be reduced. Their use limits the reverberation time and, when placed at a given distance from the sound source, they help to diminish the total sound pressure level in the environment. The absorption of the sound energy issued is one of the methods used to reduce the noise level when the propagation of the sound occurs inside enclosed spaces such as ducts or when you need a soundproof booth. The absorbent materials can also be used to reduce the sound reflection on acoustic barriers. The reference standard is **ISO 354**.

Instrumentation and measurement conditions

The acoustic insulation coefficient can be measured using different methods each requiring different instrumentation. The **ISO 354** standard of 2003 describes a method based on reverberation time measurement while the **ISO 10534** standard describes a method based on simple measurements of the sound level.

ISO 354 Standard

The ISO 354 Standard: “*Acoustics - Measurement of sound absorption in a reverberation room*” was updated in 2003.

The method consists of measuring the variation of the reverberation time associated with the introduction of a sample of the sound absorbing material into the test chamber.

This procedure requires a test room with precise dimensions and acoustic absorption characteristics. The sound source used for the measurements must be as omnidirectional as possible, like that described in the ISO 3382. The measuring equipment consists of one or more microphones with optimized response for diffused field. The microphone used to take the measurements must be at least 1 m from the sample and the reflecting walls of the room and at least 2 m from the source. The provisions on the characteristics of the recording equipment are the same as for ISO 3382.

According to the formula of Sabine in the case of flat sound absorbing samples, the acoustic absorption coefficient is defined by the expression:

$$\alpha = \frac{55.3 V}{c S} \left(\frac{1}{T_s} - \frac{1}{T_e} \right)$$

where c is the sound speed (m/s) equal to $331.6+0.6 \cdot T(^{\circ}\text{C})$ (344 m/s at normal temperatures), α is the absorption coefficient of the sample with an area S (m²), V is the volume of the room (m³), T_s is the reverberation time with the material placed in the room and T_e is the reverberation time without the material. The measurements must be taken for octave bands from 125 Hz to 4 kHz or third octave from 100 Hz to 5 kHz.

ISO 10534-1 Standard

The ISO 10534 Standard: “*Acoustics – Determination of sound absorption coefficient and impedance in impedance tubes – Part 1: Method using standard wave ratio*” was issued in 1997.

According to this standard, a noise is generated inside a tube by placing a speaker at one end and a sample of the material to be analyzed at the other end. The acoustic absorption coefficient can be calculated from the ratio between the maximum and the minimum sound pressure inside the tube moving a microphone along the longitudinal axis.

This method has the advantage of being able to perform the measurement on small samples of material and takes advantage of not needing a test room. The repeatability of the measurement is optimum but gives, in this case, a measurement of the absorption coefficient only with a normal angle of incidence.

A5.2 - MEASUREMENT OF THE AIRBORNE NOISE SOUND INSULATION

Airborne propagation is the propagation of sound energy from the emission environment to the receiving one both directly or through dividing walls. Together with the measurement of the insulation from impact noises, it permits the classification of the acoustic insulation properties for the buildings. The reference standards are **ISO 140-3** and **ISO 140-4**.

Instrumentation and measurement conditions

The measurement of the airborne insulation consists either of lab measurements or on site measurements. In the laboratory the specific properties of the building materials are measured, while “on site” the installation techniques and performances of the materials used in the construction are checked. The necessary instrumentation to perform the measurements consists of a stable sound source with a white noise spectrum and measurement microphones conforming at least to class 1 specifications according to the IEC 651 and IEC 804 standards. The measurement equipment must be calibrated conforming to the IEC 942 standard.

The analysis of the frequency is done with 1/3 octave band filters satisfying the specifications of the IEC 1260 standard. The frequency range starts from at least 100 Hz and goes up to 5000 Hz.

ISO 140 Part 3 Standard – Lab measurements

ISO 140 Part 3: “*Acoustics - Measurement of sound insulation in buildings and of building elements - Part 3: Laboratory measurements of airborne sound insulation of building elements*” was issued in 1995.

The standard defines a laboratory method to measure the airborne *sound insulation* of the building elements such as walls, floors, windows and doors, façades, except for the elements classifiable as having small dimensions for which a special method is prescribed in ISO 140-10. The results obtained can be used to design and/or to classify such elements.

The *sound reduction index* “**R**” of the wall not only depends on the geometric and physical properties of the wall itself but varies with the frequency and original direction of the sound. **R** is experimentally determined in diffused field acoustic conditions using a room divided by a wall consisting of the dividing element. For each frequency band, once the average sound pressure levels of the disturbing environment L_1 and in the receiving environment L_2 are known, the *sound reduction index* R (dB) of the wall tested is obtained from the expression:

$$R = L_1 - L_2 + 10 \log \frac{S}{A_2}$$

where **S** is the surface of the dividing element and **A**₂ is the equivalent area of acoustic absorption of the receiving environment (m²). The equivalent area of acoustic absorption **A** can be calculated by measuring the reverberation time of the receiving room (where L_2 is measured) and using the formula of Sabine.

Of course, in the laboratory any energy propagation other than that which goes directly through the dividing wall was excluded. The standard also defines the provisions for the background noise and for the correction of the measurements when the background is not lower than 15 dB compared to the levels measured in each frequency band. The measurement method used in the lab should respect the repeatability conditions in agreement with ISO 140-2. This process must be controlled and verified periodically.

ISO Part 4 Standard – On site measurements

The ISO 140 standard Part 4 “*Acoustics - Measurement of sound insulation in buildings and of building elements - Part 4: Field measurements of airborne sound insulation between rooms*” was issued in 1998.

The purpose of the standard is to establish the test procedures used for insulation of airborne sound of internal compartments, which are either walls or ceilings, in order to verify that the protection conditions desired are obtained and to identify possible construction faults.

For the on-site measurements the *standardized sound insulation* can be calculated using the following expression:

$$D_{nT} = L_1 - L_2 + 10 \log \frac{T_2}{0.5}$$

where L_1 and L_2 are the respective average sound pressure levels in the disturbing room and the receiving room, and T_2 is the reverberation time measured in the receiving room.

The standard also prescribes the measurement of the *normalized sound insulation* as defined by the expression:

$$D_n = L_1 - L_2 + 10 \log \frac{A_2}{A_0}$$

where A_2 is the equivalent absorption area of the receiving room (m^2) and A_0 is the reference area equal to $10 m^2$.

Appendix B of the standard reports the procedures for measuring the sound insulation in octave bands instead of thirds of an octave. For this purpose the range of frequencies considered starts from 125 Hz and goes up to 4000 Hz.

Appendix C of the standard reports the procedure to measure the lateral transmission, and these can be of fundamental importance in the on-site measurements.

A5.3 - MEASUREMENT OF THE TAPPING NOISE

Structural borne propagation is the propagation of sound energy from the emission environment, the waves being generated by collisions or vibrations, to the receiving environment via the solid structure of the building. Together with the measurement of the insulation from airborne noise, it permits classification of the buildings' acoustic insulation properties. The reference standards are **ISO 140-6** and **ISO 140-7**.

Instrumentation and measurement conditions

The measurement of the impact noise insulation is the sum of lab measurements and on site measurements. The specific properties of the construction materials used are measured in the laboratory, while the installation techniques and performances of the materials used in the construction are checked "on site". The necessary instrumentation to perform the measurements is composed of a standard impact sound source, measurement microphones of at least class 1 according to IEC 651 and IEC 804. The measurement equipment must be calibrated conforming to the IEC 942 standard. The frequency must be analyzed using 1/3 octave band filters according to IEC 1260. The frequency range must go from at least 100Hz to 5000Hz.

The standard sound source is described in Appendix A of ISO 140-6 and consists of a series of 5 hammers of 0.5 kg each falling from a height of 4 cm in a sequence of 10 impacts per second. Even though the effect on the floor and the sound level perceived in the lower floor are much higher than those usually associated with human steps, such levels are necessary to ensure that the signal/noise ratio is good and therefore to ensure that the results are reproducible.

Norma ISO Part 6 – Lab measurements

ISO 140 Part 6. "*Acoustics - Measurement of sound insulation in buildings and of building elements - Part 6: Laboratory measurements of impact sound insulation of floors*" was issued in 1998.

The purpose of this standard is to determine a laboratory measurement method for the transmission of the impact noise through the ceilings by using a standardized impact generator. The results obtained can be used to compare the insulating properties of the ceilings and to classify them accordingly.

Two types of test are prescribed: one for the complete ceiling and one for the floor to be installed on the standard ceiling.

In the first case the value of the standardized impact noise level L_n is calculated as defined by the expression:

$$L_n = L_2 + 10 \log \frac{A_2}{A_0}$$

where L_2 is the average sound pressure level measured in the receiving environment when the generator is functioning on the floor, A_2 is the equivalent absorption area of the same environment and A_0 is the reference equivalent absorption area, equal to 10 m².

For the floors, the measurement that describes their acoustic behaviour is the *attenuation of the impact noise* defined by the expression:

$$DL = L_{no} - L_n$$

where L_{no} is the standardized treading noise level measured when the generator is functioning on the standardized ceiling.

Norma ISO 140 Part 7 – On site measurements

ISO 140 Part 7. "Acoustics - Measurement of sound insulation in buildings and of building elements - Part 7: Field measurements of impact sound insulation of floors" was issued in 1998.

The on-site measurements are carried out on completed buildings and concern the entire ceiling. The measurement procedure is similar to that used in the laboratory and gives the value of the standardized treading noise level L_n (with lateral transmission) and the standardized treading level L_{nT} .

The normalized impact noise level L_n is calculated by using the same methods described for the laboratory.

The standardized impact level L_{nT} is calculated as follows:

$$L_{nT} = L_2 - 10 \log \frac{T_2}{T_0}$$

where T_2 is the reverberation time of the receiving environment and T_0 is the reference reverberation time equal to 0.5 s.

A6 - HDWME OUTDOOR PROTECTION – ASSEMBLY, DISASSEMBLY AND MAINTENANCE

Are given below operating instructions to disassembly, assembly and periodic maintenance of HDWME outdoor protection unit.

A6.1 - Disassembly

To completely disassemble the unit, a 1.5mm male hex key and a 14mm wrench are needed. To separate all components of the unit, proceed as follows; to extract the group-preamplifier microphone capsule to calibrate, start from step 3:

1. Remove the anti-bird spike by loosening the three hex head screws at the base of the windscreen.

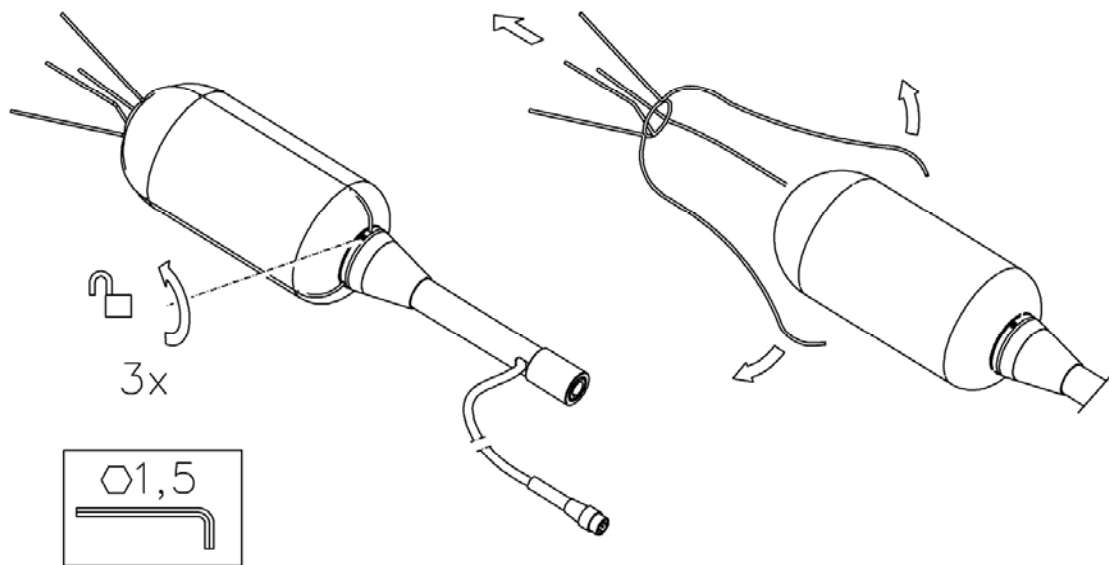

2. Pull up the windscreen HDSAV3 and the rain protection.

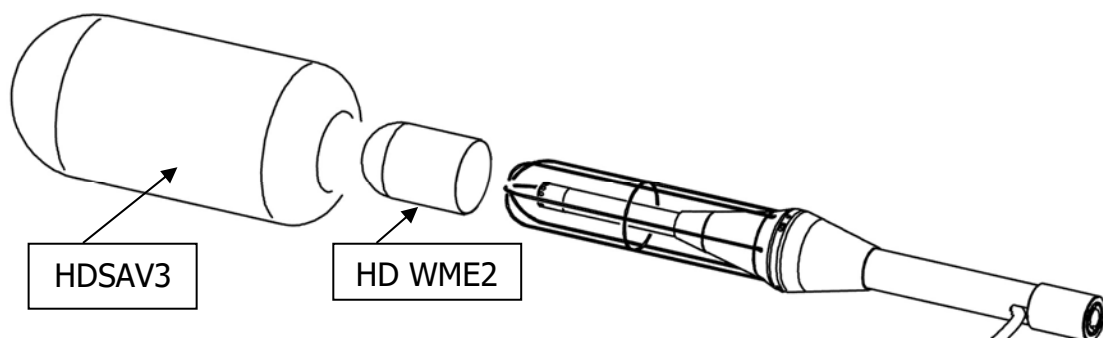

3. Unscrew the terminal placed at the lower end of the stern (A).

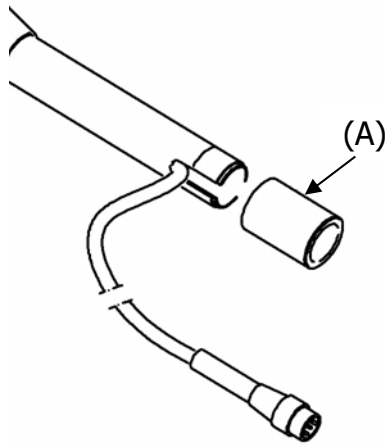

4. Unscrew the stern (B) and disconnect the cable connected to the preamplifier.

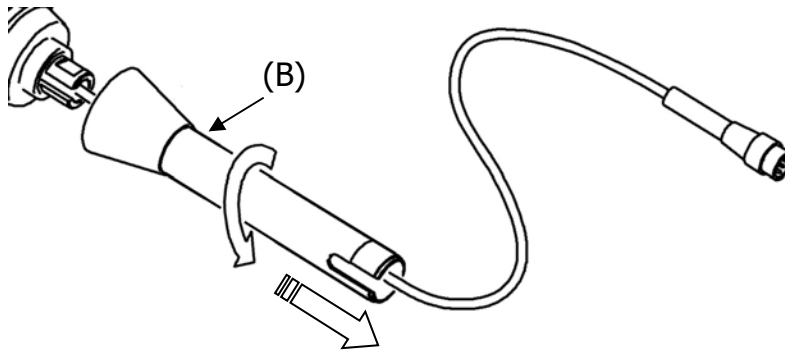

5. Unscrew the lock nut of the preamplifier (C) using, if required, a 14mm wrench. Be careful not to twist the preamplifier cable.

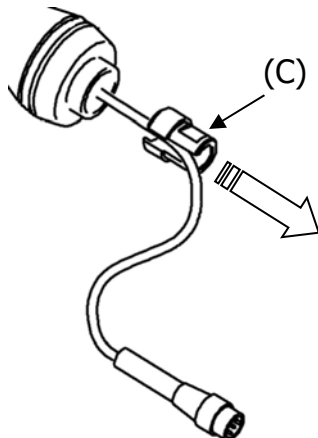

6. Remove the preamplifier (D) by pulling it slowly down. At this point the microphone is accessible and you can proceed with calibration.

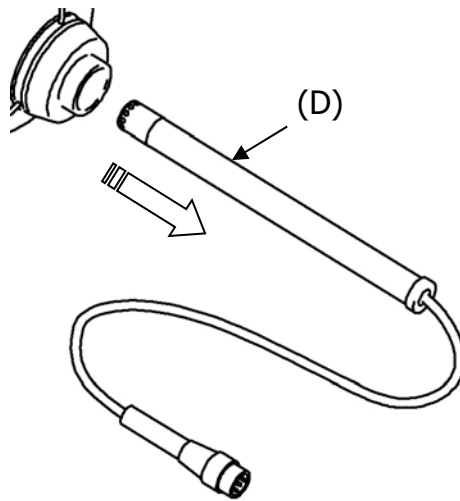

For details on calibration, see the specific chapter at page 47.

7. For assembly of HDWME protection, proceed as described in the next paragraph.

A6.2 - Assembly

To assemble the unit, a 1.5mm male hex key and a 14mm wrench are needed.

To assemble completely the protection, start from step 1. If you need only to assemble the preamplifier with the microphone after calibration, from step 4.

1. Fit the rain shield HDWME2 on the metal grid support.

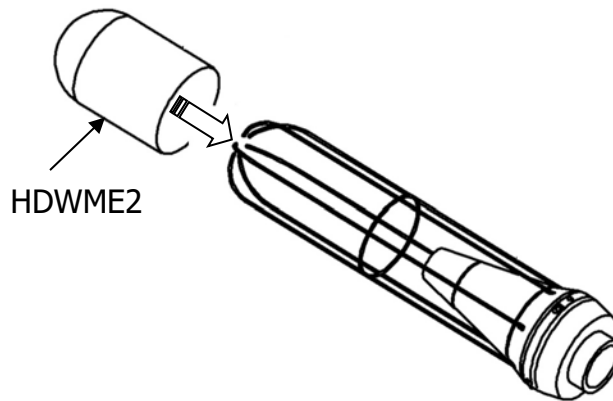

2. Insert the wind screen HD SAV3.

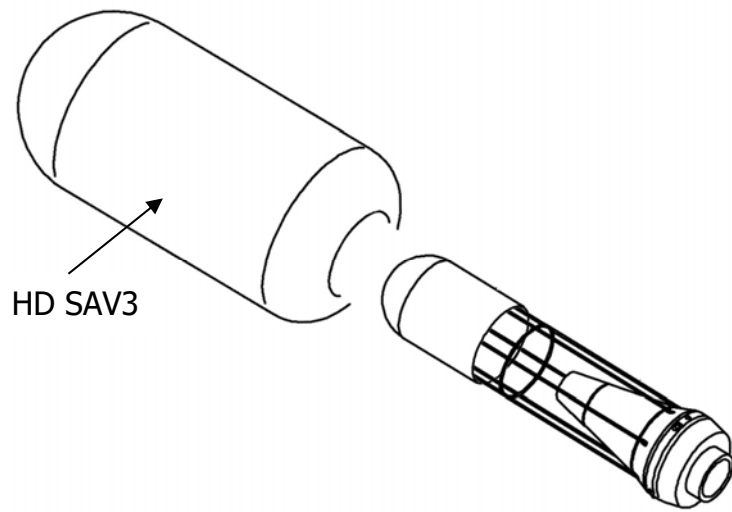

3. Apply the anti-bird spike and secure it using the three hex head screws located on the support at the base of the windscreen.

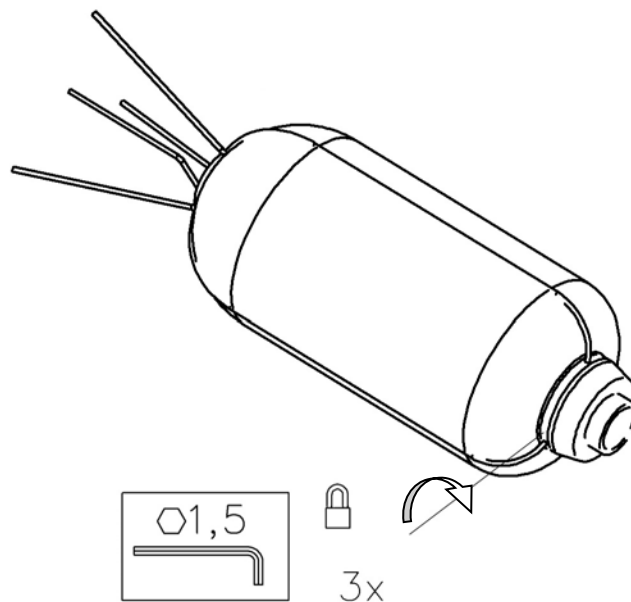

4. Insert the preamplifier (A) into the support pushing slowly upward until it's limit position.

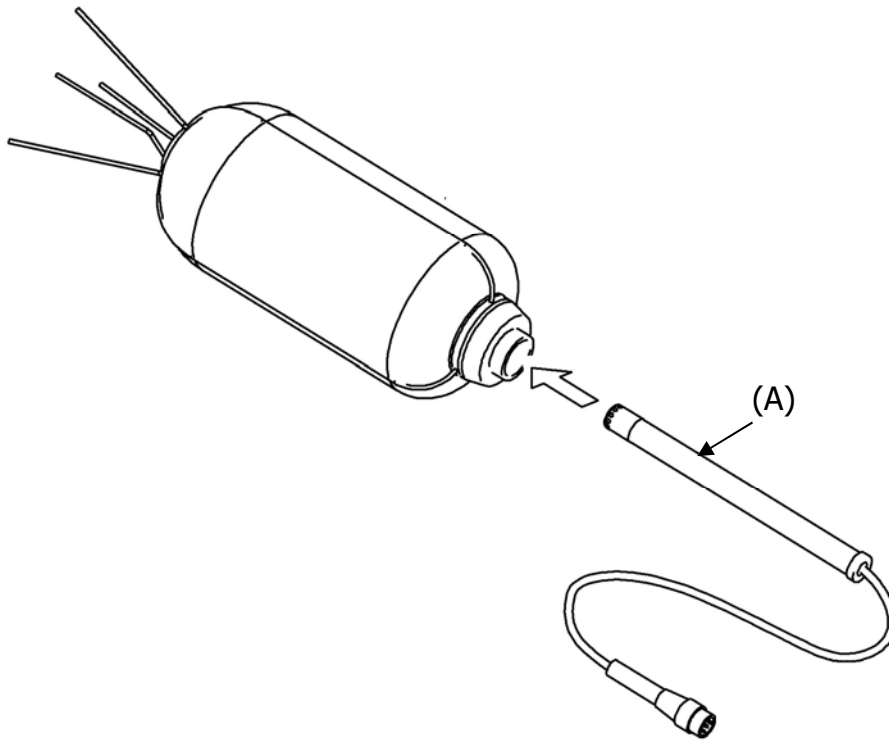

5. Screw the gland (B) using, if necessary, a 14mm wrench. Be careful not to twist the preamplifier cable.

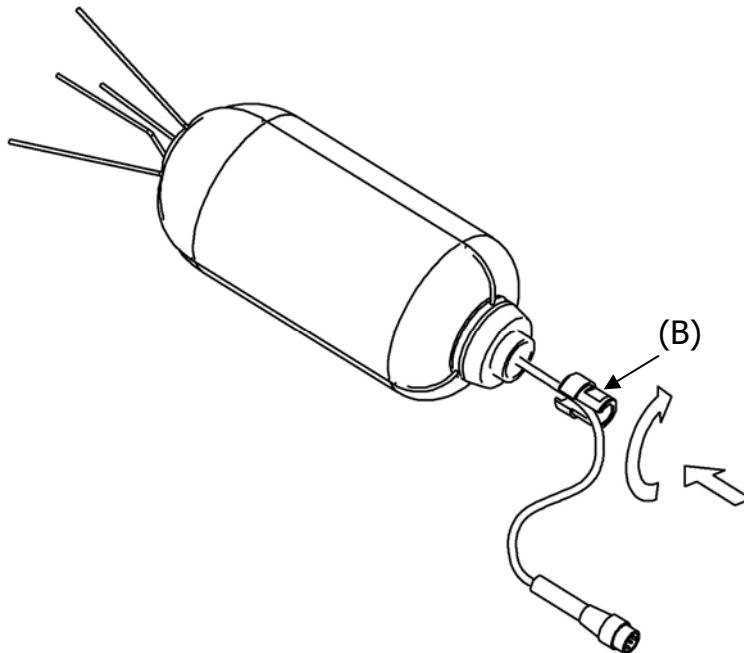

6. Insert the cable connected to the preamplifier through the system (C) and screw the stem to the support.

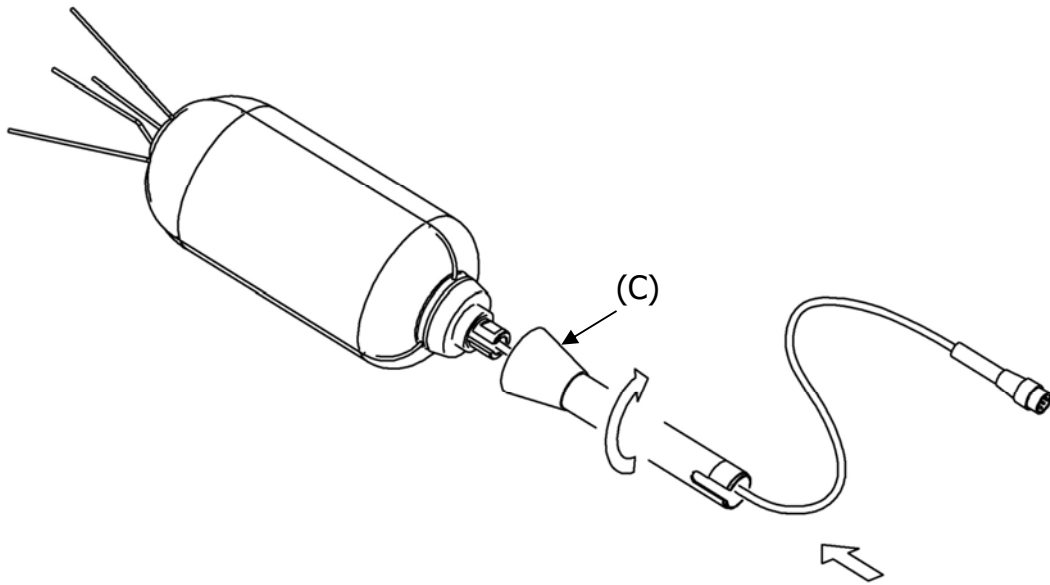

7. Screw the terminal placed at the lower end of the stem (D) releasing the cable laterally.

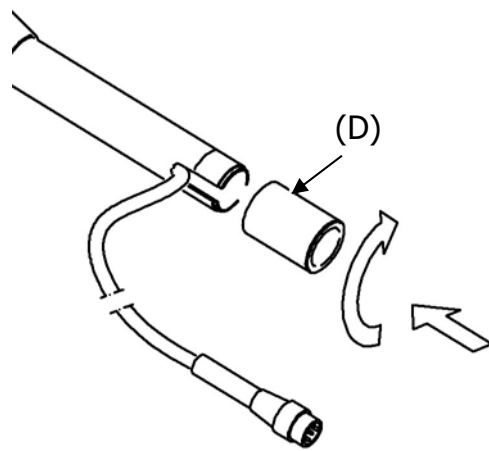

8. To secure the outdoor protection you can use the threaded end (D) or you can apply the fitting (E) on the tripod. The terminal (E) has two threads, 1/2 " and 1/4".

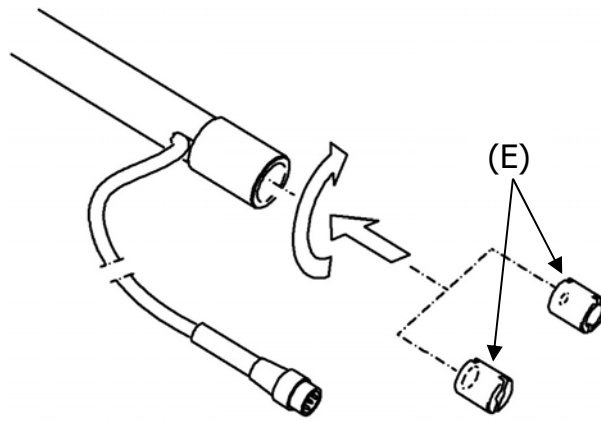

A7: DEFINITIONS

Frequency: is the number of oscillations per second, expressed in Hertz (Hz).

Wave Length: is the distance between two adjacent maximum values of pressure, expressed in meters (m).

Period: is the interval of time necessary to make a complete oscillation, expressed in seconds (s).

Sound Propagation Speed: is the distance covered by the sound wave front in the unit of time, expressed in meters/second (m/s). The propagation speed depends on the medium and, in the air, at ambient temperature, it equals to about 344 m/s.

Decibel: a decibel (symbol: dB) is defined by:

$$dB = 20 \cdot \log_{10} \frac{X}{X_0}$$

where: X is the measured quantity.

X₀ is the reference value of the measurement itself (to which correspond 0 dB).

Sound Pressure: the sound pressure is the value of the change of atmospheric pressure caused by acoustic perturbations, expressed in Pascal.

Reference Sound Pressure: sound pressure taken as reference for the calculation of the pressure level; it equals $20 \cdot 10^{-6}$ Pascal and corresponds to the average human audibility threshold at a frequency of 1 kHz.

Effective Value: sound pressure effective value (p_{rms}) is the value of constant pressure that is energetically equivalent to the instantaneous value (p) in a given time interval (T).

$$p_{rms} = \sqrt{\frac{1}{T} \int_{t_1}^{t_2} p^2(t) dt}$$

where: T = $t_2 - t_1$ is the considered time interval.

$p^2(t)$ is the sound pressure squared at time t in $t_1 \div t_2$ interval.

rms means “ROOT MEAN SQUARE”, that is square root of the average of squared values.

Sound pressure effective value is expressed in Pa and takes importance in sound measurement since the value is directly connected to the quantity of energy contained in the sound signal.

Crest Factor: is the ratio between the maximum and the effective value of a quantity, measured in a given time interval with reference to the arithmetic average value.

Sound Pressure Level: is defined by the expression:

$$L_p = 20 \cdot \log_{10} \frac{p_{rms}}{p_0}$$

where: p_{rms} = pressure effective value.

p_0 = reference sound pressure.

L_p sound pressure level (also referred to as SPL) is expressed in dB.

Sound Pressure Level with Frequency Weighting: The sound pressure level can be weighted in frequency applying a filter that changes in a predetermined way the signal spectral structure. Acoustic standard filters are referred to as A and C.

Sound Pressure Level with Time Weighting: The sound pressure level can be exponentially weighted over the time with a given time constant. It is defined by the expression:

$$L_{Yp} = 10 \cdot \log_{10} \left(\frac{1}{\tau} \int_{-\infty}^t \frac{p^2(\xi) \cdot e^{-\frac{t-\xi}{\tau}}}{p_0^2} d\xi \right)$$

where: τ = time constant expressed in seconds.
 Y = symbol associated to the applied time constant.
 ξ = fictitious variable for the integration over elapsed time up to t measurement instant.
 $p^2(\xi)$ = the instantaneous squared pressure.
 p_0^2 = the square of reference pressure.

The sound pressure level can be weighted over the time with two standard time constants: FAST (F) and SLOW (S), corresponding to 0.125s and 1s, respectively. A third time weighting called IMPULSE (I) has been defined for the identification of impulsive components, presenting a time constant for increasing levels equal to 35ms, while for decreasing levels it equals 1.5s.

The sound pressure level can be weighted both in frequency and in time. For example, L_{AFp} will indicate a frequency weighted level with A filter and with FAST time constant.

Sound Pressure Peak Level: referred to as L_{pk} , it equals the absolute value of the maximum sound pressure in a given time interval, expressed in decibel. Sound pressure peak level can be frequency weighted.

Continuous Equivalent Sound Pressure Level: referred to as L_{eq} , it is defined over a T time interval as:

$$L_{eq,T} = 10 \cdot \log_{10} \left(\frac{1}{T} \int_{t-T}^t \frac{p^2(\xi)}{p_0^2} d\xi \right)$$

where: $T = t_2 - t_1$ is the time interval under examination.
 ξ = fictitious variable for the integration over elapsed time up to t measurement instant.
 $p^2(\xi)$ = the instantaneous squared pressure.
 p_0^2 = the square of reference pressure.

The equivalent sound pressure level can be frequency weighted. For example, $L_{Aeq,T}$ will give the equivalent sound pressure level over T interval, frequency weighted with A filter.

Total L_{eq} calculated by measuring partial L_{eq}

If you need to get the total L_{eq} after measuring partial L_{eq} , you can use the formula:

$$L_{eq} = 10 \cdot \log_{10} \sum_1^n \frac{T_i}{T} \cdot 10^{\frac{L_{eq,i}}{10}}$$

where $T = \sum_i^n T_i$

Example:

Let's suppose we measured:

$L_{eq,1} = 80$ dB over 1 h.

$L_{eq,2} = 90$ dB over 2 h.

$L_{eq,3} = 50$ dB over 5 h.

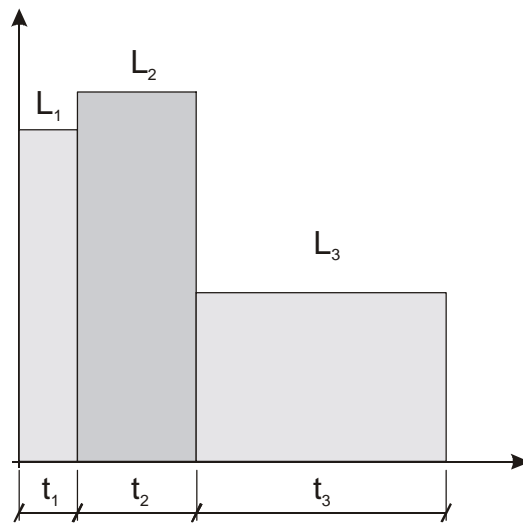

$$L_{eq,T} = 10 \cdot \log_{10} \left[\frac{T_1 \cdot 10^{\frac{L_{eq,1}}{10}} + T_2 \cdot 10^{\frac{L_{eq,2}}{10}} + T_3 \cdot 10^{\frac{L_{eq,3}}{10}}}{T_1 + T_2 + T_3} \right]$$

$L_{eq,1}, L_{eq,2}, L_{eq,3}$ partial equivalent levels.

T_1, T_2, T_3 integration times of partial equivalent levels.

$L_{eq,T}$ total equivalent level.

In the example: $T = 1 \text{ h} + 2 \text{ h} + 5 \text{ h} = 8 \text{ h}$.

The result is:

$$L_{eq,T} = 10 \cdot \log_{10} \left[\frac{1 \cdot 10^8 + 2 \cdot 10^9 + 5 \cdot 10^5}{8} \right] = 84.2 \text{ dB}$$

Sound Exposure Level: represented by the L_E symbol (or SEL), it is defined over a given $t_1 \div t_2$ time interval like:

$$L_{E,T} = 10 \cdot \log_{10} \left(\int_{t_1}^{t_2} \frac{p^2(t)}{p_0^2 \cdot T} dt \right) = L_{eq,T} + 10 \cdot \log_{10} \frac{T}{T_0}$$

where: $T = t_2 - t_1$ is the time interval under examination.
 $p^2(t)$ = the square of instantaneous pressure.
 p_0^2 = the square of reference pressure.
 $L_{eq,T}$ = continuous equivalent sound pressure level over “T” interval
 $T_0 = 1s$.

The level of L_E sound exposure is expressed in decibel and can be frequency weighted. For example, L_{AE} will indicate the level of frequency weighted sound exposure with A filter.

Dose

In the field of environmental noise monitoring, preventing auditory injuries, the measurement of the noise “Dose” is used. It is meant as a percentage fraction of a daily maximum exposure to noise:

$$D(Q) = \frac{100}{T_c} \cdot \int_0^T 10^{\frac{L-L_c}{q}} dt$$

$D(Q)$ = exposure percentage for an Exchange Rate equal to Q.
 T_c = daily exposure time (usually 8 hours).
 T = measurement time.
 L = sound pressure level when it is higher than the Threshold Level, and $-\infty$ otherwise.
 L_c = Criterion Level for a daily exposure corresponding to 100% of the dose.
 Q = Exchange Rate.
 q = parameter independent of the exchange rate and equal to:

- 10 for $Q = 3$ dB
- $5/\log 2$ for $Q = 5$ dB
- $4/\log 2$ for $Q = 4$ dB

**DICHIARAZIONE DI CONFORMITÀ UE**
EU DECLARATION OF CONFORMITY**Delta Ohm S.r.L. a socio unico – Via Marconi 5 – 35030 Caselle di Selvazzano – Padova – ITALY**Documento Nr. / Mese.Anno: **5099 / 07.2019**
Document-No. / Month.Year :

Si dichiara con la presente, in qualità di produttore e sotto la propria responsabilità esclusiva, che i seguenti prodotti sono conformi ai requisiti di protezione definiti nelle direttive del Consiglio Europeo:

*We declare as manufacturer herewith under our sole responsibility that the following products are in compliance with the protection requirements defined in the European Council directives:*Codice prodotto: **HD2010UC/A**
Product identifier :Descrizione prodotto: **Fonometro**
Product description : **Sound level meter**I prodotti sono conformi alle seguenti Direttive Europee:
The products conform to following European Directives:

Direttive / Directives	
2014/30/EU	Direttiva EMC / EMC Directive
2014/35/EU	Direttiva bassa tensione / Low Voltage Directive
2011/65/EU - 2015/863/EU	RoHS / RoHS

Norme armonizzate applicate o riferimento a specifiche tecniche:
Applied harmonized standards or mentioned technical specifications:

Norme armonizzate / Harmonized standards	
EN 61010-1:2010	Requisiti di sicurezza elettrica / Electrical safety requirements
EN 61326-1:2013	Requisiti EMC / EMC requirements
EN 50581:2012	RoHS / RoHS

Il produttore è responsabile per la dichiarazione rilasciata da:
The manufacturer is responsible for the declaration released by:

Johannes Overhues

Amministratore delegato
Chief Executive Officer

Caselle di Selvazzano, 19/07/2019

Questa dichiarazione certifica l'accordo con la legislazione armonizzata menzionata, non costituisce tuttavia garanzia delle caratteristiche.

This declaration certifies the agreement with the harmonization legislation mentioned, contained however no warranty of characteristics.

GUARANTEE



Member of GHM GROUP

TERMS OF GUARANTEE

All DELTA OHM instruments are subject to accurate testing, and are guaranteed for 24 months from the date of purchase. DELTA OHM will repair or replace free of charge the parts that, within the warranty period, shall be deemed non efficient according to its own judgement. Complete replacement is excluded and no damage claims are accepted. The DELTA OHM guarantee only covers instrument repair. The guarantee is void in case of incidental breakage during transport, negligence, misuse, connection to a different voltage than that required for the appliance by the operator. Finally, a product repaired or tampered by unauthorized third parties is excluded from the guarantee. The instrument shall be returned FREE OF SHIPMENT CHARGES to your dealer. The jurisdiction of Padua applies in any dispute.



The electrical and electronic equipment marked with this symbol cannot be disposed of in public landfills. According to the Directive 2011/65/EU, the european users of electrical and electronic equipment can return it to the dealer or manufacturer upon purchase of a new one. The illegal disposal of electrical and electronic equipment is punished with an administrative fine.

This guarantee must be sent together with the instrument to our service centre.

IMPORTANT: Guarantee is valid only if coupon has been correctly filled in all details.

Instrument Code: **HD2010UC/A**

Serial Number _____

RENEWALS

Date _____

Date _____

Inspector _____

Inspector _____

Date _____

Date _____

Inspector _____

Inspector _____

Date _____

Date _____

Inspector _____

Inspector _____



The quality level of our instruments is the result of the constant development of the product. This may produce some differences between the information written in this manual and the instrument you have purchased. We cannot completely exclude the possibility of errors in the manual, for which we apologize.

The data, images and descriptions included in this manual cannot be legally asserted. We reserve the right to make changes and corrections with no prior notice.

