

Operating manual

LoRaWAN® Data Loggers

LR35... series



Companies / Brands of GHM

Members of GHM GROUP:

GREISINGER
HONSBURG
Martens
IMTRON
Delta OHM
VAL.CO

www.deltaohm.com

Keep for future reference.

TABLE OF CONTENTS

| | | |
|-----------|---|-----------|
| 1 | INTRODUCTION | 3 |
| 2 | DATA LOGGERS DESCRIPTION | 5 |
| 3 | INSTALLATION AND CONFIGURATION | 8 |
| 3.1 | CONNECTION OF THE BATTERY | 8 |
| 3.2 | DATA LOGGER CONFIGURATION | 8 |
| 3.3 | FIXING THE DATA LOGGER | 8 |
| 3.4 | M12 CONNECTORS PIN-OUT | 10 |
| 3.5 | INPUTS IN THE INDOOR MODEL LR35[G]H | 11 |
| 3.6 | INPUTS IN THE OUTDOOR MODEL LR35[L]WH | 13 |
| 3.7 | CONNECTIONS IN THE OUTDOOR MODEL LR35[L]W -MB | 14 |
| 3.8 | HP712 LEVEL SENSOR CONNECTION (FOR LR35[L]WDPTC) | 15 |
| 4 | CONNECTION TO THE NETWORK | 16 |
| 4.1 | NETWORK CONNECTION / DISCONNECTION | 16 |
| 4.2 | GATEWAY | 16 |
| 4.3 | WEB APPLICATION..... | 16 |
| 5 | DATA LOGGERS WITH LCD OPTION | 17 |
| 5.1 | MAXIMUM, MINIMUM AND AVERAGE OF THE MEASUREMENTS (ONLY INDOOR MODELS) | 18 |
| 5.2 | MENU (ONLY INDOOR MODELS) | 18 |
| 5.2.1 | THE MENU IN DATA LOGGERS WITH GRAPHIC LCD | 18 |
| 5.2.2 | THE MENU IN DATA LOGGERS WITH CUSTOM LCD | 23 |
| 6 | CALIBRATION | 27 |
| 6.1 | CO ₂ CALIBRATION | 27 |
| 6.1.1 | CO ₂ SENSOR AUTO-CALIBRATION | 28 |
| 6.2 | DIFFERENTIAL PRESSURE CALIBRATION | 29 |
| 6.3 | RELATIVE HUMIDITY CALIBRATION | 29 |
| 7 | TECHNICAL CHARACTERISTICS | 31 |
| 8 | STORAGE OF INSTRUMENTS | 39 |
| 9 | SAFETY INSTRUCTIONS | 39 |
| 10 | PROBES AND ACCESSORIES ORDERING CODES | 40 |

1 INTRODUCTION

The data loggers of the **LR35...** series are wireless devices for **IoT** (Internet of Things) applications that use **LoRaWAN®** technology for long distance data transmission.

LoRaWAN® technology uses the unlicensed frequencies of the ISM band (for example EU868, US915, AU915, KR920, AS923, IN865) and allows a transmission range of several kilometers depending on the installation position and the urbanization condition of the place where the network infrastructure is located, with extremely limited energy consumption, allowing long operation of battery-powered devices.

A system based on LoRaWAN® technology consists of 4 stages:

A. Sensors / data loggers

They detect the physical quantities at the measuring points and send the data via RF to one or more gateways (access points) of the LoRaWAN® network.

The data loggers of the LR35 series can be integrated into any public or private LoRaWAN® network, even existing ones.

B. LoRaWAN® gateway (access point)

The gateway receives the data via RF from the sensors / data loggers and forwards them, using a TCP/IP connection via cellular (e.g. LTE) or ETHERNET/Wi-Fi network, to a network server.

Multiple gateways can be used in the system to increase RF coverage. The gateways are not associated with particular sensors but forward the data of all active sensors in their coverage area.

Delta OHM can provide already configured third-party gateways, or the user can use his own gateway and do the configuration himself.

C. Network server

It is the IoT platform that receives the data from the sensors / data loggers and forwarded by the gateway. The data loggers of the LR35 series are preconfigured to send the data to the free-to-use network server "**The Things Network (TTN)**", but the user can change the configuration to use other servers, for example a possible network server embedded into the gateway, or Cloud-based platforms.

D. Web application

It is the application that allows you to view the data on the network server.

It can be the Delta OHM Cloud or a third-party service, both for free use (e.g. myDevices) and for a fee (e.g. ioThink®).

If the Delta OHM Cloud is used, an IoT platform managed by Delta OHM automatically and transparently and free of charge for the user converts the data present on the network server (The Things Network) into the data format required by the Delta OHM Cloud. The Delta OHM IoT platform also allows sending data via **FTP**.

If instead a third-party service is used, the data are available with the standard **Cayenne LPP** data protocol (only for the most common environmental quantities, such as temperature, relative humidity, barometric pressure, illuminance, ...) or with a **proprietary data protocol provided free of charge** which allows you to manage any type of measurement and the development of advanced customized applications.

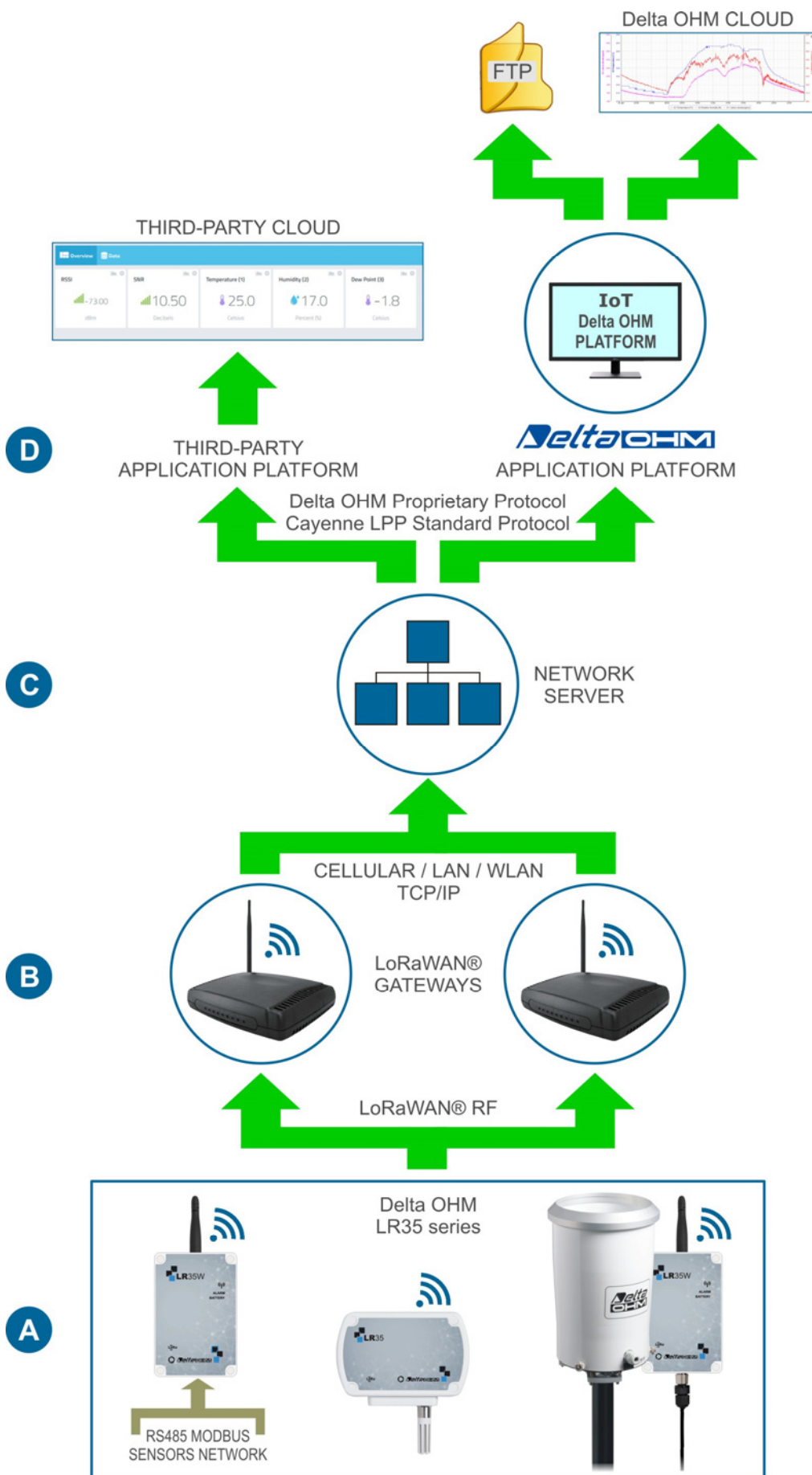
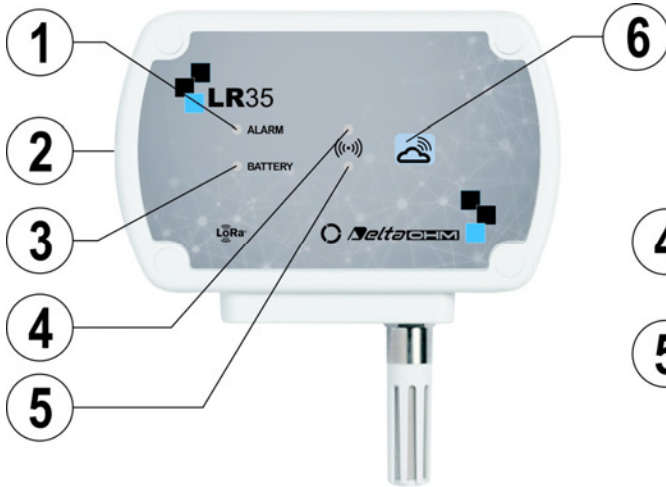

Fig. 1.1: LoRaWAN® network architecture

2 DATA LOGGERS DESCRIPTION

INDOOR MODELS



Models without display



Models with LCD display

OUTDOOR MODELS

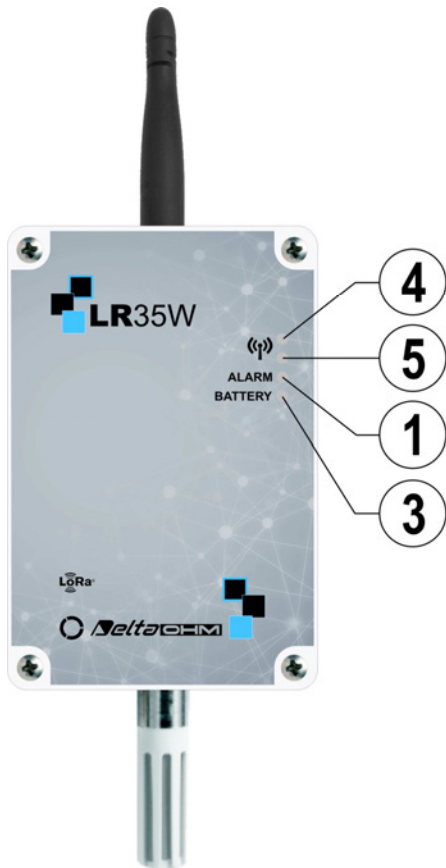

Models without display



Models with LCD display

1. ALARM LED: red color; it blinks when a measurement is in alarm condition.
2. USB port with mini-USB connector. In the outdoor models, the USB port is internal.
3. BATTERY LED: green color, it indicates the internal battery charge level. As the battery is running low, the LED blinks with a lower frequency (once every 5 s =

battery is charged, once every 10 s = 50% battery charge, once every 15 s = battery is almost discharged).

4. Red RF LED: it blinks to signal that data transmission has failed.
5. Green RF LED: it blinks when the data transmission has been successful.
6. Button for connection to the LoRaWAN® network.
7. MENU/ENTER key: allows access to the configuration menu; confirm the selected option or the set value in the menu.
8. ▲ key: in normal operation, it scrolls the quantities measured by the data logger; it scrolls upwards the available options or decreases the set value in the menu.
9. FUNC/▼ key: in normal operation, it displays the maximum (MAX), the minimum (MIN) and the average (AVG) of the measurements; it scrolls downwards the available options or decreases the set value in the menu.
10. LCD Display.
For the indoor models, the type of display, custom or graphic, depends on the model. For the outdoor models, the display is always custom.
11. RF antenna.
In LR35W[B]PM and in the indoor models, the antenna is internal.

The green and red RF LEDs blink simultaneously if the device is in error condition.

TYPE OF SENSORS / CONNECTIONS

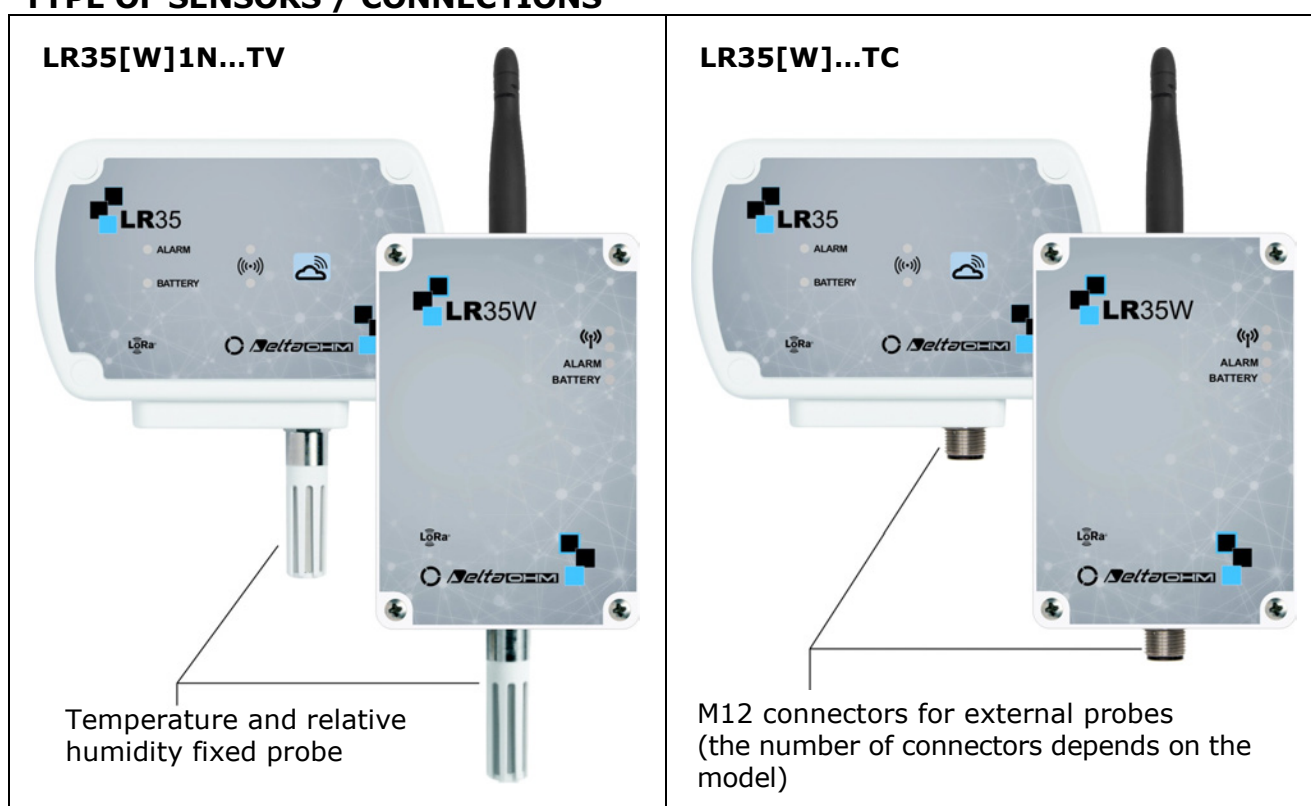

LR354r1Z



Differential pressure inputs for Ø 5 mm flexible hose

LR351NB



Temperature, relative humidity and CO₂ integrated sensors

LR35H



Protective cover of the terminal inputs for standard analog sensors

LR35WDPTC



M12 connector for rain gauge

Cable gland for level probe

**LR35WH
LR35W-MB**

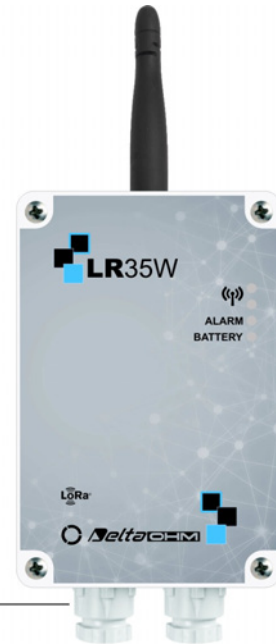

Cable glands

3 INSTALLATION AND CONFIGURATION

3.1 CONNECTION OF THE BATTERY

For shipments by aircraft, the battery of the device must be disconnected.

Open the instrument by unscrewing the 4 front screws, then connect the battery female connector to the male connector indicated with **BATT** on the electronic board, paying attention to the correct polarity: the connector is equipped with a polarization key that prevents the possibility of a wrong insertion of the connector.

The indoor models can be closed by fixing the 4 front screws. The outdoor models, instead, must be closed after the configuration, in order to keep the internal USB port accessible.

Note: the models LR35W[B]PM and LR35[L]W-MB have no internal battery, but require 7...30 Vdc external power supply. For the connection of these models, see the following paragraphs.

3.2 DATA LOGGER CONFIGURATION

The data logger is already factory configured to send data to **TTN** network server. As soon as the data logger is powered, it automatically connects to the **TTN** server (if a LoRaWAN® gateway is present within the data logger coverage range), performs the time synchronization and starts sending data.

If you want to change the data logger settings, proceed as follows:

1. Download the HD35AP-S software from the Delta OHM website (www.deltaohm.com) and install it on the PC.

2. Connect the USB port of the data logger to the PC through the **CP23** cable.

Note: the USB connection does not require the installation of drivers: when the data logger is connected to the PC, the Windows® operating system uses drivers already included in the operating system.

Note: the instrument consumption increases strongly when the USB port is connected to the PC; in order to extend the battery life, it is recommended to connect the data logger to the PC only for the time strictly necessary.

3. Start the HD35AP-S software, perform the connection procedure selecting the type of connection "Serial connection (HID)" and perform the settings:

- To change the LoRaWAN® network settings, select the "Instruments setup" > "LoRa Options" menu.
- To set the measuring and data sending intervals, the alarms, the inputs (if configurable), press the button "Settings" with the data logger serial number.
- To set the clock, select the "Instruments setup" > "Setting of date and time" menu.

See the software on-line help for the usage details and other features available in the software.

In the indoor models with display, the configuration can also be changed via the front keyboard (see paragraph 5.2).

3.3 FIXING THE DATA LOGGER

The installation of the indoor models is on the wall using the removable support provided or, alternatively, using the optional HD35.11K kit for fixed installation with

safety lock.

The outdoor models can be wall mounted using the HD35.24W optional flange or installed on a mast using the HD35.24C optional flange. The data loggers supplied with solar shield are already prepared for fixing to a mast.

If the data logger requires external probes, connect them to the inputs at the bottom of the instrument. If the data logger has several inputs, respect the indications reported near the inputs (type of probe, channel number, polarity for differential pressure).



Fig. 3.3.1: indoor models installation modes

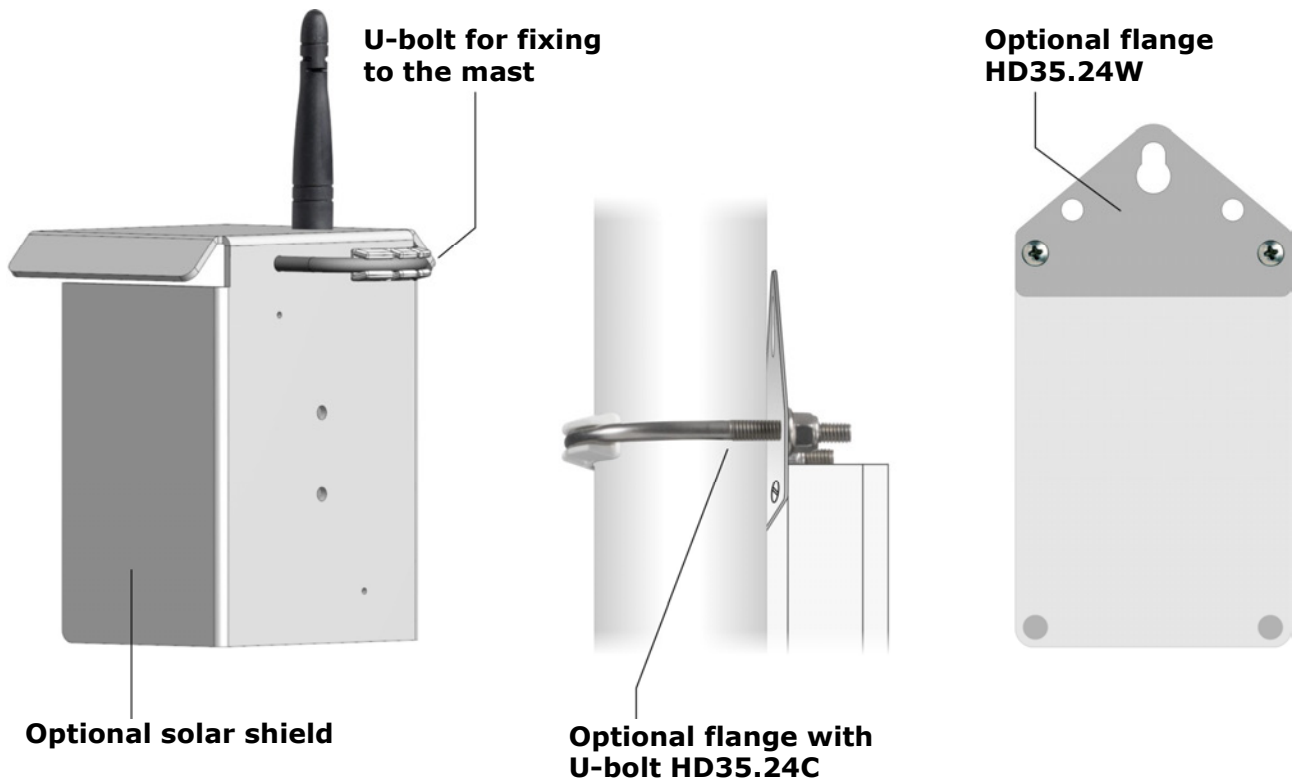
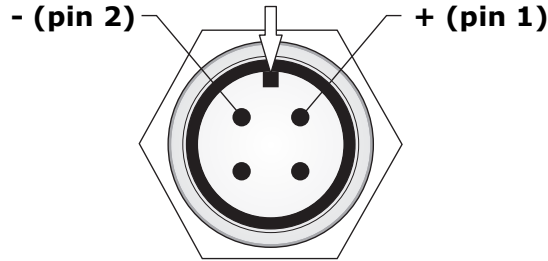

Fig. 3.3.2: outdoor models installation modes

3.4 M12 CONNECTORS PIN-OUT

The following figures show the external side of the data logger M12 connector. The arrow indicates the connector reference notch.

Connector for rain gauges and pyranometers:



Connector for HP3510... probes:

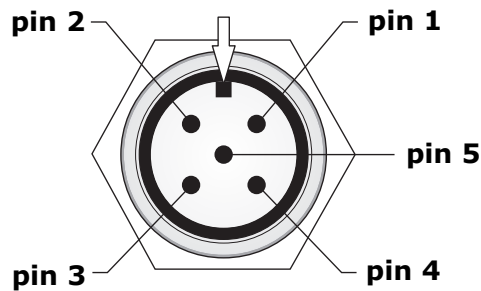

| M12 connector pin | Description |
|-------------------|--|
| 1 | Upper surface output positive (HP3501...) %VWC output positive (HP3510...) |
| 2 | Not connected |
| 3 | GND |
| 4 | Lower surface output positive (HP3501...) Temperature output positive (HP3510...) |
| 5 | Power supply positive |

Connector for temperature probes:

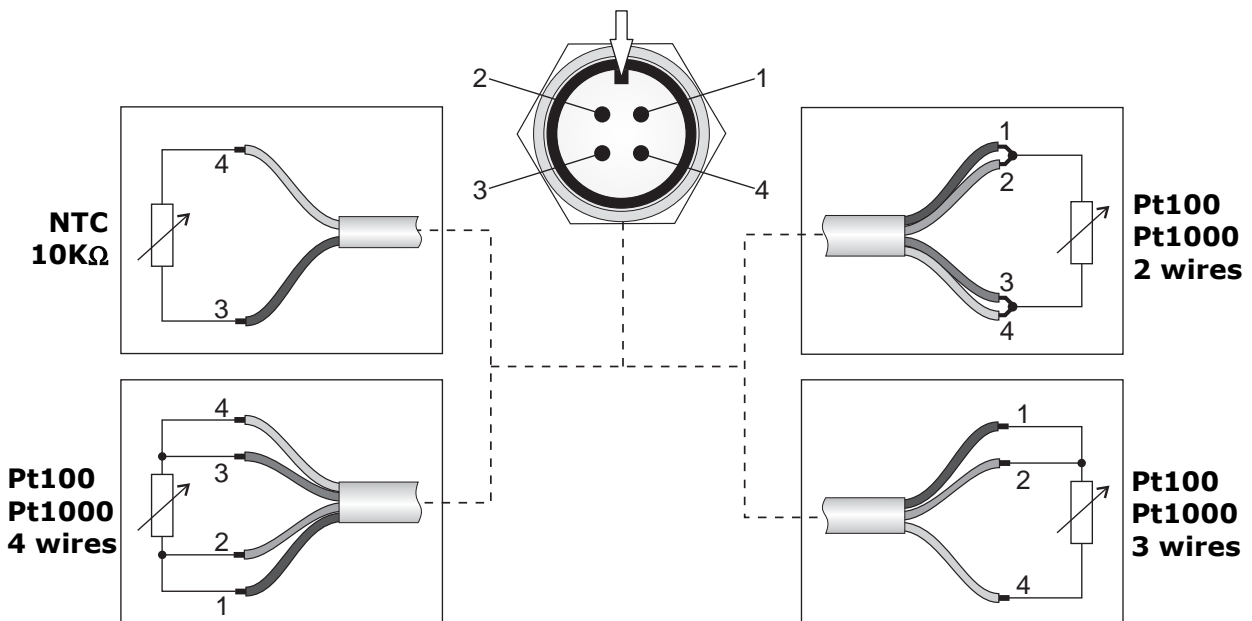

3.5 INPUTS IN THE INDOOR MODEL LR35[G]H

LR35[G]H has three terminal header inputs. Each input can be configured as a Pt100/Pt1000, thermocouple, 0/4...20 mA (shunt resistance is inside), 0...50 mV, 0...1 V or potentiometric input. Only input 3 can be also configured as pulse counter (count of voltage-free contact switchings).

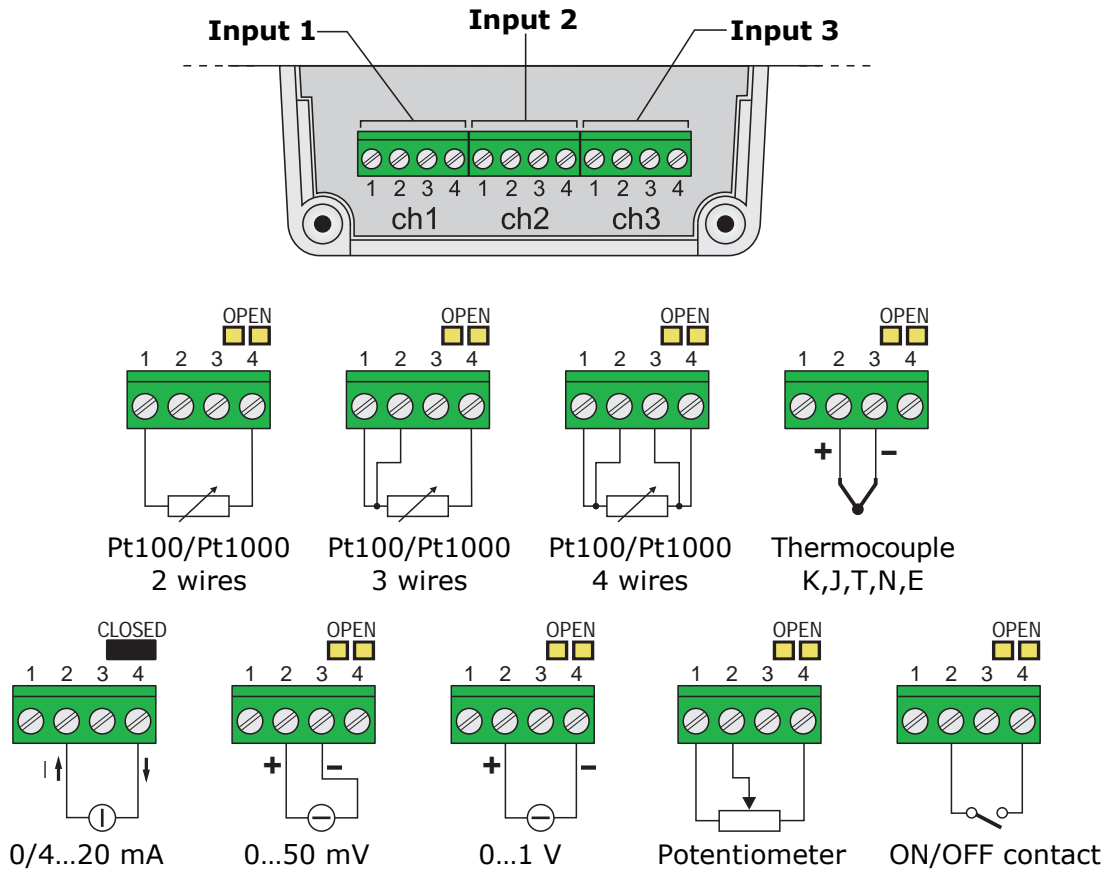

Fig. 3.5.1: sensors connection in LR35[G]H

If a channel is configured as current input, insert the 50 Ω shunt resistance closing the jumper placed above the terminals of the relevant channel. In all the other configurations, leave the jumper open. The current input accepts any value in the range 0...20 mA.

Inputs configuration

Configuration of inputs can be implemented through the HD35AP-S software (see software instructions) or, if the data logger is equipped with a display, through the front keyboard.

To configure the input channel ch x ($x=1,2,3$ is the number of the input) through the keyboard, access the menu and select the item *Ch x settings* \Rightarrow *ch x configuration*. Set the type of input among those available:

- Pt100 2-wire, Pt100 3-wire, Pt100 4-wire, Pt1000 2-wire, Pt1000 3-wire, Pt1000 4-wire,
- TC-K, TC-J, TC-T, TC-N, TC-E,
- 0-1V, 0-50mV, 4-20mA, Potentiometer, Counter, Frequency,
- 0-1V Mapped, 0-50mV Mapped, 4-20mA Mapped, Mapped Potent., Mapped Count., Mapped Freq.

The input types *4-20mA* and *4-20mA Mapped* also work with 0-20 mA signals. The input types *Counter* and *Frequency* are only in channel Ch 3.

Set *NO MEASURE* if the channel is not used.

The indication *Mapped* means that a linear correspondence between input values (in mA, mV, V, Ω or counts) and the values of a physical quantity will be associated to the channel. For example, if *4-20mA* is selected, the data logger stores the input value in mA; if *4-20mA Mapped* is selected, the data logger doesn't store the input value in mA but the corresponding value of the physical quantity associated to the input.

By selecting a Mapped-type configuration, the guided procedure for the association between the input values (in mA, mV, V, Ω or counts) and the values of the corresponding physical quantity is started. The procedure is illustrated below:

1. After confirming the selection of a Mapped input, the procedure start message is displayed, press **ENTER** to continue.
2. Select the measurement unit of the physical quantity among those proposed by the instrument. If the desired measurement unit is not in the list, select *NOT DEF* (not defined). Select the option OK and confirm with **ENTER** to continue.
3. Select the measurement resolution of the physical quantity among those proposed by the instrument. Select the option OK and confirm with **ENTER** to continue.
4. A message will be displayed reminding that the two coordinates of the linear relation between input and physical quantity will be now required:
 - x_1 =input value (in mA, mV, V, Ω or counts) in the first point,
 - y_1 =value of the physical quantity corresponding to the input value x_1 ,
 - x_2 =input value (in mA, mV, V, Ω or counts) in the second point,
 - y_2 =value of the physical quantity corresponding to the input value x_2 ,

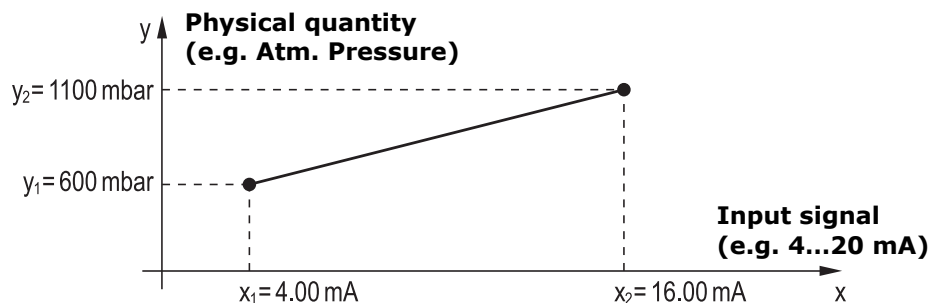

Fig. 3.5.2: association of a physical quantity to the input signal

press **ENTER** to continue.

5. Select the input value x_1 for the first point (e.g. 4.00 mA). Select the option OK and confirm with **ENTER** to continue.
6. Select the physical quantity value y_1 for the first point (e.g. 600 mbar). Select the option OK and confirm with **ENTER** to continue.
7. Select the input value x_2 for the second point (e.g. 20.00 mA). Select the option OK and confirm with **ENTER** to continue.
8. Select the physical quantity value y_2 for the second point (e.g. 1100 mbar). Select the option OK and confirm with **ENTER** to continue.
9. The message requesting confirmation of the configuration storage is displayed, press **YES** to save the settings and terminate the procedure.

The procedure can be stopped at any moment by selecting the option CANCEL and confirming with **ENTER**.

A user name can be associated to each measurement channel to remind the type of physical quantity detected. The user name can be set only through the HD35AP-S software.

3.6 INPUTS IN THE OUTDOOR MODEL LR35[L]WH

LR35[L]WH has four terminal header inputs. Each input can be configured as a Pt100/Pt1000, thermocouple, 0/4...20 mA (shunt resistance is inside), 0...50 mV, -50...50 mV, 0...1 V, 0...10 V or potentiometric input. Only input 4 can be also configured as pulse counter (count of voltage-free contact switchings).

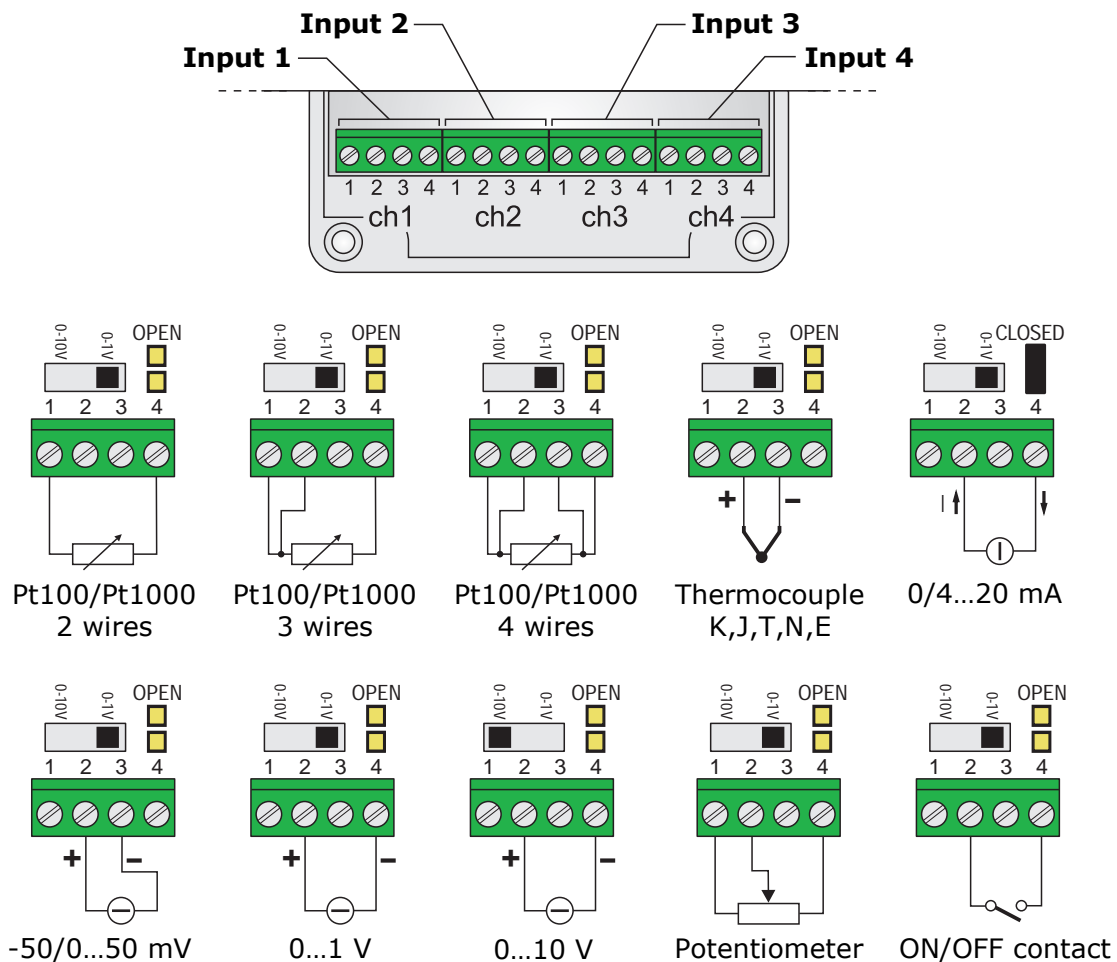

Fig. 3.6.1: sensor connection in LR35[L]WH

If a channel is configured as 0-10 V input, set the switch above the terminals of the channel to 0-10V. In all other cases, set the switch to 0-1V.

If a channel is configured as current input, insert the 50 Ω shunt resistance closing the jumper placed above the terminals of the relevant channel. In all the other configurations, leave the jumper open. The current input accepts any value in the range 0 to 20 mA.

Configuration of inputs is done with the HD35AP-S software (see software instructions).

3.7 CONNECTIONS IN THE OUTDOOR MODEL LR35[L]W -MB

LR35[L]W-MB has:

- 7...30 Vdc power supply input (terminals 1, 2).
- Switched power supply output (terminals 3, 4). It has the same value as the power supply input, but it is **active only during the measurement acquisition phase**. The output can be used to power the sensors.
- RS485 port (terminals 5, 6, 7) with Modbus-RTU protocol for the connection of the sensors.
- Potential-free contact input (terminals 8, 9). For example, a rain gauge with contact output can be connected.

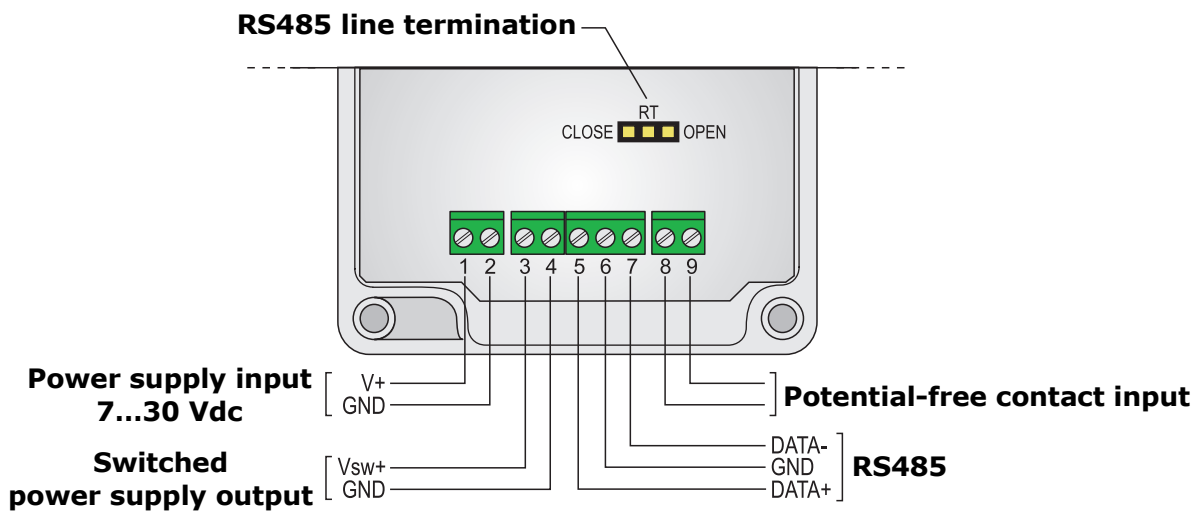

Fig. 3.7.1: LR35[L]W-MB connections

The jumper placed above the terminals allows inserting the termination resistance for long distance RS485 connection. Place the jumper between the **RT** and **CLOSE** indications to connect the termination resistance. Place the short jumper between the **RT** and **OPEN** indications to disconnect the resistance.

3.8 HP712 LEVEL SENSOR CONNECTION (FOR LR35[L]WDPTC)

| Terminal | Description | sensor wire color (*) |
|----------|------------------------------|-----------------------|
| 9 | GND | White |
| 10 | Sensor output positive | Green |
| 12 | Sensor power supply positive | Brown |

(*) The colors may be subject to change: always check the sensor data sheet.

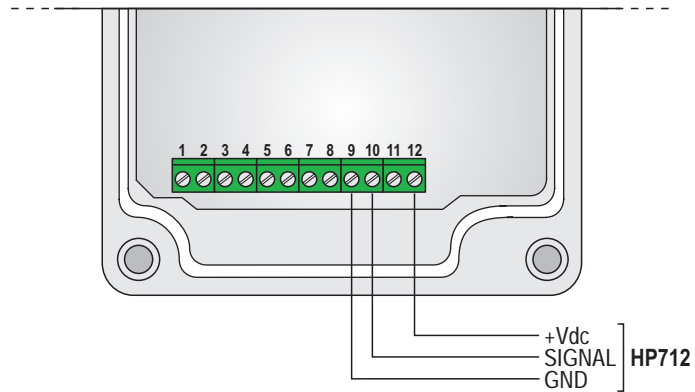

Fig. 3.8.1: connection of the HP712 level sensor

4 CONNECTION TO THE NETWORK

4.1 NETWORK CONNECTION / DISCONNECTION

As soon as the data logger is powered, it automatically tries to connect to the LoRaWAN® network server.

If necessary, the data logger connection button, pressed for at least 5 seconds, allows connecting / disconnecting the data logger.

In the indoor models, the connection button is on the front panel. In the outdoor models, the connection button is internal and is indicated with CONNECT / DISCONNECT on the electronic board.

The activation of the connection procedure is signaled by the lightning-up of the green RF LED for one second and by a beep of the buzzer. Successively, the red RF LED will start blinking until the device is connected.

For the connection to the network, a LoRaWAN® gateway must be present within the data logger coverage range.

4.2 GATEWAY

Unless LoRaWAN® coverage is already present in your area, you need to use your own gateway.

If the gateway is supplied by Delta OHM, it is normally already configured for connection to the LoRaWAN® network server, and it is sufficient to insert a SIM, if the gateway has a cellular connection, or connect the gateway to your LAN/WLAN network, if the gateway has Wi-Fi or ETHERNET connection.

If the gateway is not supplied by Delta OHM, the user must set the gateway to connect to the desired LoRaWAN® network server.

In any case, it is recommended to carefully read the documentation supplied with the gateway.

4.3 WEB APPLICATION

The data sent by the data logger can be viewed on the Delta OHM Cloud or on third-party Clouds.

In the case Delta OHM supplies an already configured gateway and the Delta OHM Cloud is used, the user simply has to register on the Delta OHM Cloud "www.deltaohm.cloud" and enter (during registration or later, if already registered) the data logger serial number: the data will be immediately available. For the use of the Delta OHM Cloud see the instructions downloadable from the www.deltaohm.com website in the "Support" > "Software" screen.

If a third-party Cloud is used, e.g. myDevices, ioThink®, etc., it is the user who must prepare his own data display screens according to the chosen application and the data protocol used (Cayenne LPP or proprietary). For the development of advanced customized applications that interface directly with the network server (e.g. TTN), Delta OHM provides a free Javascript decoder for the proprietary protocol.

5 DATA LOGGERS WITH LCD OPTION

According to the data logger model, the LCD display can be custom (**L** option) or graphic (**G** option) type. The display shows all quantities measured and calculated by the data logger along with the following RF quantities:

- **RSSI** (*Received Signal Strength Indication*): received signal power;
- **PER** (*Packet Error Rate*): percentage of transmission errors;

Note: the HOP1 indication in the screens showing the RF quantities simply indicates that a direct connection exists between the data logger and the gateway.

The indications of connection status, logging (in progress/deactivated), and battery charge level are displayed.

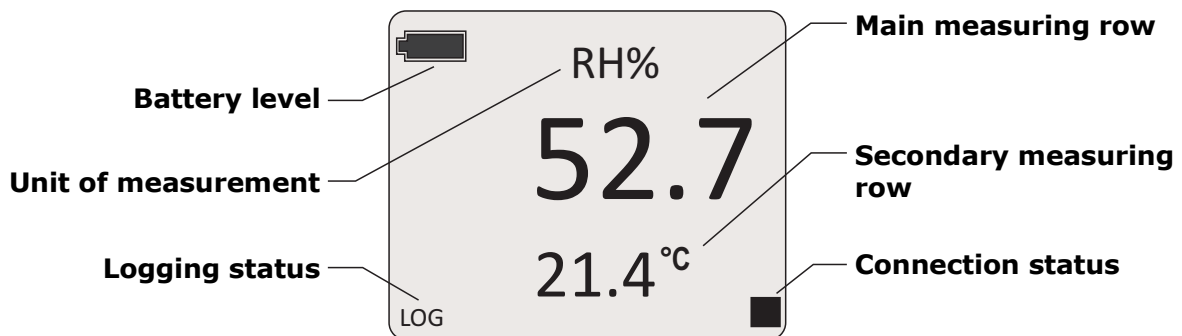

Fig. 5.1: custom LCD

In the models with custom LCD that measure several quantities, the temperature (if measured by the model) is displayed in the secondary row (except when a RF quantity appears in the main row).

The models with graphic LCD allow the simultaneous display of 3 measurements in the secondary rows. The graphic display shows in addition the RF signal level and date & time.

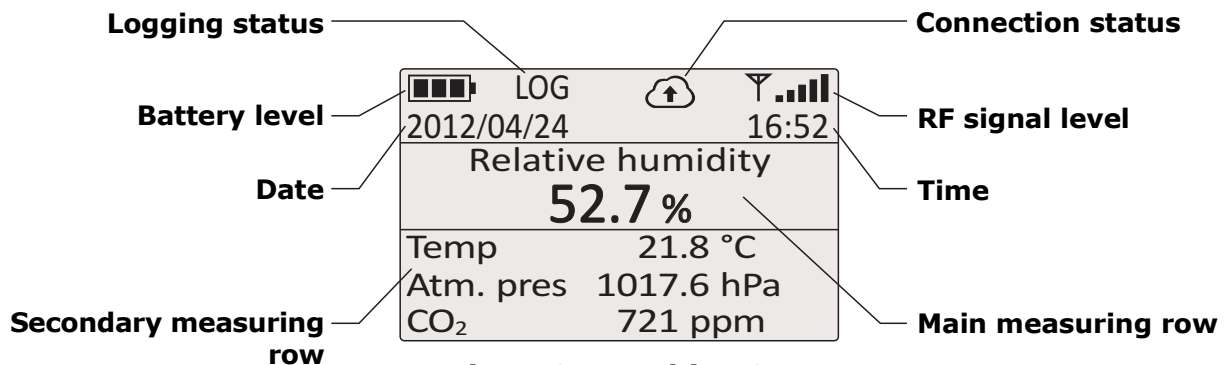

Fig. 5.2: graphic LCD

In the indoor models, use the ▲ key to scroll the quantities on the display. In the outdoor models, through HD35AP-S software you can select the measurement to be displayed on the main measuring row of the display or set the automatic alternation of the measured quantities.

The "connection status" symbol provides the following information:

- symbol steady on: data logger connected;
- symbol blinking: trying to connect;
- symbol off: data logger not connected.

5.1 MAXIMUM, MINIMUM AND AVERAGE OF THE MEASUREMENTS (ONLY INDOOR MODELS)

To display the maximum value (**MAX**), the minimum value (**MIN**) and the average (**AVG**) of the acquired values, press the **FUNC** key until the desired function is shown on the display.

To reinitialize the function value and start a new measuring session, press the **FUNC** key until you read *FUNC CLR* (custom LCD) or *Function clear* (graphic LCD), use the arrow keys to select yes and confirm with **ENTER**.

5.2 MENU (ONLY INDOOR MODELS)

The menu allows displaying the data logger information and changing operation parameters. The menu is structured in levels, with main categories and submenus.

To access the menu you need to enter the **user password** (configurable through the appropriate menu item, default 0000) or the **administrator password** (supplied with the system and not editable). Entering the user password makes some settings not changeable.

The instrument exits automatically the menu if no key is pressed for 3 minutes. After exiting the menu, the password remains active for a few minutes, during which you may enter the menu again without re-entering the password. It is possible to exit the menu by disabling immediately the password by performing a password level reset in the *Password* menu.

5.2.1 The menu in data loggers with graphic LCD

To access a menu parameter, proceed as follows:

1. Press **MENU**.
2. Press ▼ to select the password field.

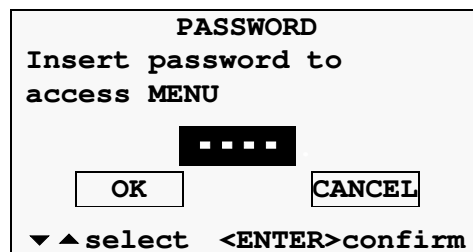

3. Press **ENTER**, the first digit of the password will blink.
4. Use ▼/▲ keys to set the first digit and confirm with **ENTER**, the second digit of the password will blink. Set all the password digits in the same way.
5. Press ▼ to select the option OK and confirm with **ENTER**.
6. Use ▼/▲ keys to select a main category of the menu and confirm with **ENTER**.
7. If the selected main category has a submenu, select the desired item using ▼/▲ and confirm with **ENTER**.

To exit the main menu or a submenu, select the item EXIT (last menu item).

Changing a parameter

After selecting the desired parameter, it can be changed, if allowed, in the following way:

1. Use ▼/▲ keys to highlight the current setting of the parameter.

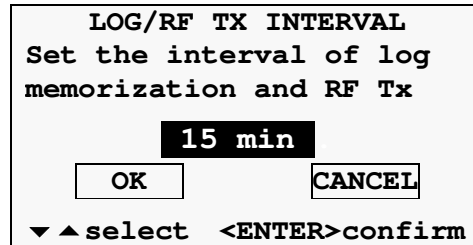

2. Press **ENTER**, the field will start blinking.
3. Use ▼/▲ keys to select the desired setting and confirm with **ENTER**. If you are setting a numeric value, you can move faster by keeping ▼ or ▲ keys depressed.
4. Press ▼ to select the option OK and confirm with **ENTER**. The instrument closes the parameter window and returns to the previous menu level.

To exit a parameter window without changes, select CANCEL and confirm with **ENTER**.

If only the option CANCEL is available in the parameter window, it means that it is not allowed to change the parameter setting.

Menu structure

The complete structure of the main window with the relevant submenus is shown below. According to the data logger model, some items could not be available if not significant for that particular model.

1) Information

It lists the general information of the instrument: model, serial number, device EUI (Extended Unique Identifier), user code, firmware version, calibration date, etc.

3) LoRaWAN parameters

- 1) **Join Network server**: enables or disables the connection to the LoRaWAN® network server. Select *Yes* to enable the connection. The connection enabling or disabling can be done also through the connection button.
- 2) **Duty cycle**: enables or disables the data transmission duty-cycle (time slot in which the data logger transmits). Select *On* to enable the duty-cycle. If enabled, the duty-cycle is automatically set by the instrument according to the regulations in force.
- 3) **Ack mode**: enables or disables the request for acknowledgement of the data sent by the data logger and received by the network. The default setting is *Off* (Ack disabled).
Note: the request for acknowledgement impacts on data transmission duty cycle; leave the option disabled if a limited number of downlink packets are allowed (as for example, for TTN server).
- 4) **Protocol type**: choice of the Cayenne LPP or proprietary (default) protocol.
- 5) **Auto data rate**: enables or disables the data rate automatic setting (Adaptive Data Rate). The default setting is *On* (Auto data rate enabled).

- 6) **Data rate**: data rate manual setting, used if the automatic setting is disabled. It is set the index (0,1,2,...) corresponding to the data rate according to the convention published in the document "LoRaWAN® Regional Parameters" (see "lora-alliance.org").
- 7) **Exit**: returns to the main menu.

4) Ch x settings (x=1, 2, 3) – Only available in the models with configurable inputs

- 1) **Ch x info**: lists all the general information of the input channel Ch x of the instrument: name of measurement, probe type, resolution. The correspondence between the input signal value and the physical quantity value is also indicated for mA, mV, V, Potentiometer and Counter inputs associated with a physical quantity.
- 2) **Ch x configuration**: sets the type of input among the available inputs (see page 11 for setting modes). The input type can be set only with the administrator password.
- 3) **Ch x zero setting**: sets the current measurement value as zero value. Only available for mA, mV, V and Potentiometer inputs associated with a physical quantity.
- 4) **Ch x down threshold**: lower alarm threshold of channel x.
- 5) **Ch x up threshold**: higher alarm threshold of channel x.
- 6) **Ch x reset counter**: zeroes the number of counts. The item is available only if the channel is configured as counter.
- 7) **Exit**: returns to the main menu.

5) Alarm thresholds or Alarm configuration

- 1) **Quantity 1 down threshold**: lower alarm threshold of quantity 1. The type of quantity depends on the data logger model.
- 2) **Quantity 1 up threshold**: higher alarm threshold of quantity 1. The type of quantity depends on the data logger model.
- 3) ...
- 4) **Quantity n down threshold**: lower alarm threshold of quantity n. The type of quantity depends on the data logger model.
- 5) **Quantity n up threshold**: higher alarm threshold of quantity n. The type of quantity depends on the data logger model.
- 6) **Thres. buzzer alarm**: activates or deactivates the buzzer when measurement thresholds are exceeded.
- 7) **Exit**: returns to the main menu.

Note: in the models with configurable inputs, the items down threshold and up threshold of quantities are not available in this submenu, but are included in the menus for the setting of channels Ch x.

6) Measure hysteresis

- 1) **Quantity 1 hysteresis**: hysteresis of the alarm thresholds of quantity 1. The type of quantity depends on the data logger model.
- 2) ...
- 3) **Quantity n hysteresis**: hysteresis of the alarm thresholds of quantity n. The type of quantity depends on the data logger model.
- 4) **Exit**: returns to the main menu.

The width of the hysteresis is a percentage (0 ... 100%) of the difference between the two alarm thresholds.

For example, if Hysteresis=2%, Lower threshold=10 °C and Upper threshold=60 °C, the hysteresis is $(60-10) \times 2 / 100 = 1 \text{ °C}$:

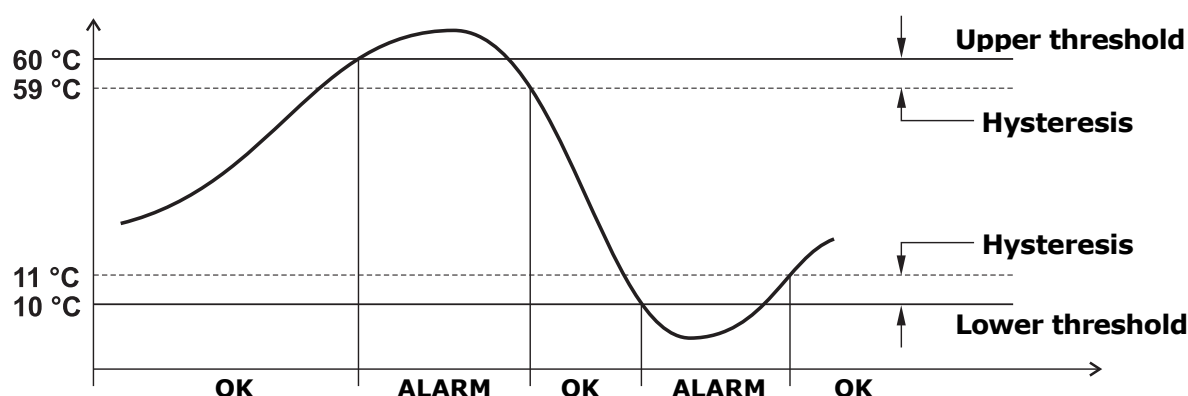

Fig. 5.3: hysteresis of the alarm thresholds

7) Alarm time delay (in seconds)

- 1) **Quantity 1 alarm delay**: delay for alarm activation of quantity 1. The type of quantity depends on the data logger model.
- 2) ...
- 3) **Quantity n alarm delay**: delay for alarm activation of quantity n. The type of quantity depends on the data logger model.
- 4) **Exit**: returns to the main menu.

If the measured value drops below the lower threshold or exceeds the upper threshold, the alarm is generated after the time set. The alarm is generated immediately if 0 is set. If the alarm condition ends before the delay time is elapsed, the alarm is not generated.

8) Unit measures

- 1) **Quantity 1**: measurement unit of quantity 1. The type of quantity depends on the data logger model.
- 2) ...
- 3) **Quantity n**: measurement unit of quantity n. The type of quantity depends on the data logger model.
- 4) **Exit**: returns to the main menu.

Note: in the HD35EDH model, only the temperature measurement unit is available. Measurement units for the other quantities are configurable in the menus for the setting of channels Ch x.

9) Logging

- 1) **Start/stop log**: enables or disables logging.
- 2) **Logging mode**: choice between cyclical management (the new data overwrite the old ones when the memory is full) or non-cyclical management (logging stops when the memory is full) of the data logger memory.
- 3) **Log/RF Tx interval**: choice of logging and RF transmission interval (the two intervals coincide). If it is higher than the measuring interval, the average of the measurements acquired during the interval will be stored.

- 4) **Measure interval:** choice of the measurements acquisition interval. It is forced to the value *RF log/Tx interval* if a higher value is set.
- 5) **Log erase:** deletes all stored measurements from the data logger memory.
- 6) **Exit:** returns to the main menu.

10) Clock

- 1) **Clock Configuration:** date/time of data logger.
- 2) **Exit:** returns to the main menu.

11) Password

- 1) **Reset password level:** exits menu disabling immediately the password (the password will not remain active for some minutes like it usually happens when exiting a menu: you will have to re-enter the password even if you access the menu at once).
- 2) **User password config.:** sets the user level password.
- 3) **Exit:** returns to the main menu.

12) CO₂ auto calibration

- 1) **Start/stop auto-calib.:** enables or disables CO₂ auto-calibration.
- 2) **Auto-calib. period:** time interval between two consecutive auto-calibrations.
- 3) **Auto-cal. 1st period:** time interval after which the first auto-calibration will be performed after activation.
- 4) **Background CO₂ value:** CO₂ reference value for auto-calibration.
- 5) **Auto-cal. max change:** maximum offset that can be applied to the measurement by the auto-calibration procedure.
- 6) **Exit:** returns to the main menu.

13) Calibration – Only available with administrator password

- 1) **RH 75% calibration**
- 2) **RH 33% calibration**
- 3) **CO₂ calibration**
- 4) **Atm. pressure config.:** manual setting of the atmospheric pressure, used to compensate CO₂ measurements if the data logger has no integrated pressure sensor.
- 5) **Calibration Type:** choice between user calibration and factory calibration.
- 6) **Exit:** returns to the main menu.

Note: according to the data logger model, some items could not be available if not significant for that particular model.

14) Language

- 1) **Language config.:** choice of the language to be used for the display.
- 2) **Exit:** returns to the main menu.

15) Exit

Returns to the measurement mode.

5.2.2 The menu in data loggers with custom LCD

To access a menu parameter, proceed as follows:

1. Press **MENU**, the first digit of the password will blink.
2. Using ∇/\blacktriangle keys, set the first digit and confirm with **ENTER**, the second digit of the password will blink. Set all the password digits in the same way.
3. Using ∇/\blacktriangle keys, select a main category in the menu and confirm with **ENTER**. Menu items appear one at a time in the upper part of the display; the lower part of the display shows the position of the item in the menu and the total number of items in the menu (for ex. "8 - 10" means the eighth item in a menu of 10 items).

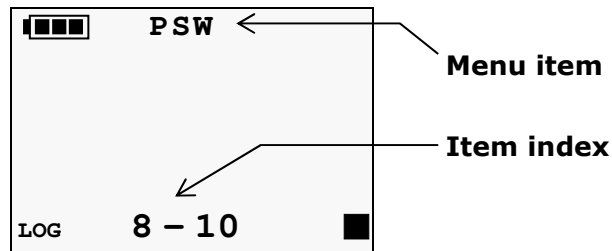

4. If the selected main category has a submenu, select the desired item using ∇/\blacktriangle keys and confirm with **ENTER**. Scrolling the submenus displays also the parameter current setting.
5. To change the selected parameter, if allowed, use ∇/\blacktriangle keys to select the desired setting and confirm with **ENTER**. If you are setting a numeric value, you can fast forward by keeping ∇ or \blacktriangle keys depressed.

To exit the main menu or a sub menu, select EXIT item (last menu item).

If it is not allowed to change a parameter, the notice N/A (Not Available) will appear when pressing ENTER to select it.

Menu structure

The complete structure of the main menu with the relevant submenus is shown below. According to the data logger model, some items could be not available if not significant for that particular model.

1) DEV_INFO (information)

It lists the general information of the instrument: model, serial number, device EUI (Extended Unique Identifier), user code, firmware version, calibration date, etc. Information is shown in the upper part of the display.

2) LORA_WAN_MENU (LoRaWAN® parameters)

- 8) **JOIN_NET**: enables or disables the connection to the LoRaWAN® network server. Select *YES* to enable the connection. The connection enabling or disabling can be done also through the connection button.
- 9) **DUTY_CYCL**: enables or disables the data transmission duty-cycle (time slot in which the data logger transmits). Select *On* to enable the duty-cycle. If enabled, the duty-cycle is automatically set by the instrument according to the regulations in force.
- 10) **ACK_MODE**: enables or disables the request for acknowledgement of the data sent by the data logger and received by the network. The default setting is *OFF* (Ack disabled).

Note: the request for acknowledgement impacts on data transmission duty

cycle; leave the option disabled if a limited number of downlink packets are allowed (as for example, for TTN server).

- 11) **PROT_TYPE**: choice of the protocol. Select "0" for the Cayenne LPP standard protocol. Select "1" for the proprietary protocol (default).
- 12) **AUTO_DATA_RATE**: enables or disables the data rate automatic setting (Adaptive Data Rate). The default setting is *On* (Auto data rate enabled).
- 13) **DATA_RATE**: data rate manual setting, used if the automatic setting is disabled. It is set the index (0,1,2,...) corresponding to the data rate according to the convention published in the document "LoRaWAN® Regional Parameters" (see "lora-alliance.org").
- 14) **EXIT**: returns to the main menu.

3) THLD_MENU (alarm thresholds)

- 1) **Quantity 1_DOWN_THLD**: lower alarm threshold of quantity 1. The type of quantity depends on the data logger model.
- 2) **Quantity 1_UP_THLD**: higher alarm threshold of quantity 1. The type of quantity depends on the data logger model.
- 3) ...
- 4) **Quantity n_DOWN_THLD**: lower alarm threshold of quantity n. The type of quantity depends on the data logger model.
- 5) **Quantity n_UP_THLD**: higher alarm threshold of quantity n. The type of quantity depends on the data logger model.
- 6) **THLD_ALARM**: enables or disables the buzzer when measurement thresholds are exceeded.
- 7) **EXIT**: returns to the main menu.

4) HYST_MENU (hysteresis of the alarm thresholds)

- 1) **Quantity 1_HYST%**: hysteresis of the alarm thresholds of quantity 1. The type of quantity depends on the data logger model.
- 2) ...
- 3) **Quantity n_HYST%**: hysteresis of the alarm thresholds of quantity n. The type of quantity depends on the data logger model.
- 4) **EXIT**: returns to the main menu.

The width of the hysteresis is a percentage (0 ... 100%) of the difference between the two alarm thresholds.

For example, if Hysteresis=2%, Lower threshold=10 °C and Upper threshold=60 °C, the hysteresis is $(60-10) \times 2 / 100 = 1$ °C (see the example graph on page 21).

5) ALRM_DELY_MENU (delay time in seconds for alarm activation)

- 1) **Quantity 1_ALRM_DELY**: delay for alarm activation of quantity 1. The type of quantity depends on the data logger model.
- 2) ...
- 3) **Quantity n_ALRM_DELY**: delay for alarm activation of quantity n. The type of quantity depends on the data logger model.
- 4) **EXIT**: returns to the main menu.

If the measured value drops below the lower threshold or exceeds the upper threshold, the alarm is generated after the time set. The alarm is generated im-

mediately if 0 is set. If the alarm condition ends before the delay time is elapsed, the alarm is not generated.

6) MEAS_UNIT_MENU (measurement unit)

- 1) **Quantity 1_UNIT_MEAS**: measurement unit of quantity 1. The type of quantity depends on the data logger model.
- 2) ...
- 3) **Quantity n_UNIT_MEAS**: measurement unit of quantity n. The type of quantity depends on the data logger model.
- 4) **EXIT**: returns to the main menu.

7) LOG_MENU (logging)

- 1) **LOG_STAT**: enables or disables the logging.
- 2) **LOG_CYCL**: choice between cyclical management (the new data overwrite the old ones when the memory is full) or non-cyclical management (logging stops when the memory is full) of the data logger memory. Select **YES** for the cyclical management.
- 3) **LOG/RF_TIME**: choice of logging and RF transmission interval (the two intervals coincide). If it is higher than the measuring interval, the average of the measurements acquired during the interval will be stored.
- 4) **MEAS_TIME**: choice of the measurements acquisition interval. It is forced to the value *Log/RF_TIME* if a higher value is set.
- 5) **LOG_DEL**: deletes all stored measurements from the data logger memory. Select **YES** to delete the memory.
- 6) **EXIT**: returns to the main menu.

8) CLK_MENU (clock)

- 1) **YEAR**: year.
- 2) **MON**: month.
- 3) **DAY**: day.
- 4) **HOURL**: hour.
- 5) **MIN**: minutes.
- 6) **EXIT**: returns to the main menu.

9) PSW_MENU (password)

- 1) **RST_PSW_LVL**: exits the menu and deactivates immediately the password (the password will not remain active for some minutes as it normally happens when exiting the menu: you will need to re-enter the password even if you re-access immediately the menu).
- 2) **SET_NEW_PSW**: sets user-level password.
- 3) **EXIT**: returns to the main menu.

10) CAL_MENU (calibration) – *Only available with administrator password*

- 1) **RH_75%_CAL**: relative humidity sensor calibration at 75%RH.
- 2) **RH_33%_CAL**: relative humidity sensor calibration at 33%RH.
- 3) **DIFF_PRES_AUTO_ZERO_CAL**: enables or disables the automatic differential pressure zero calibration in models with auto-zero.

- 4) **DIFF_PRES_AUTO_ZERO_INT_min**: setting of the periodic interval of the differential pressure automatic zero calibration in models with auto-zero.
- 5) **DIFF_PRES_0 Pa_CAL**: calibration of differential pressure to zero.
- 6) **CAL_TYPE**: choice between user calibration (*USER*) or factory calibration (*FACT*).
- 7) **EXIT**: returns to the main menu.

Note: according to the data logger model, some items could not be available if not significant for that particular model.

12) EXIT

Returns to measurement mode.

6 CALIBRATION

The data logger is factory-calibrated and does not normally require further interventions of the user. Anyway, a new sensor calibration can be performed for:

- CO₂ at any reference value within the measurement range
- Differential pressure at zero
- R.H. at 75% and 33%

For a correct calibration of the probes, it is crucial to know and respect the physical phenomena which underlie measurements: for this reason, it is recommended to thoroughly follow the following instructions and to perform new calibrations only if in possession of adequate technical knowledge and instruments.

To access calibration, the data logger must have the user-calibration option set:

- In the indoor models with graphic LCD, select the menu item *Calibration* ⇒ *Calibration Type* and set the *User* option.
- In the indoor models with custom LCD, select the menu item *CAL_MENU* ⇒ *CAL_TYPE* and set the *User* option.

The calibration procedure deletes the data of the previous user calibration. In case of failed procedure, you can always return the instrument to factory calibration by selecting:

- In the indoor models with graphic LCD, the menu item *Calibration* ⇒ *Calibration Type* and setting the *Factory* option;
- In the indoor models with custom LCD, the menu item *CAL_MENU* ⇒ *CAL_TYPE* and setting the *FACT* (factory) option.

Calibration can be performed with HD35AP-S software (see software instructions) or, if the data logger has display and keyboard, through the front keyboard.

6.1 CO₂ CALIBRATION

The CO₂ sensor can be calibrated to any reference value within the measurement range.

Calibration procedure:

1. Place the instrument in an environment with known CO₂ concentration (for ex. in clean air).
2. Wait for at least 15 minutes for the measurement to become stable, with the instrument on.
3. Access the menu with the administrator password and select the item *Calibration* ⇒ *CO₂ calibration*. Press **ENTER** to confirm.
4. The value measured by the instrument appears on the left, and the calibration point on the right. The instrument initially proposes the same measurement value as calibration point.
5. Enter the calibration value, select the option OK and confirm with **ENTER**.

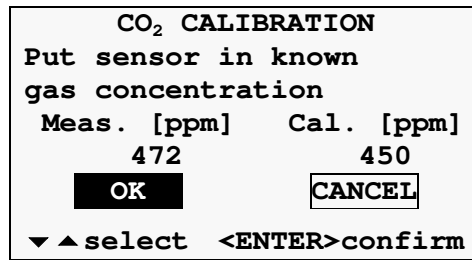

6. The instrument tests the measurement stability. Wait for a few minutes for measurement completion. In the meantime, don't stay too close to the instrument to avoid altering the measurement.

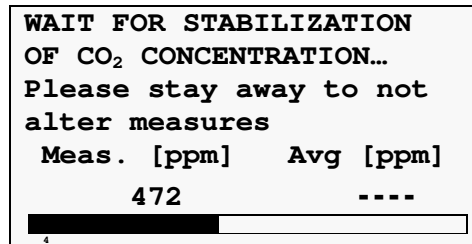

7. At the end, a message is shown indicating the calibration success or failure. Press any key to return to the calibration submenu.

If a message appears declaring that calibration has failed, it means that the value measured by the instrument during the procedure differs too much from the set reference value. In that case repeat calibration checking the CO₂ reference value in the environment and making sure to operate in a stable environment.

6.1.1 CO₂ SENSOR AUTO-CALIBRATION

The instrument can be set so as CO₂ calibration is automatically performed at predetermined intervals.

In order for auto calibration to be effective, the CO₂ concentration in the environment where the instrument is installed must assume a known value (referred to as environment **background value**). For example, we can have that an instrument installed inside a public place performs a weekly auto calibration when people are not present and CO₂ concentration is close to the outdoor air value (if there is an adequate air change).

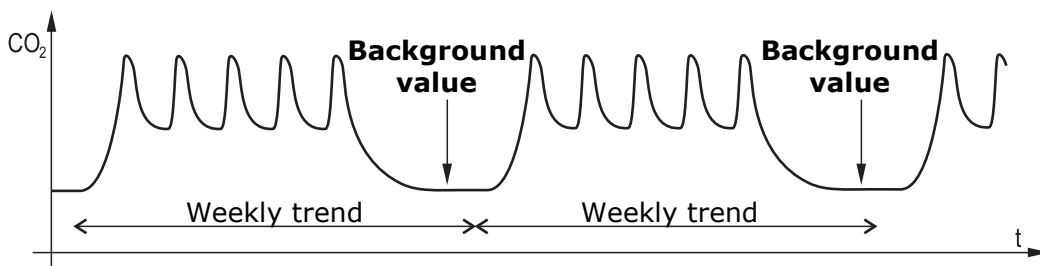

Fig. 6.1.3: example of background value for CO₂ auto calibration

The offset applied to the measurement by the auto calibration procedure can be limited to a maximum value, so as to avoid erroneous calibrations when the measured value differs too much from the estimated background value. The auto calibration procedure acts therefore in the following way:

- If the difference between the measured value and the background value is lower than the maximum offset, an offset is applied to the measurement so that the measured value coincides with the background value.
- If the difference between the measured value and the background value is higher than the maximum offset, only the maximum offset is added or subtracted so as to approach the background value.

To set the auto calibration interval and the maximum offset and to activate auto calibration, see the menu item *CO₂ autocalibration*.

6.2 DIFFERENTIAL PRESSURE CALIBRATION

Differential pressure sensors may show a slight difference between the two inputs, consequently the instrument, with an equal pressure applied to the two inputs, doesn't show a zero value. Proceed as follows for the zeroing of the differential value.

Calibration procedure:

1. Leave the instrument pressure input open.
2. Access menu with the administrator password and select the item *CAL_MENU* ⇒ *DIFF_PRES_0 Pa_CAL*. Press **ENTER** to confirm.
3. The zero value blinks on the display.

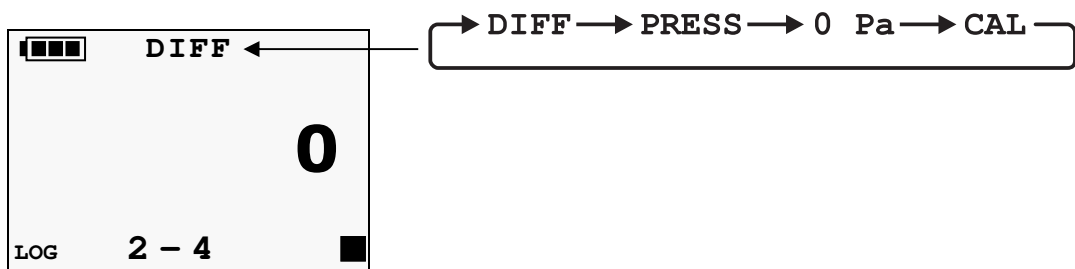

4. Press **ENTER**, the instrument stores the calibration and returns to the calibration submenu.

6.3 RELATIVE HUMIDITY CALIBRATION

The sensor can be calibrated in the two points 75%RH and 33%RH. Before starting the calibration procedure, it's better to **check** if a new calibration is necessary, with the aid of 75.4%RH and 33%RH saturated solutions (except LR35[G]1NB, that requires a climatic chamber): a calibration will be performed only if an error of a few humidity points in one of the two calibration points is detected.

The sensor can be calibrated in both points or in one point only.

Preliminary operations before calibration:

Check that the chamber with the saturated saline solutions contains at the same time:

- solid state salt,
- liquid solution or wet salt, in particular for the 75%RH solution.

The instrument and the saturated solutions to be used for this operation must be placed in a stable temperature environment for the whole calibration period. Wait for at least a couple of hours with a stable temperature so that the instrument and the saturated solutions reach a thermal balance with the environment before starting the calibration

procedure. In order to obtain a good calibration, it is crucial that the probe and the solution have the same temperature. Bear in mind that plastic material is a bad heat conductor.

Calibration should be performed at a temperature ranging within 15 and 30°C.

Calibration procedure:

1. Unscrew the probe protection grid and screw the M12×1 threaded ring.
 Avoid any contact of the sensitive element with your hands or other objects or liquids. **If some liquid has formed inside the measuring chamber, dry it with a clean absorbent paper towel.**
2. Unscrew the cap of the saturated solution. Screw the threaded ring with the probe on the saturated solution container and wait for at least 30 minutes.
3. Access the menu with the administrator password and select the item *CAL_MENU* (custom LCD) or *Calibration* (graphic LCD). Press **ENTER** to confirm.
4. Select the item *RH_75%_CAL* (custom LCD) or *RH 75% calibration* (graphic LCD) to calibrate the point 75%RH; select the item *RH_33%_CAL* (custom LCD) or *RH 33% calibration* (graphic LCD) to calibrate the point 33%RH. Press **ENTER** to confirm.
5. In the models with custom LCD, the blinking value of the saturated solution at the temperature measured by the probe is displayed. In the models with graphic LCD, the value measured by the instrument (on the left) and the calibration point (on the right) appear.

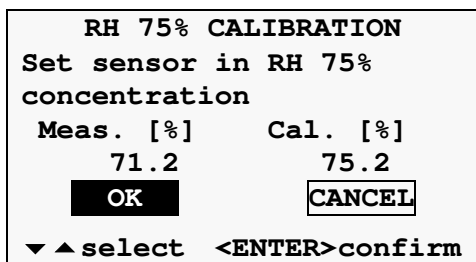

Graphic LCD

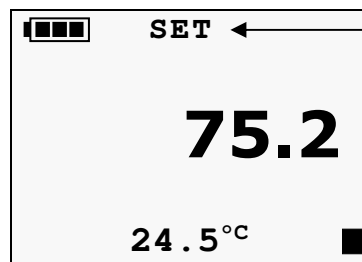

Custom LCD



Note: the suggested calibration value is not updated if the measured temperature changes after starting calibration. If necessary, set manually the calibration value to the value of the saturated solution at the measured temperature using ▼/▲ keys (see the table on the saturated solution container).

6. In the models with custom LCD, press **ENTER** to confirm the value; in the models with graphic LCD, select the option OK and confirm with **ENTER**. The instrument stores the calibration and returns to the calibration submenu.
7. Remove the threaded ring with the probe from the container of the saturated solution and close the container with the solution.
8. To calibrate the second point, repeat the procedure from step 2 to step 7 with the second saturated solution.
9. Unscrew the M12X1 threaded ring from the probe and place again the sensor protection grid.

7 TECHNICAL CHARACTERISTICS

General characteristics

| | |
|--|---|
| RF band | EU868, US915, AU915, AS923 depending on model Other frequencies on request |
| Antenna | Internal in indoor models and in LR35W[B]PM External in outdoor models (except LR35W[B]PM) |
| RF power | +14 dBm |
| LoRaWAN Class | A |
| Activation methods | OTAA (Over-The-Air-Activation) ABP (Activation-by-Personalization) |
| Data encryption | AES128 |
| Measuring interval | 1(*), 2, 5, 10, 15, 30 s / 1, 2, 5, 10, 15, 30, 60 min |
| Data transmitting interval | 2, 5, 10, 15, 30, 60 min |
| Alarm | Acoustic by means of the internal buzzer |
| Power supply | 7...30 Vdc (< 10 mA) external power supply for LR35W-MB 3 x AA alkaline batteries for LR354r1Z and LR351N4r1ZTV Li-SOCl ₂ not rechargeable battery for all the other models |
| Battery life (**) (typical, with 2 min data transmitting interval) | 3 years for LR35WH (10 s meas. intv.) 1.5 years for LR351NB (2 min meas. intv.) 2 years for all the other models (5 s meas. intv., 10 s for LR35H) |
| Display | Optional, custom or graphic LCD depending on the model LR35W[B]PM is not available with display |
| Operating conditions | -20...+70 °C (-10...+70 °C for LR351NB) 0...85 %RH not condensing for indoor models 0...100 %RH for outdoor models (0...95 %RH for LR35WPM) |
| Protection Degree | IP 50 for indoor models (except LR351NB) IP 67 for outdoor models (except LR35WPM) LR35WPM is equipped with a rain-proof and UV resistant inlet air filter – IP 53 |
| Weight | 200 g approx. for indoor models 250 g approx. for outdoor models |
| Housing | ABS for indoor models Polycarbonate for outdoor models |

(*) Models measuring several quantities may have a minimum interval exceeding 1 second.

(**) Battery life is greatly reduced if the USB port is left connected to the PC for a long time.

Memory capacity and stored quantities

| Model | Number of samples (**) | Stored quantities (*) |
|-----------------------|------------------------|--|
| Indoor models | | |
| LR357P/1TC | 68,000 | T |
| LR357P/3TC | from 42,000 to 68,000 | T |
| LR351NTC | from 24,000 to 60,000 | T, RH, T _D , T _w , AH, MR, PVP |
| LR351NTV | from 24,000 to 60,000 | T, RH, T _D , T _w , AH, MR, PVP |
| LR3514bNTV | from 22,000 to 60,000 | T, RH, T _D , T _w , AH, MR, PVP, P _{ATM} |
| LR351N4r1ZTV | from 22,000 to 60,000 | T, RH, T _D , T _w , AH, MR, PVP, ΔP |
| LR354r1Z | 68,000 | ΔP |
| LR351NB | from 44,000 to 120,000 | T, RH, T _D , T _w , AH, MR, PVP, CO ₂ |
| LR35H | from 36,000 to 68,000 | |
| Outdoor models | | |
| LR35W1NTC | from 24,000 to 60,000 | T, RH, T _D , T _w , AH, MR, PVP |
| LR35W1NTV | from 24,000 to 60,000 | T, RH, T _D , T _w , AH, MR, PVP |
| LR35WPTC | from 26,000 to 58,000 | P, D _p , I _p , CNT, FRQ |
| LR35WDPTC | from 24,000 to 52,000 | F _L , P _{REL} , P, D _p , I _p |
| LR35WS/1TC | from 42,000 to 68,000 | T, VWC |
| LR35WS/3TC | from 18,000 to 52,000 | T, VWC |
| LR35WRTC | from 42,000 to 68,000 | R, D _R , mV |
| LR35WPM | from 34,000 to 60,000 | PM1.0, PM2.5, PM10, P _{ATM} |
| LR35WBPM | from 26,000 to 60,000 | PM1.0, PM2.5, PM10, CO ₂ , P _{ATM} |
| LR35WH | from 28,000 to 58,000 | |
| LR35W-MB | from 14,000 to 52,000 | |

(*) List of the quantities:

| | |
|--|---|
| AH: absolute humidity | ΔP: differential pressure |
| CNT: number of detected pulses | P_{ATM}: atmospheric pressure |
| CO₂: carbon dioxide | P_{REL}: relative pressure |
| D_p: daily rainfall quantity | PM_{xx}: particulate matter with a diameter of less than xx μm |
| D_R: daily solar radiation (Wh/m ²) | PVP: partial vapour pressure |
| F_L: fluid level | R: solar radiation (pyranometer) |
| FRQ: frequency of detected pulses | RH: relative humidity |
| I_p: rainfall rate (mm/h) | T: temperature |
| MR: mixing ratio | T_D: dew point |
| mV: pyranometer output in mV | VWC: soil volumetric water content |
| P: rainfall quantity | |

(**) The number of samples depends on the number of stored quantities. A sample consists of all the quantities measured and/or calculated enabled for storing.

Measurement characteristics (except LR35[W]H) - Instrument in line with sensor

| Temperature - NTC Sensor LR35[W]1NTC, LR35[W]1NTV, LR3514bNTV, LR351N4r1ZTV | |
|---|---|
| Sensor | NTC 10 k Ω @ 25 °C |
| Measuring range | -40...+105 °C |
| Resolution | 0.1 °C |
| Accuracy | ± 0.3 °C in the range 0...+70 °C / ± 0.4 °C outside |
| Stability | 0.1 °C/year |
| Temperature - Pt100/Pt1000 Sensor LR357P/xTC | |
| Sensor | Pt100 / Pt1000 1/3 DIN |
| Measuring range | -100...+350 °C |
| Resolution | 0.1 °C |
| Accuracy | 1/3 DIN |
| Stability | 0.1 °C/year |
| Temperature – Sensor integrated in RH module LR351NB | |
| Sensor | Sensor integrated in humidity module |
| Measuring range | -40...+105 °C |
| Resolution | 0.1 °C |
| Accuracy | ± 0.2 °C in the range 0...+60 °C $\pm (0.2 - 0.05 * T)$ °C in the range T=-40...0 °C $\pm [0.2 + 0.032 * (T-60)]$ °C in the range T=+60...+105 °C |
| Stability | 0.05 °C/year |
| Relative Humidity LR35[W]1NTC, LR35[W]1NTV, LR3514bNTV, LR351N4r1ZTV | |
| Sensor | Capacitive |
| Measuring range | 0...100 %RH |
| Resolution | 0.1 % |
| Accuracy @ T=15...35 °C @ T= remaining range | ± 1.8 %RH (0..85 %RH) / ± 2.5 %RH (85...100 %RH) $\pm (2 + 1.5\% \text{ measure})$ %RH |
| Sensor operating temperature | -20...+80 °C standard / -40...+105 °C with HP3517W... probe |
| Response time | T ₉₀ < 20 s (air speed = 2 m/s without filter) |
| Stability | 1%/year (in the whole temperature and RH range) |
| Relative humidity LR351NB | |
| Sensor | Capacitive |
| Measuring range | 0...100 %RH |
| Resolution | 0.1 % |
| Accuracy @ T=23 °C | ± 2.5 %RH (0..85 %RH) / ± 3.5 %RH (85...100 %RH) |
| Temperature drift | 0.05 %RH/K (0..60 °C) |
| Sensor operating temperature | -40...+105 °C (R.H. max=[100-2*(T-80)] @ T=80...105 °C) |
| Response time | T ₆₃ < 4 s (air speed = 2 m/s, without filter) |
| Stability | < 1%/year (@ 23 °C and 30...70 %RH) |

| Atmospheric Pressure LR3514bNNTV | |
|--|--|
| Sensor | Piezo-resistive |
| Measuring range | 300...1100 hPa |
| Resolution | 0.1 hPa |
| Accuracy @ T=25 °C @ T= 0...50 °C | ± 0.5 hPa (800...1100 hPa) ± 1 hPa (300...1100 hPa) |
| Stability | 1 hPa/year |
| Temperature drift | ±3 hPa @ T=-20...+60 °C |
| Atmospheric Pressure LR35W[B]PM | |
| Sensor | Piezo-resistive |
| Measuring range | 300...1250 hPa |
| Resolution | 0.1 hPa |
| Accuracy @ T=-20...65 °C | ± 0.5 hPa (300...1100 hPa) |
| Stability | 0.33 hPa/year |
| Temperature drift | ± 0.75 Pa/°C (0...55 °C / 700...1100 hPa) |
| Differential Pressure | |
| Sensor | Piezoresistive |
| Measuring range | ±100 Pa |
| Resolution | 0.01 hPa |
| Accuracy @ T=25 °C | ± (0.8% measure + 0.5) Pa |
| Stability | ± 0.2 Pa with zero self-calibration |
| Connection | Tube Ø 5 mm |
| Carbon Dioxide (CO₂) | |
| Sensor | Non-dispersive infrared rays (NDIR) |
| Measuring range | 0...5000 ppm |
| Resolution | 1 ppm |
| Accuracy | ± (50 ppm + 3% measure) @ 25 °C and 1013 hPa |
| Operating conditions | 0...50 °C / 0...95 %RH non condensing / 950...1050 hPa |
| Response time | T ₉₀ < 120 s (air speed= 2 m/s) |
| Stability | 5% measure/5 years (with autocalibration enabled) |
| Non-linearity | < 1% f.s. |
| Particulate Matter (PM) | |
| Measuring principle | Laser scattering |
| Pollutants detected | PM1.0, PM2.5, PM10 |
| Measuring range | 0...1000 µg/m ³ (for each pollutant) |
| Resolution | 0.1 µg/m ³ |
| Linearity error | < 5% |
| Repeatability | < 3% |
| Warm up time | < 15 s |
| Temperature drift | < 0.01 µg/m ³ /°C |

| Rainfall quantity (*) | |
|--------------------------------------|---|
| Sensor | Tipping bucket with NC or NO configurable contact |
| Resolution | Configurable 0.1 – 0.2 – 0.5 mm/tipping |
| Solar radiation (*) | |
| Sensor | Thermopile |
| Measuring range | 0...2000 W/m ² |
| Resolution | 1 W/m ² |
| Sensitivity | Configurable in mV/(kW m ⁻²) |
| Soil volumetric water content | |
| Measuring principle | Capacitive |
| Measuring range | 0...60% VWC (Volumetric Water Content) |
| Resolution | 0.1% |
| Accuracy | ± 3 % between 0 and 50% VWC (standard mineral soil up to 5 mS/cm) |
| Sensor working temperature | -40...+60 °C |
| Level | |
| Sensor | Sensor of pressure relative to the atmosphere |
| Pressure measuring range | 0...1 bar |
| Level measuring range | Depends on the fluid density (configurable via software) For water: 0...10 m approx. |
| Resolution | 1 hPa / 0,01 m (for water) |
| Accuracy | ± 0.8% f.s. @ 25 °C |

(*) Measurement characteristics not reported depend on the external sensor connected, please refer to the data sheet of the chosen external sensor.

LR35[W]H measurement characteristics

| Pt100 / Pt1000 | |
|---|--|
| Measuring range | -200...+650 °C |
| Resolution | 0.1 °C |
| Accuracy | ± 0.1 °C (excluding probe error) |
| Sensor coefficient | $\alpha=0.00385 \text{ } ^\circ\text{C}^{-1}$ |
| Connection | 2, 3 or 4 wires |
| Thermocouple | |
| Thermocouple type | K, J, T, N, E. The inputs are not isolated, use thermocouples with isolated hot junction. |
| Measuring range | Type K: -200...+1370 °C Type J: -100...+750 °C Type T: -200...+400 °C Type N: -200...+1300 °C Type E: -200...+750 °C |
| Resolution | 0.1 °C |
| Accuracy (excluding probe error) | Type K: ± 0.1 °C (< 600 °C) Type J: ± 0.1 °C ± 0.2 °C (> 600 °C) Type T: ± 0.1 °C Type N: ± 0.1 °C (< 600 °C) ± 0.2 °C (> 600 °C) Type E: ± 0.1 °C (< 300 °C) ± 0.2 °C (> 300 °C) |
| Current input | |
| Input range | 0...20 mA or 4...20 mA |
| Shunt resistance | Internal (50 Ω) |
| Resolution | 16 bit |
| Accuracy | ± 2 μA |
| Voltage input | |
| Input range | 0...50 mV, -50...50 mV (only LR35WH) 0...1 V, 0...10 V (only LR35WH) |
| Input Resistance | 100 MΩ |
| Resolution | 16 bit |
| Accuracy | ± 0.01% f.s. |
| Inputs for counting the switchings of a voltage-free contact | |
| Switching frequency | 50 Hz max. |
| Hold Time | 10 ms min. |
| Potentiometer input | |
| Potentiometer | Typically 10 kΩ |
| Resolution | 16 bit |
| Accuracy | ± 0.01% f.s. |

Dimensions (mm)

Indoor models

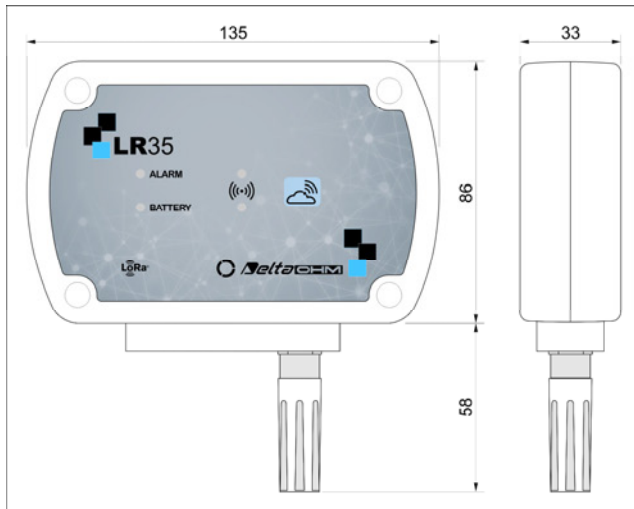

LR35...TV

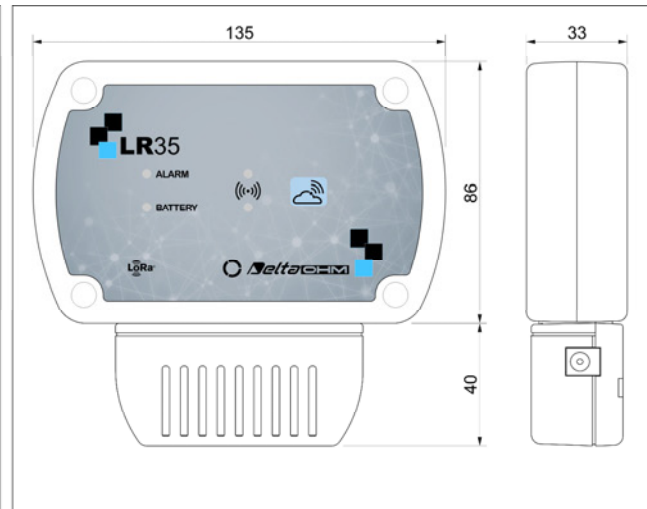

LR351NB

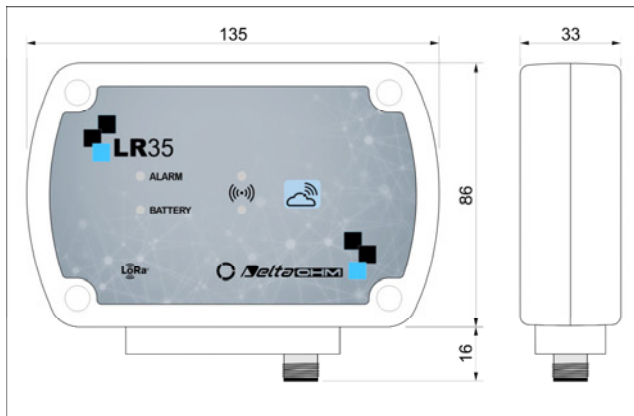

LR35...TC

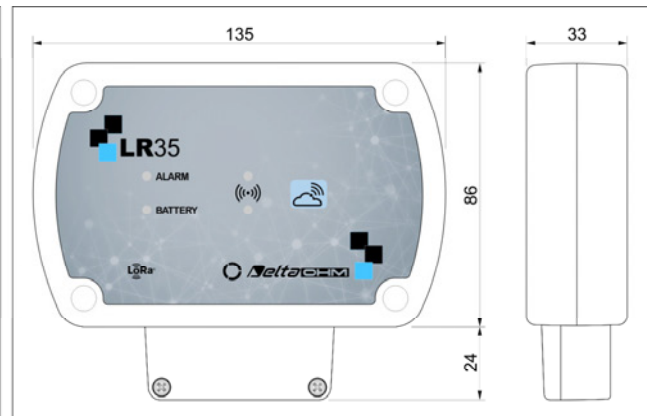

LR35H

The number of connectors depends on the model

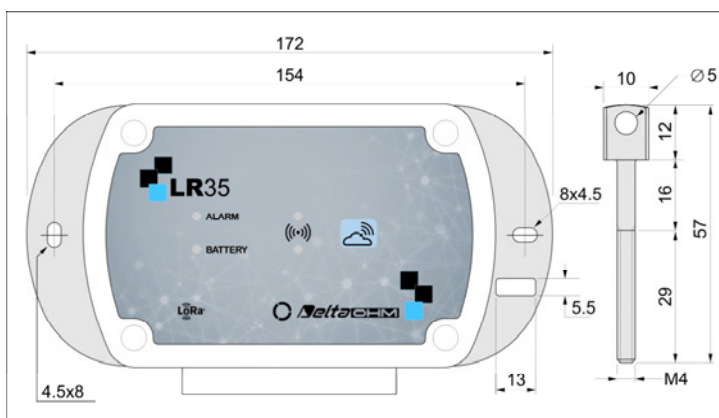

Flanges for fixed installation (HD35.11K)

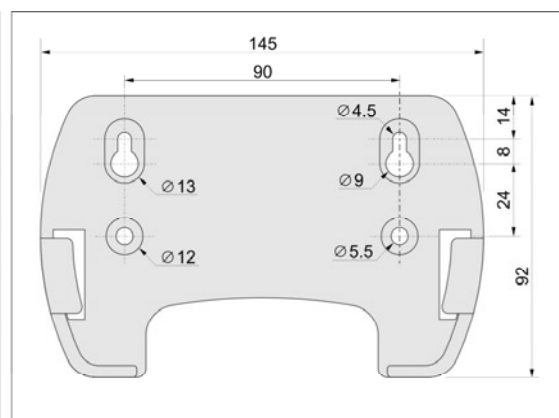

Support for removable installation

Indoor models

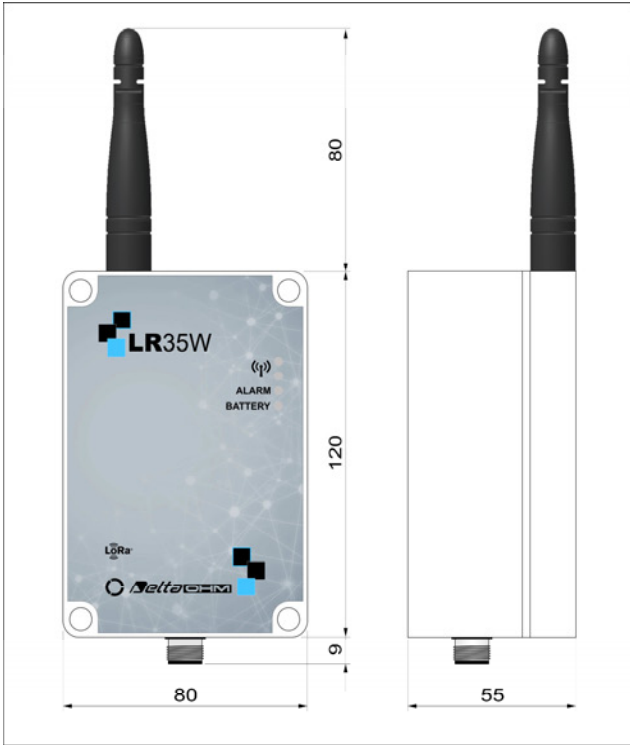

LR35W...TC

The number of connectors depends on the model

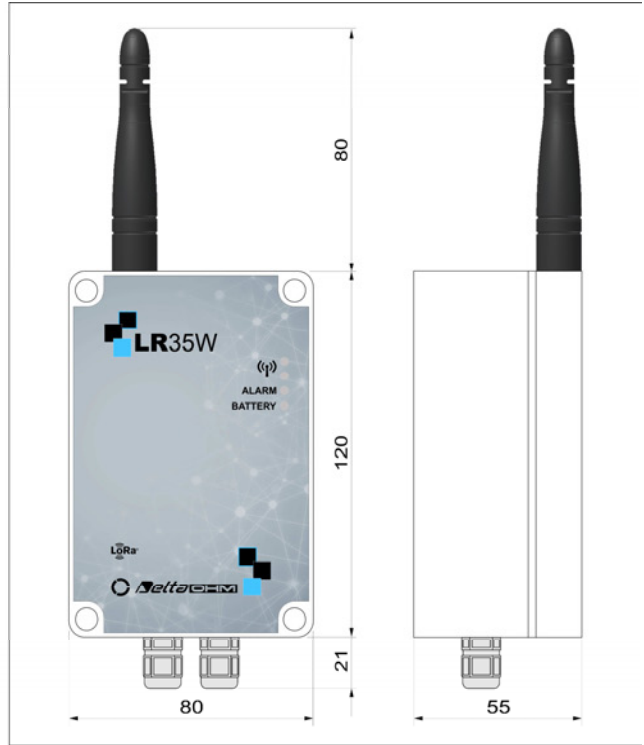

LR35WH / LR35W-MB

The number of cable glands depends on the model

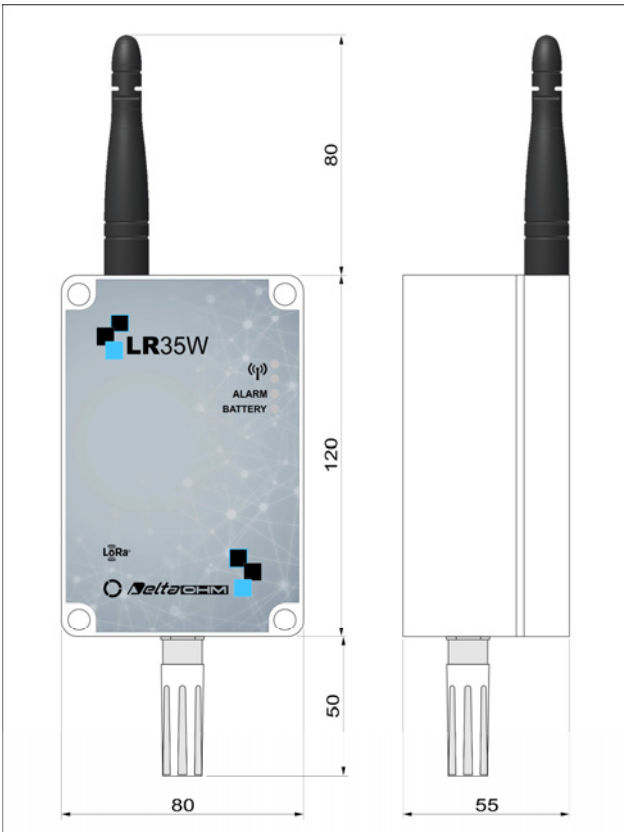

LR35W...TV

8 STORAGE OF INSTRUMENTS

Instruments storage conditions:

- Temperature: -40...+70 °C.
- Humidity: less than 90 %RH no condensation.
- In storage, avoid places where:
 - humidity is high;
 - instruments are exposed to direct sun radiation;
 - instruments are exposed to a high temperature source;
 - high vibration levels are present;
 - there are vapor, salt and/or corrosive gas.

9 SAFETY INSTRUCTIONS

General safety instructions

The instruments have been manufactured and tested in compliance with the safety standard EN61010-1:2010 "Safety requirements for electrical equipment for measurement, control and laboratory use" and left the factory in a safe and secure technical condition.

The instruments proper operation and operating safety can be ensured only if all standard safety measures as well as the specific measures described in this manual are followed.

The instruments proper operation and operating safety can be ensured only in the climatic conditions specified in this manual.

Do not use the instruments in places where there are:

- Rapid ambient temperature variations that may cause condensation.
- Corrosive or flammable gases.
- Direct vibrations or shocks to the instrument.
- High-intensity electromagnetic fields, static electricity.

If the instruments are moved from a cold place to a hot one, or vice versa, condensation formation can cause their malfunction. In this case, you will have to wait for the instruments temperature to reach ambient temperature before turning the instruments on.

User obligations

The instruments operator shall follow the directives and regulations below that refer to the treatment of dangerous materials:

- EEC directives on workplace safety
- National law regulations on workplace safety
- Accident prevention regulations

10 PROBES AND ACCESSORIES ORDERING CODES

TEMPERATURE AND RELATIVE HUMIDITY COMBINED PROBES

HP3517... Temperature and relative humidity combined probe. NTC Temperature sensor. Measuring range: 0...100 %RH / -40...+105 °C. R.H. sensor operating temperature: -20...+80 °C for indoor probes (HP3517TC...) / -40...+105 °C for outdoor probes (HP3517WTC...). 14 mm diameter. Cable length 2, 5 or 10 m standard. 4-pole M12 connector.

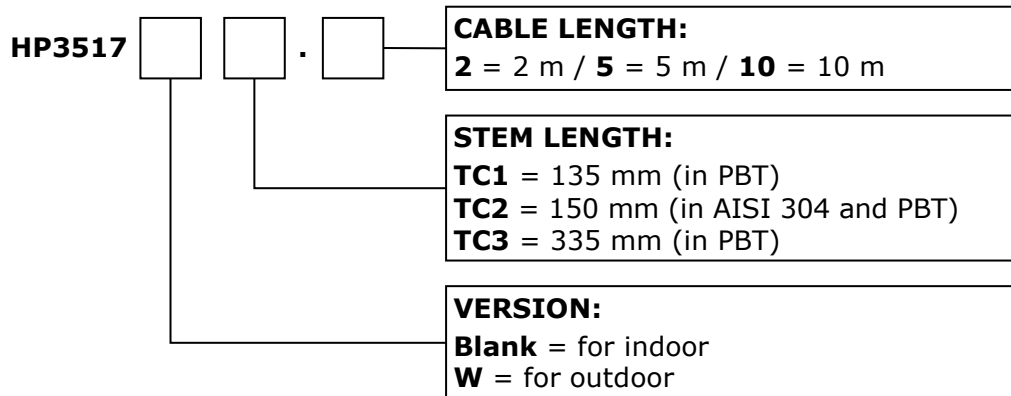

The outdoor installation of the HP3517... probe requires HD9007A-1 or HD9007A-2 protection against solar radiations.

The replacement of the HP3517... probe requires recalibration of the instrument in line with the new probe.

HD9007A-1 12-ring protection against solar radiations. Includes support bracket.

HD9007A-2 16-ring protection against solar radiations. Includes support bracket.

HD9007T26.2 Adapter for Ø 14 mm probes for protections against solar radiations HD9007A-1 and HD9007A-2.

TEMPERATURE PROBES

TP350N... NTC 10KΩ environmental temperature probe. Operating temperature: -40...+105 °C. 14 mm diameter. Cable length 2, 5 or 10 m standard. 4-pole M12 connector.

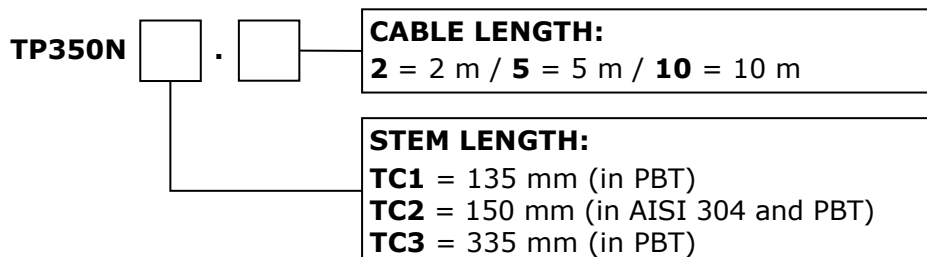

The outdoor installation of the TP350N... probe requires HD9007A-1 or HD9007A-2 protection against solar radiations.

TP35.1...

4-wire 1/3 DIN **Pt1000** temperature probe. Operating temperature: -50...+105 °C. Ø5 x 40 mm AISI 316 stainless steel tube. Cable length 3, 5 or 10 m standard. Cable ending with free wires or 4-pole M12 connector.

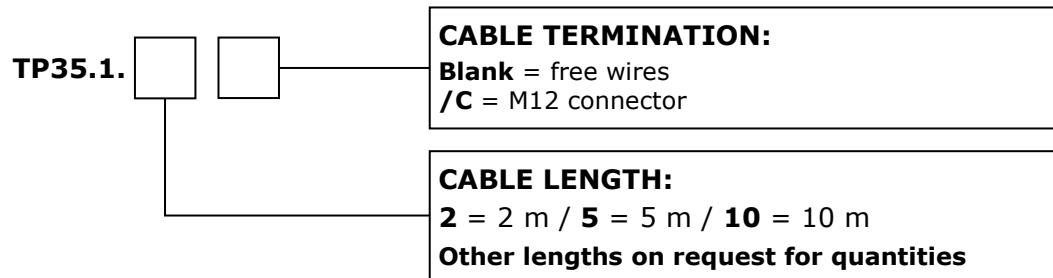
**TP35N1...**

NTC 10KΩ temperature probe. Operating temperature: -40...+105 °C. Ø5 x 40 mm AISI 316 stainless steel tube. Cable length 3, 5 or 10 m standard. Cable ending with free wires or 4-pole M12 connector.

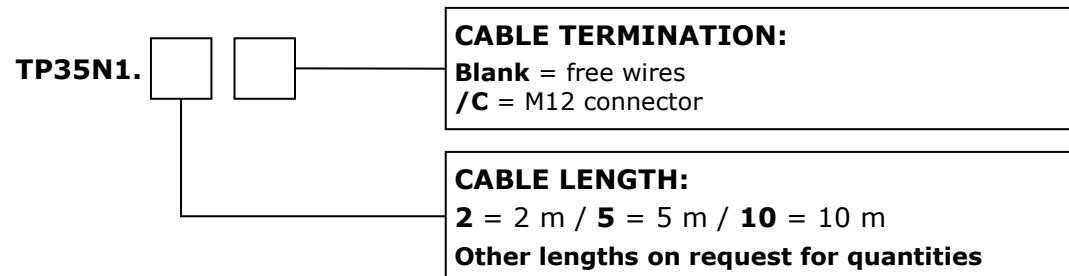
**TP35K6.5**

K-type thermocouple temperature probe. Operating temperature: -50...+750 °C. Ø3 x 150 mm AISI 316 stainless steel tube. Isolated junction. Cable length 5 m. Cable ending with free wires.

SOIL VOLUMETRIC WATER CONTENT SENSORS**HP3510.1...**

2-electrode probe for measuring the soil volumetric water content. With integrated NTC 10 kΩ temperature sensor. 5-pole M12 connector. 5 m (HP3510.1.5) or 10 m (HP3510.1.10) cable.

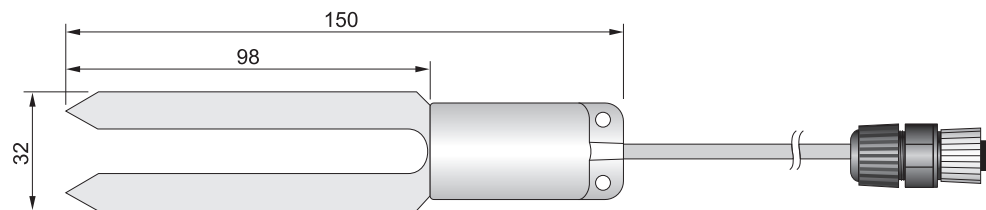
**HP3510.2...**

3-electrode probe for measuring the soil volumetric water content in restricted volumes. With integrated NTC 10 kΩ temperature sensor. 5-pole M12 connector. 5 m (HP3510.2.5) or 10 m (HP3510.2.10) cable.

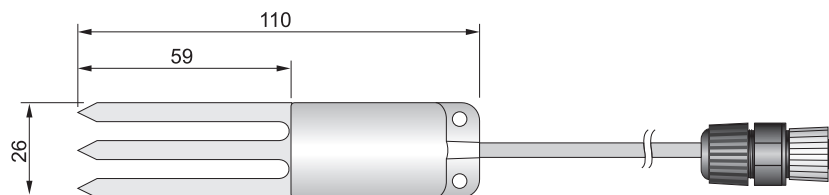

LEVEL SENSORS

HP712

Stainless steel level sensor. Measuring principle: detection of the pressure relative to the atmosphere. Measuring range 0...1 bar. Maximum overpressure 4.5 bar. Operating temperature -20...+80 °C. Protection degree IP 68. Resolution 0.1% f.s. Accuracy $\pm 0.8\%$ f.s. @ 25 °C. Cable ended with open wires.

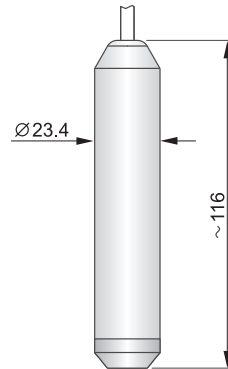

For rain gauges and pyranometers please visit www.deltaohm.com or contact Delta OHM directly.

ACCESSORIES

CP23

Direct USB connection cable with mini-USB male connector on the instrument side and A-type USB male connector on the PC side.

CPM12AA4...

Cable with 4-pole M12 connector on one side, free wires on the other. Length 2 m (CPM12AA4.2), 5 m (CPM12AA4.5), 10 m (CPM12AA4.10) or 20 m (CPM12AA4.20).

HD35.03

Spare plastic support for removable installation of indoor models.

HD35.11K

Pair of flanges in anodized aluminum alloy for fixed installation of indoor models. Lock pin and padlock included.

HD35.24W

Flange in anodized aluminum alloy for fixing to the wall the outdoor models.

HD35.24C

Kit including the HD35.24W flange and a clamp for fixing the flange to a $\varnothing 40...50$ mm mast.

HD35-BAT2

3.6 V size A Li-SOCl₂ **non rechargeable** battery, Molex 5264 2-pole connector. For all models except LR35WH and LR35WS...TC.

BAT-2013DB

3.6 V size C Li-SOCl₂ **non rechargeable** battery, 2-pole Molex 5264 connector. For LR35WH and LR35WS...TC.

HD75

Saturated solution to check Relative Humidity probes at 75 % RH, includes ring adapter for $\varnothing 14$ mm probes, thread M12 \times 1.

HD33

Saturated solution to check Relative Humidity probes at 33 % RH, includes ring adapter for $\varnothing 14$ mm probes, thread M12 \times 1.

DELTA OHM metrology laboratories LAT N° 124 are accredited ISO/IEC 17025 by ACCREDIA for Temperature, Humidity, Pressure, Photometry / Radiometry, Acoustics and Air Velocity. They can supply calibration certificates for the accredited quantities.

Approvals

Sub-GHz certifications:

Models LR35...**U/.AU** contain transmitter module FCC ID: VPYCMABZ
IC ID: 772C-CMABZ
ANATEL: 05650-18-08488

Models LR35...**AS** contain TELEC certified RF module: [R] 001-P01026



GUARANTEE



Member of GHM GROUP

TERMS OF GUARANTEE

All DELTA OHM instruments are subject to accurate testing, and are guaranteed for 24 months from the date of purchase. DELTA OHM will repair or replace free of charge the parts that, within the warranty period, shall be deemed non efficient according to its own judgement. Complete replacement is excluded and no damage claims are accepted. The DELTA OHM guarantee only covers instrument repair. The guarantee is void in case of incidental breakage during transport, negligence, misuse, connection to a different voltage than that required for the appliance by the operator. Finally, a product repaired or tampered by unauthorized third parties is excluded from the guarantee. The instrument shall be returned FREE OF SHIPMENT CHARGES to your dealer. The jurisdiction of Padua applies in any dispute.



The electrical and electronic equipment marked with this symbol cannot be disposed of in public landfills. According to the Directive 2011/65/EU, the european users of electrical and electronic equipment can return it to the dealer or manufacturer upon purchase of a new one. The illegal disposal of electrical and electronic equipment is punished with an administrative fine.

This guarantee must be sent together with the instrument to our service centre.

IMPORTANT: Guarantee is valid only if coupon has been correctly filled in all details.

Instrument Code: **LR35... series**

Serial Number _____

RENEWALS

Date _____

Date _____

Inspector _____

Inspector _____

Date _____

Date _____

Inspector _____

Inspector _____

Date _____

Date _____

Inspector _____

Inspector _____



The quality level of our instruments is the result of the constant development of the product. This may produce some differences between the information written in this manual and the instrument you have purchased. We cannot completely exclude the possibility of errors in the manual, for which we apologize.

The data, images and descriptions included in this manual cannot be legally asserted. We reserve the right to make changes and corrections with no prior notice.

V1.0
28/01/2021