

Differential pressure transmitter CP 111 – CP 112 – CP 113

KEY POINTS

- Ranges from -100/+100 Pa to -10000/+10000 Pa (according to models)
- Configurable intermediary ranges
- 0-10 V or 4-20 mA output, active, power supply 24 Vac/Vdc (3-4 wires) or 4-20 mA output, passive loop, power supply from 16 to 30 Vdc (2 wires)
- ABS V0 housing, IP65, with or without display
- "¼ turn" system mounting with wall-mount plate
- Housing with simplified mounting system
- Solenoid valve for auto-calibration (only on CP111 model)



FEATURES OF THE HOUSING

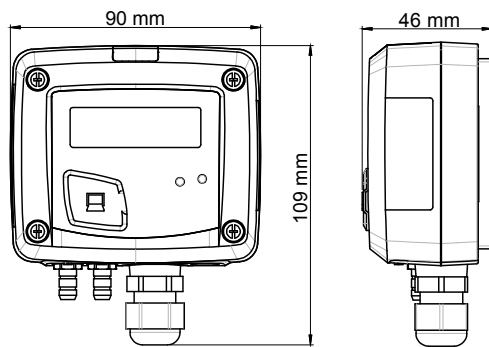

Material: ABS V0 as per UL94

Protection: IP65

Display: LCD 10 digits. Size: 50 x 17 mm

Height of digits: Value: 10 mm; Unit : 5 mm

Connections: ribbed, Ø6.2 mm

Cable gland: for cables Ø8 mm maximum

Weight: 143 g

TECHNICAL FEATURES

Measurement units	Pa, mmH ₂ O, inWG, mmHG, daPa, kPa, hPa, mbar
Accuracy*	CP111: ±1% of reading ±2 Pa; CP112: ±1.5% of reading ±3 Pa; CP113: ±1.5% of reading ±3 mmH ₂ O
Response time	1/e (63%) 0.3 s
Resolution	1 Pa; 0.1 mmH ₂ O; 0.01 mbar; 0.01 inWG; 0.01 mmHG; 0.1 daPa; 0.001 kPa
Autozero	Manual with push-button; Automatic by solenoid valve (only on CP111 model)
Type of fluid	Air and neutral gases
Overpressure tolerated	CP111/112: 21 000 Pa – CP113: 69 000 Pa
Conditions of use (°C/%RH/m)	From 0 to +50°C. In non-condensing condition. From 0 to 2000 m.
Storage temperature	From -10 to +70°C

*All the accuracies indicated in this technical datasheet were stated in laboratory conditions, and can be guaranteed for measurements carried out in the same conditions, or carried out with calibration compensation.

PART NUMBER

To order, just add the codes to complete the part number :

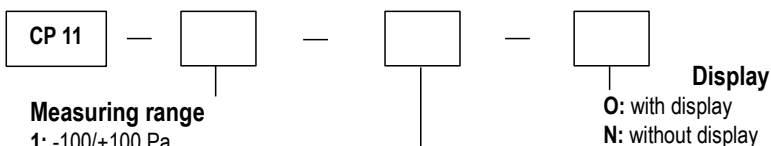

Power supply / Output

A: Active – 24 Vac/Vdc – 0-10 V or 4-20 mA

P: Passive – 16/30 Vdc – 4-20 mA (except the CP 111 which is not available in Passive).

Example: CP 113 – AO

Pressure transmitter measuring range -10 000/+10 000 Pa, 0-10 V or 4-20 mA active, with display

TECHNICAL SPECIFICATIONS

Output / Supply	- active sensor 0-10 V or 4-20 mA (alim. 24 Vac/Vdc $\pm 10\%$), 3-4 wires - passive loop 4-20 mA (power supply 16/30 Vdc), 2 wires - common mode voltage <30 VAC - maximum load: 500 Ohms (4-20 mA) / minimum load: 1 K Ohms (0-10 V)
Consumption	CP111: 3 VA (0-10 V) or 3 VA (4-20 mA) CP112 and CP113: 2 VA (0-10 V) or 0.6 VA (4-20 mA)
European directives	2014/30/EU EMC; 2014/35/EU Low Voltage; 2011/65/EU RoHS II; 2012/19/EU WEEE
Electrical connection	Screw terminal block for cables from 0.05 to 2.5 mm ² or from 30 to 14 AWG Carried out according to the code of good practice
Communication to PC	USB-mini DIN cable
Environment	Air and neutral gases

CONNECTIONS

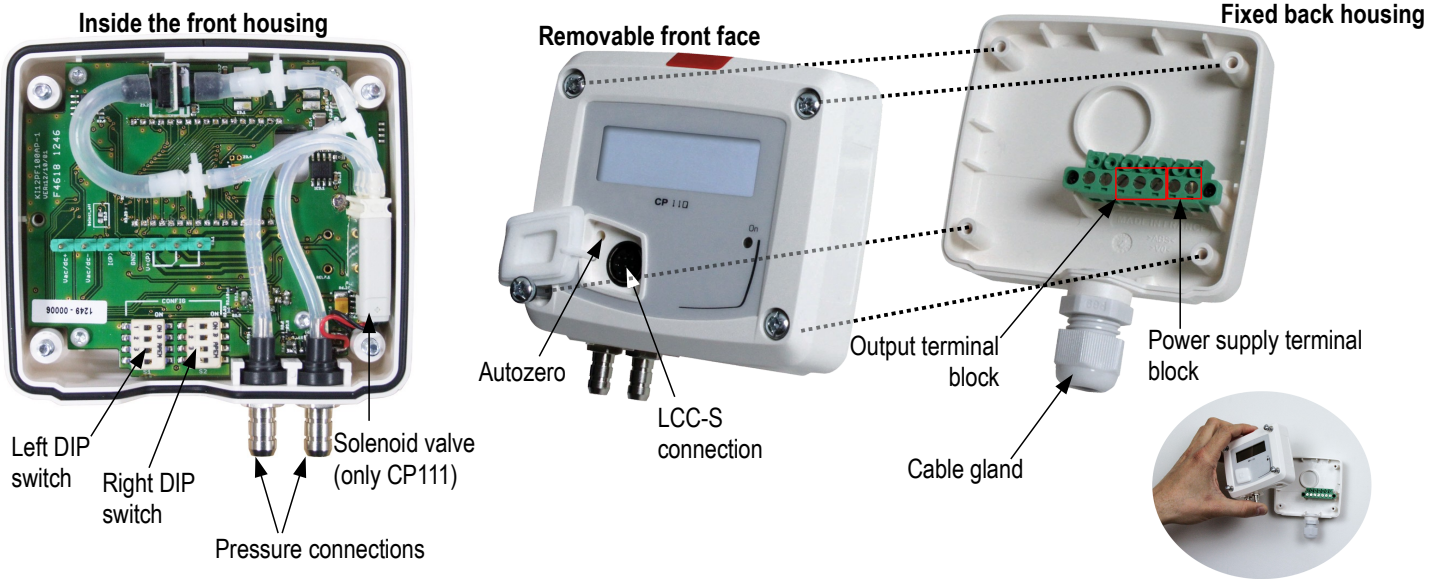

ELECTRICAL CONNECTIONS – as per NFC15-100 standard



This connection must be made by a qualified and trained technician. To make the connection, the transmitter must not be energized.

For CP111/112/113 – AO models and CP111/112/113 – AN models with 0-10 V or 4-20 mA output – active, 4 wires:



To make a 3-wire connection, before powering up the transmitter, please connect the output ground to the input ground. See drawing below.

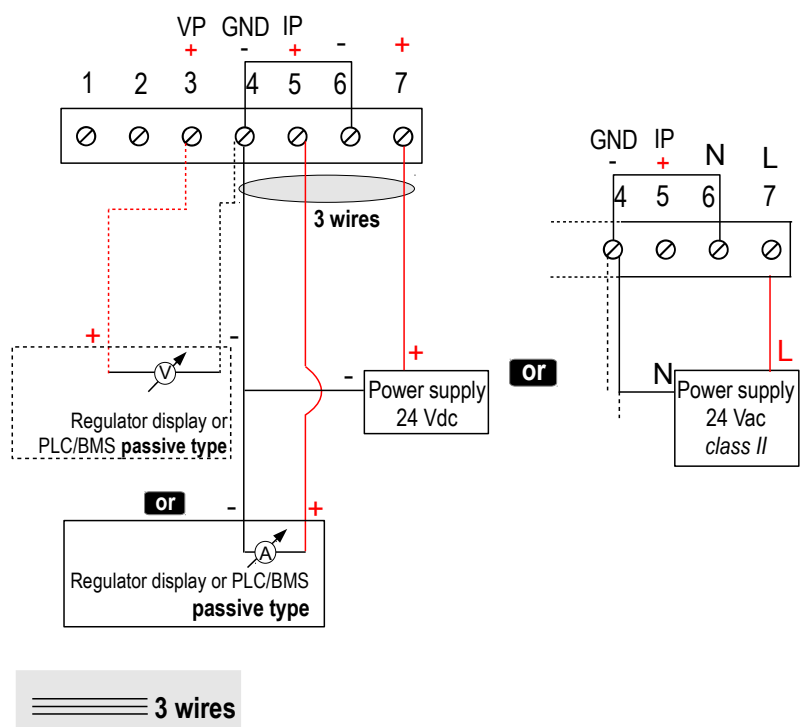
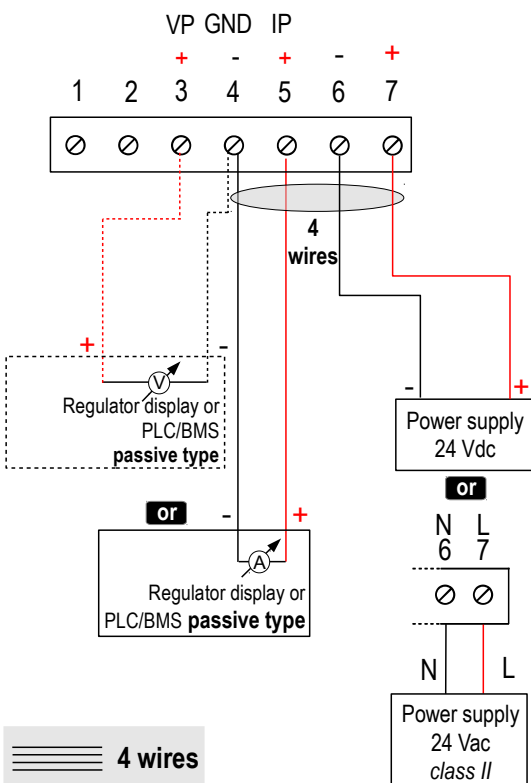

For CP112/113 – PO models and CP112/113 – PN models with 4-20 mA output – **passive** :

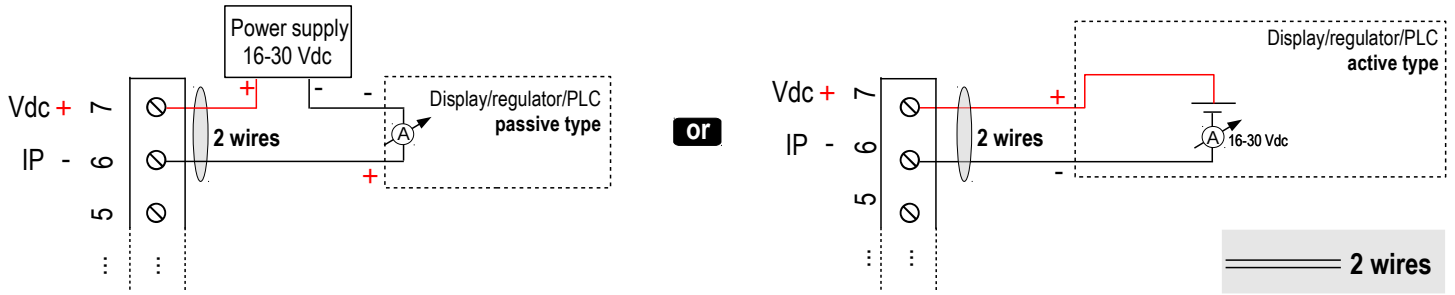

SETTINGS AND USE OF THE TRANSMITTER

> Auto-calibration

CP 111 pressure transmitter has a temperature compensation of the gain from 0 to 50°C and an auto-calibration process that guarantees over the time an excellent stability and a perfect reliability of the measurement on low and high ranges.

Auto-calibration principle: the microprocessor of the transmitter drives a solenoid valve that compensates the possible drifts on the sensitive element over the time. The compensation is performed by the permanent adjustment of the zero. So the measurement of the differential pressure is then independent from the environmental conditions of the transmitter.

Advantage: no drift

Frequency of auto-calibration: resetable or from 1 to 60 minutes

> Autozero

To perform an autozero, unplug the 2 pressure connections tubes and press the “**Autozero**” key.

On the CP111 transmitter, it is not necessary to unplug the 2 pressure connection tubes.

When an autozero has been performed, “**On**” green light turns off then turns on, and on transmitters equipped with a display, “**autoZ**” is displayed.

> Configuration



To configure the transmitter, it must not be energized. Then, you can make the settings required, with the DIP switches (as shown on the drawing below). When the transmitter is configured, you can power it up.

To configure the transmitter, unscrew the 4 screws from the housing then open it. DIP switches allowing the different settings are then accessible.

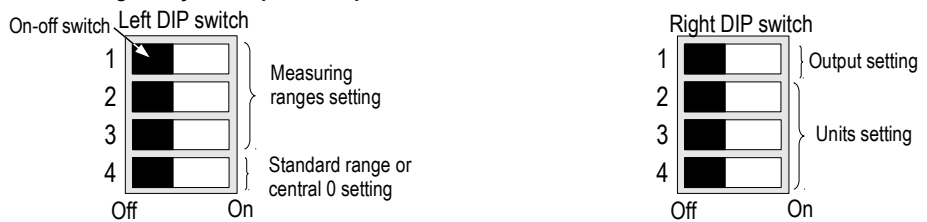

> Measuring range settings – left DIP switch

To set a measuring range, put the 1, 2 and 3 on-off switches as indicated in the table below.

Type of transmitter	Combination 1			Combination 2			Combination 3			Combination 4			Combination 5		
	CP111	CP112	CP113	CP111	CP112	CP113	CP111	CP112	CP113	CP111	CP112	CP113	CP111	CP112	CP113
Pa	20	100	1000	30	250	2500	40	500	5000	50	750	7500	100	1000	10000
mmH ₂ O	2.0	10.0	100.0	3.0	25.0	250.0	4.0	50.0	500	5.0	75.0	750.0	10.0	100.0	1000.0
mbar	0.2	1	10.00	0.3	2.5	25.00	0.4	5.0	50.00	0.5	7.5	75.00	1.00	10.00	100.00
inWG	0.08	0.40	4.00	0.12	1.00	10.00	0.16	2.00	20.00	0.20	3.00	30.00	0.40	4.00	40.00
mmHg	0.20	0.80	8.00	0.22	2.00	20.00	0.30	4.00	40.00	0.40	6.00	60.00	0.80	8.00	80.00
daPa	2.0	10.0	100	3.0	25.0	250.0	4.0	50.0	500.0	5.0	75.0	750.0	10.0	100.0	1000.0
kPa	0.020	0.100	1.00	0.030	0.250	2.50	0.040	0.500	5.00	0.050	0.750	7.50	0.100	1.000	10.00
hPa	0.20	1.00	10.00	0.30	2.50	25.00	0.40	5.00	50.00	0.50	7.50	75.00	1.00	10.00	100.00

- Measuring ranges of the **CP111 transmitter** on the **±100 Pa range** according to the measurement unit
- Measuring ranges of the **CP112 transmitter** on the **±1000 Pa range** according to the measurement unit
- Measuring ranges of the **CP113 transmitter** on the **±10 000 Pa range** according to the measurement unit.









Example:

- From 0 to 750 mmH₂O, measuring range is 750 mmH₂O.
- From -500 Pa to +500 Pa, measuring range is 1000 Pa.

> **Standard range / central zero setting – left DIP switch**

To set the type of measuring range, put the on-off switch 4 as indicated beside:

Example 0-100 Pa: Full scale / 0  (0 / 100 Pa)
Central zero  (-50 Pa / 0 / +50 Pa)









Configurations	Full scale	Central zero
Combinations		
		
		
		



Please follow carefully the combinations beside with the DIP switch. If the combination is wrongly done, the following message will appear on the display of the transmitter "CONF ERROR". In that case, you will have to unplug the transmitter, place the DIP switches correctly, and then power the transmitter up.











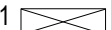
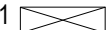
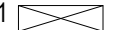
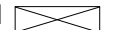
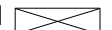
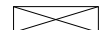
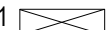
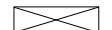













> **Output setting – right DIP switch (CP111/112/113 – AO and CP111/112/113 – AN models)**

To set the type of analogue output, please put the on-off switch of the output as shown beside.

Configurations	4-20 mA	0-10 V
Combinations	1 	1 
	2 	2 
	3 	3 
	4 	4 

> **Units setting – right DIP switch**

To set a measurement unit, put the on-off switches 2, 3 and 4 of the units as shown in the table below.

Configurations	Pa	mmH ₂ O	mbar	lnWG	mmHG	daPa	kPa	hPa
Combinations	1 	1 	1 	1 	1 	1 	1 	1 
	2 	2 	2 	2 	2 	2 	2 	2 
	3 	3 	3 	3 	3 	3 	3 	3 
	4 	4 	4 	4 	4 	4 	4 	4 

CONFIGURATION VIA LCC-S SOFTWARE (option)

An easy and friendly configuration with the software!

You can configure your own intermediary ranges.

Caution : the minimum difference between the high range and the low range is 20.

For example, it is possible to set the instrument from -20 to 0 Pa, from 0 to +20 Pa, or from -10 to +10 Pa...

• To access the configuration via software:









- Set the DIP switches as shown beside. *Nota: the on-off switch 1 of the right DIP switch can be in any position (selection of the analogue output 0-10 V or 4-20 mA)*

- Connect the cable of the LCC-S to the connection of the transmitter.

• Please refer to the user manual of the LCC-S to make the configuration.

Caution: the configuration of the parameters can be done either with the DIP switch or via software (you can not combine both solutions).

Configuration via PC

1 	1 
2 	2 
3 	3 
4 	4 

Left DIP switch

MOUNTING

To mount the transmitter, mount the ABS plate on the wall (drilling : Ø6 mm, screws and pins are supplied).

Insert the transmitter on the fixing plate (see A on the drawing beside). Rotate the housing in clockwise direction until you hear a "click" which confirms that the transmitter is correctly installed.



Once the transmitter is installed and powered up, please make an autozero to guarantee the correct working of the transmitter in any position.

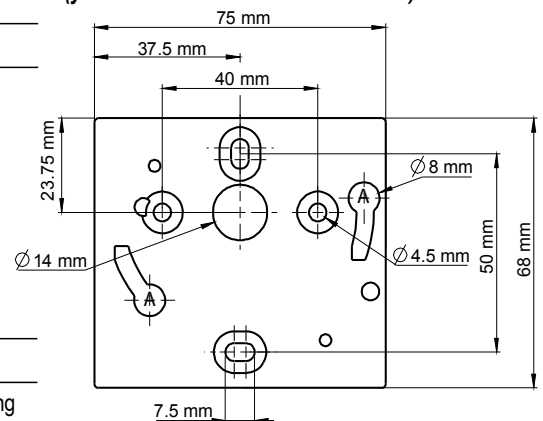

MAINTENANCE

Please avoid any aggressive solvent. Please protect the transmitter and its probes from any cleaning product containing formalin, that may be used for cleaning rooms or ducts.

OPTIONS AND ACCESSORIES

- KIAL-100A: Power supply class 2, 230 Vac input, 24 Vac output
- KIAL-100C: Power supply class 2, 230 Vac input, 24 Vdc output
- LCC-S: configuration software with USB cable
- Connection tube
- Connection fittings
- Through-connections
- Straight connections
- Spherical coupling nut

 **Only the accessories supplied with the device must be used.**

PRECAUTIONS FOR USE

Please always use the device in accordance with its intended use and within parameters described in the technical features in order not to compromise the protection ensured by the device.



Once returned to KIMO, required waste collection will be assured in the respect of the environment in accordance with European guidelines relating to WEEE.

www.kimo.fr

Distributed by :



EXPORT DEPARTMENT
Tel : + 33. 1. 60. 06. 69. 25 - Fax : + 33. 1. 60. 06. 69. 29
e-mail : export@kimo.fr